

RCA Engineer

Vol 24|No 4 Dec 1978|Jan 1979

RCA Engineer

A technical journal published by
 RCA Research and Engineering
 Bldg. 204-2
 Cherry Hill, N.J. 08101
 Tel. 222-4254 (609-338-4254)
 Indexed annually in the Apr/May issue.

RCA Engineer Staff

Mike Geverd	Editor
Bill Lauffer	Associate Editor
Joan Toothill	Art Editor
Frank Strobl	Contributing Editor
Betty Gutchigian	Composition
Dottie Snyder	Editorial Secretary

Editorial Advisory Board

Harry Anderson	Div. VP, Mfg. Operations, Consumer Electronics Div.
Jay Brandinger	Div. VP, SelectaVision VideoDisc Operations
John Christopher	VP, Tech. Operations, RCA Americom
Bill Hartzell	Div. VP, Engineering, Picture Tube Division
Jim Hepburn	VP, Advanced Programs RCA Globcom
Hans Jenny	Manager, Technical Information Programs
Arch Luther	Chief Engineer, Commercial Communications Systems Div.
Howie Rosenthal	Staff VP, Engineering
Carl Turner	Div. VP, Integrated Circuits, Solid State Division
Bill Underwood	Director, Engineering Professional Programs
Joe Volpe	Chief Engineer, Missile and Surface Radar
Bill Webster	VP, Laboratories

Consulting Editors

Ed Burke	Ldr., Presentation Services, Missile and Surface Radar
Walt Dennen	Mgr., News and Information, Solid State Division
Charlie Foster	Mgr., Scientific Publications, Laboratories
John Phillips	Mgr., Proposals and Publicity, Automated Systems



Our cover shows some of the manufacturing processes and finished subassemblies that eventually become part of a finished color television receiver. Moving left to right from the upper left-hand corner, we have: printed-circuit module assembly and a finished chassis, Juarez, Mex.; printed-circuit board printing and a finished board, Indianapolis, Ind.; ferrite core grinding and a finished deflection-yoke core, Indianapolis, Ind.; ripsawing and finished wood cabinet, Monticello, Ind.; final assembly and ready-to-ship cartons, Bloomington, Ind.

- To disseminate to RCA engineers technical information of professional value
- To publish in an appropriate manner important technical developments at RCA, and the role of the engineer
- To serve as a medium of interchange of technical information between various groups at RCA
- To create a community of engineering interest within the company by stressing the interrelated nature of all technical contributions
- To help publicize engineering achievements in a manner that will promote the interests and reputation of RCA in the engineering field
- To provide a convenient means by which the RCA engineer may review his professional work before associates and engineering management
- To announce outstanding and unusual achievements of RCA engineers in a manner most likely to enhance their prestige and professional status.

Manufacturing technology— getting back to the top

The once highly regarded manufacturing technology and productivity of the United States is now being seriously challenged and threatened by competitors world-wide. This is clearly evidenced by the strong international competition for our own domestic markets as well as our weakening position in marketplaces overseas. This situation demands our manufacturing organizations to significantly increase overall productivity—*now*.

This urgent need does not call for a manufacturing revolution but rather for an evolution, a *change* in tempo, resulting in an ever increasing *rate* of improvement in our productivity; we must do more—*faster*. We can improve our productivity substantially only by developing and effectively applying new technology to our manufacturing systems. We need to increase our investment, therefore, not only in new and improved manufacturing facilities, but also, and perhaps more importantly, in the development of new manufacturing technology.

Not only must we develop new technologies, we must also fully use the ones currently available to us. Two that come instantly to mind are robotics and computer technology. Both are available now, but the use of computers and computer technology in our manufacturing systems, for example, is just in its infancy, especially when compared with the very extensive use of computers in the traditional data-processing functions of our businesses. Unlimited opportunities (and great challenges) lie in applying computer technology to all aspects of manufacturing: process monitoring and control, operating and controlling production equipment, data collection and analysis, product evaluation and troubleshooting, to name a few. Computer technology may well provide the near-term vehicle we need to optimize our current processes and operations, helping us increase our rates of improvement in our overall manufacturing productivity.

RCA is now augmenting its overall capability in manufacturing, not only by expanding its funding for mechanizing and automating our production facilities, but also through *expanding* and strengthening the manufacturing-technology groups in the product divisions and at RCA Laboratories. This effort has made today a stimulating, rewarding, and exciting time in RCA's manufacturing arenas.

The need for change and improvement in RCA's and the country's manufacturing technology is real and clear. We must significantly improve our productivity to meet world-wide competition and once again assume a position of leadership in the world.



A handwritten signature in cursive script that reads "H Anderson". The signature is written in dark ink on a white background.

Harry Anderson
Division VP, Manufacturing Operations
Consumer Electronics Division
Indianapolis, Ind.

Manufacturing engineering

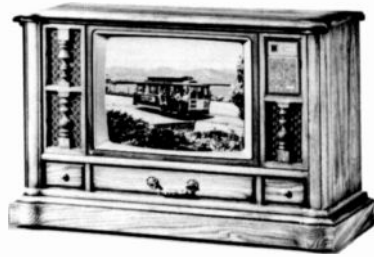

behind the scenes

Manufacturing engineers turn television designs into realities. What's involved?

12, 42



components into chassis

Each day, RCA's Juarez plant turns seven million components into six thousand color tv chassis.

22



automation at work

Basic changes in the printed-circuit production and testing process have doubled the screening rate and increased quality.

19

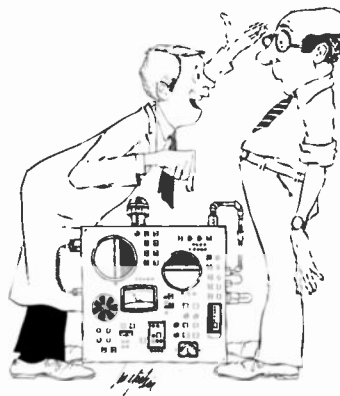

two different worlds?

There's a right way and a wrong way to move a good idea from the lab to the factory. The difference can mean success or failure.

4

RCA Engineer

Vol. 24|No. 4 Dec 78|Jan 79

- C.W. Mueller 4 Ion implantation—physics laboratory to factory floor
- Consumer Electronics manufacturing**
- J.S. Race 10 Productivity: fighting the cost squeeze
- G.L. Apple|G.A. Laskaris 12 Color television final assembly: quality and quantity
R.D. Veit
- J.R. Arvin 19 Automated system increases quality and production of
printed-circuit boards
- H. Barrio 22 Components to boards to chassis: subassembly manufacturing for color tv
- B.L. Borman 28 Automatic testing—the way to build a better tv chassis for less money
- J.R. Smith|J.D. Eaton 34 CE's Quality Assurance Program produces quality television sets
H.E. Elrod|D.H. Slider
- A.E. Bowman 38 The puzzle of the wood television cabinet
- R.M. Orman|A.M. Tinsley 42 Design to production: preparing the manufacturing process
- W. Binder 47 The ferrite story
- R.M. Smith|V.E. Adcock 50 Material flow—components in, finished product out
R.R. Hunter
- general interest**
- J.R. Richards|W.F. Meeker 55 Conferencing in digital speech communication networks
A.L. Nelson
- E.V. Fitzke 60 Prototype manufacturing in research and development
- L. Rarig|W.R. Kelly 64 Equipment development—the vital link
- on the job/off the job**
- J.C. Hartmann|S.M. Zollers 68 This is WR2AJC, Princeton, New Jersey
- departments**
- 73 Dates and Deadlines
- 74 Patents
- 76 Pen and Podium
- 78 News and Highlights
- 80 IEEE Fellows

Ion implantation— physics laboratory to factory floor

C.W. Mueller

Researchers often assume that a process that works well in the laboratory will automatically work well in the factory. It's not that easy at all.

Today's widespread use of ion implantation in semiconductor manufacturing is an example of a complex developmental process that started as pure physics in the particle accelerator laboratories. Over a period of many years, the process has been developed to the point where practically all integrated circuits are now made with one or more ion-implantation steps. RCA now has 11 ion-implant machines at the six of its

locations concerned with semiconductor processing. Since these machines are expensive, costing from \$125,000 to \$400,000 apiece, it is obvious that their use in all these locations was technically and economically advantageous or they would not have been installed.

A great deal of research and development work was necessary in the late 1960s and

the early 1970s before the ion implantation process moved from the nuclear physics laboratories to the production floor. This paper briefly mentions some of the early history of the ion implantation process,^{1,2} discusses the work necessary to transfer this new and different technology to the production floor, and presents an example showing its economic and technical benefits.

Early research history

Research on ion implantation, or "radiation damage" as it was originally called, began in the 1940s in the physics laboratories of universities and special government laboratories. The early research used particle accelerators to study the penetration and interaction of the accelerated ions with metals that might be used for nuclear reactors. No research on semiconductors was done for many years. In the 1960s, though, the possibilities of using ion implantation for electron devices became more promising, and research work on semiconductors was started in laboratories.¹

Early conferences on the subject mainly discussed the physics of ion implantation, but in October 1971 at the IEEE Electron Devices Meeting at Washington, important papers showed laboratory results of the promise of ion implantation in devices. However, there is a great deal of difference between demonstrating a principle in the laboratory and using the process routinely on the production floor, especially a completely new technique that requires expensive high-voltage equipment. The following section discusses the important

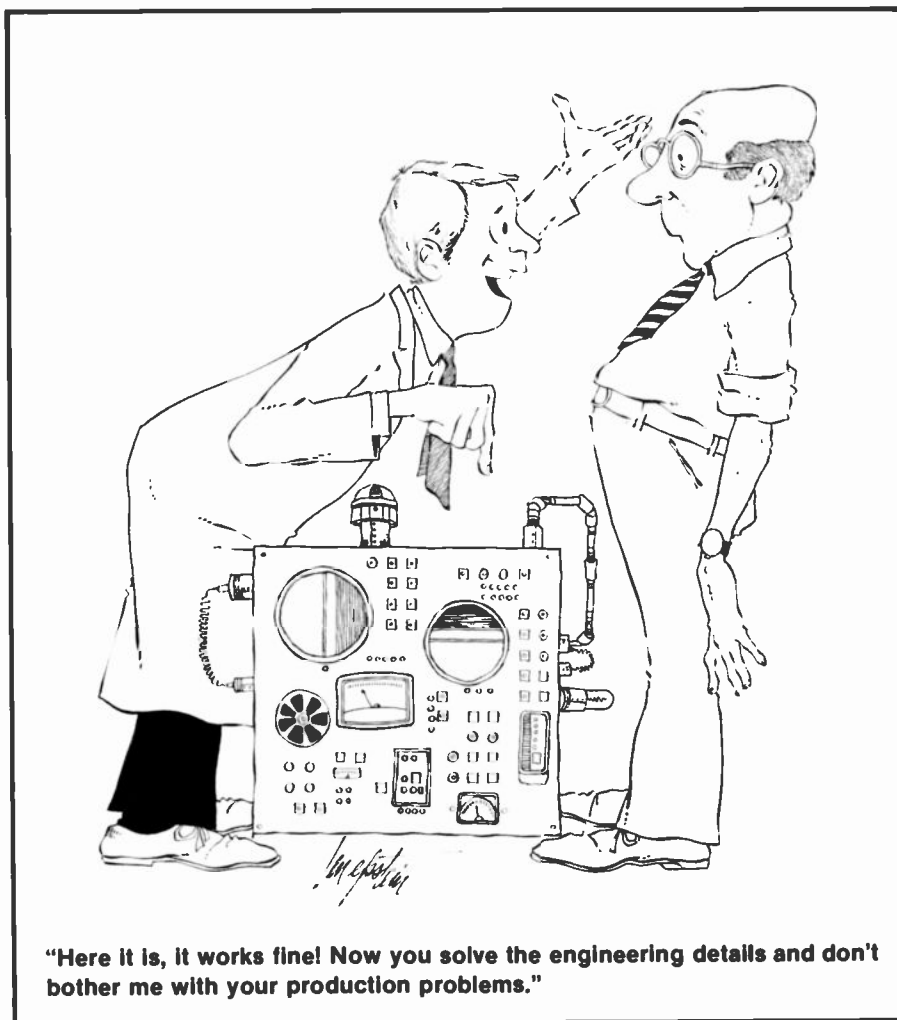

"Here it is, it works fine! Now you solve the engineering details and don't bother me with your production problems."

Reprint RE-24-4-15

Final manuscript received September 6, 1978. This article is a condensation of a study sponsored by The National Science Foundation on "Contributions of Basic Research to Successful Industrial Innovations."

factors that are necessary to put a good idea into economical industrial use.

Factors in commercial development

The existence of a true industrial manufacturing need can greatly change the speed of introducing a new process.

With regard to the general field of ion implantation, need is an interesting factor that played an important part in the development of industrial applications. The extreme accuracy and uniformity of ion implantation was not originally extolled as an attribute; in fact, it was hardly mentioned by ion implantor sales engineers in the late 1960s. One reason for this was that the semiconductor industry did not need high accuracy for manufacturing the bipolar transistors in use at these early dates. Also, allowable limits of electrical device characteristics tend to be set to a large extent by the results achievable in the factory.

In the mid-1960s the MOS unipolar or field-effect transistor was just being developed and its future as a product line was still uncertain. Also at this time, commercial ion implantation was developing very slowly; the widespread commercial use of this technique was not at all certain as well. However, the semiconductor industry is a very dynamic one, the competition is intense, and the sophistication of the technology advances very rapidly. Therefore, when the MOS transistor began to assert its position as a very convenient building block for integrated circuits, MOS manufacturing methods rose in importance. Control of MOS threshold voltages, an important characteristic, places severe requirements on controlling the concentration of the doping elements added to the silicon. This was a made-to-order application for ion implantation—a need for high accuracy when inserting a very small number of doping ions.

Before factory use of an innovation can be adopted, a cost-effective machine is necessary.

Complicated new machines such as ion-implantors are usually built by specialized concerns for the members of the semiconductor industry. The early ion implant machines were assembled by physicists from purchased parts when available, such as vacuum pumps and vacuum line connec-

Why use ion implantation?

Doping, the process of inserting an exact number of impurity atoms into a silicon wafer, may occur several times during the manufacture of an integrated circuit. The impurities, typically boron, arsenic, or antimony, must be tightly limited to one atomic species. In certain applications, such as CMOS integrated circuits, control of one part of 10^9 is necessary. This level of accuracy is extremely difficult to maintain continuously from day to day with the older chemical-vapor or liquid methods.

Ion implantation offers an ideal solution to these accuracy and purity problems. It works by bombarding the surface of the wafer with a beam of impurity ions. Absolute purity of the beam is assured because magnetic separation selects only a single atomic species for the implantation beam. Control of the number of ions inserted is also very tight. Continuous electrical measurements determine the cumulative number of atoms implanted during the processing and when the dialed-in number is reached, the ion beam shuts off. This process is very cost-effective because the usual time-consuming probe measurements of control wafers are not necessary. Uniform deposition is assured because the ion beam sweeps continuously over the wafer surface.

Consequently, ion implantation gives greater accuracy (fewer rejected integrated circuits) and is less expensive because direct labor charges are reduced. However, as the accompanying article indicates, these advantages did not make its acceptance automatic.

tors. The remainder of the equipment was designed and built to order in the laboratory shops. Needless to say, physicists and engineers of necessity spent a great deal of time maintaining these ion implantors. Continuous operation for many shifts was unthinkable because no production supervisor would have allowed these machines on a transistor production floor.

The demand for scientific accelerators interested some specialized companies in supplying parts and then actually assembling complete machines for sale. Some companies who were building high-voltage electron accelerators became interested and designed machines for sale in the period 1965 to 1970, but no semiconductor manufacturers were interested in buying or using the ion implant machines. Why?

Before 1970 I heard several different accelerator-company engineers describe their machines and the characteristics of the ion-implanted transistors they had made. Unfortunately, these transistors, which were always bipolar devices, never offered any new or better electrical characteristics than commercially available devices. In fact, the devices usually were one to two years behind the results that could be obtained with the best state-of-the-art bipolar technology. The ion implantors were cumbersome and slow; consequently, the process was expensive. The implantation machines represented dangers to personnel from X-ray radiation and high voltage. They required large amounts of floor space and frequently broke down. Under these conditions, device research or development engineers would not even try to sell their

Very frequently the factory engineer in charge of production does not have the time to understand a radical new technique; he would rather struggle and try to improve a familiar process.

managements the idea that research on device-oriented, ion-implantation experiments could possibly be worthwhile. So, in the early years the ion implantors were not ready for the factory floor and the factories had no pressing need for them.

Since the actual sales of ion implantors on a reasonable scale was not developing and future possibilities were hard to predict, some of the companies that had originally developed ion implantation machines gave them up. Fortunately, some of their engineers organized other small companies that continued development and, beginning about 1970, implant machines were sold to laboratories and development groups that applied them solely to ion implantation in silicon. A few companies put ion implantors on small production lines for MOS transistors where, at that time, they fitted economically.

Development speeded up immensely as engineers using ion-implant machines in semiconductor plants began to feed back information to implantor designers in their shops. Improvements were especially rapid in terms of building machines that had the safety, ruggedness, and speed that made ion implantation cost-effective on the production floor. Irate telephone calls complaining about production lines being down had a great effect on eliminating equipment bugs. When, as will be discussed later, production-line implantation tests

Irate telephone calls complaining about production lines being down had a great effect on eliminating equipment bugs.

began to show products that demonstrated a cost advantage, the placing of ion implantors in factories began to increase rapidly. From 1970 to 1975 the worldwide sales of production ion-implantation equipment increased about 100 times to 10 million dollars.³ Sales of ion implantors in 1977 were estimated at 20 to 25 million dollars.

Research scientists frequently overlook the large amount of work necessary to introduce a new technique to the production floor.

Very frequently the factory engineer in charge of production does not have the time to follow, study, and understand a radical new technique like ion implantation. Consequently, this man would rather struggle and try to improve the process he is familiar with than to introduce something new and unfamiliar. Under these conditions, the role of the research or development engineer becomes crucial. The research engineer must first assimilate the appropriate science from the literature, and perform various experiments to become familiar with experimental

practice and the various tradeoffs. He must then understand the production engineer's problems and have the right attitude to sympathize with and guide the production engineer. If a change in processing is suggested, a careful consideration of all alternatives and their possible effects is necessary.

A particularly deadly approach occurs when the scientist essentially says to the factory engineer, "Here is the process, it works! Now you solve the engineering details and don't bother me with production problems." What often happens is that the production engineer runs tests and very frequently the data tell him that the new process of ion implantation is worse than the method he is now using. The reasons for failure may be real, or perhaps the experiments were not properly coordinated, as happens in so many cases of putting an ion-implantation step into a 150-step integrated-circuit process. That is, a step before or after the ion-implantation step may not be compatible and may negate the achievement of the desired results.

(left to right)

Laboratory version, factory version and diagram of laboratory version of ion-implantation machine. Production problems are not the same as laboratory problems, hence the differences. In the diagram, ions are produced at the source and accelerated to a high voltage, magnetically "switched" into the appropriate beam line, and focused, before striking the target wafers.

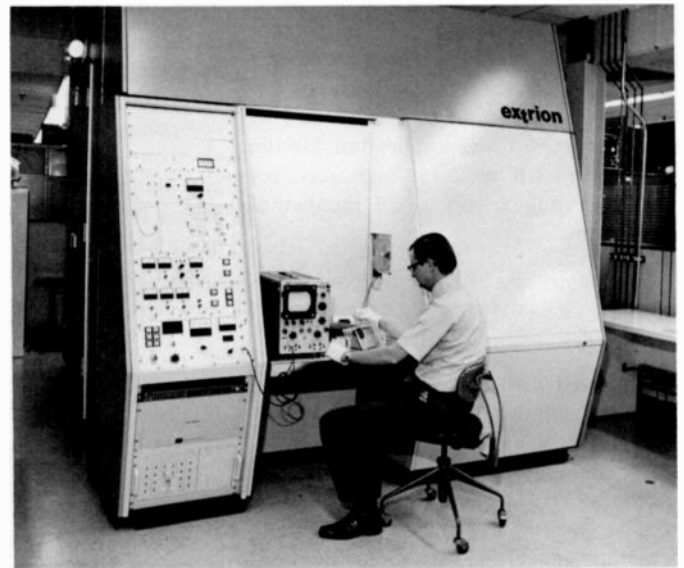
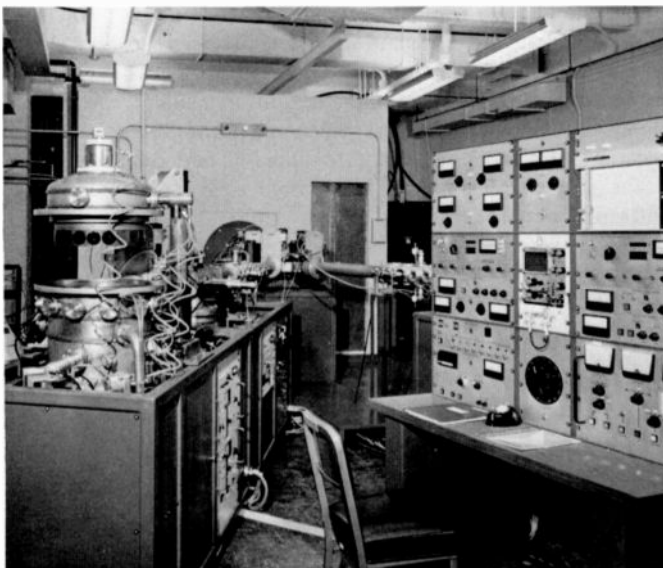

Sometimes the variations in other parts of the process are very large and have not been recognized as possible sources of error.

The transfer of a process from a research or development group to the factory must be a continuing process in which there is constant feedback. In order to make the entire process compatible, new implantation steps must be properly tailored and adjustments must be made in the older processing steps. With care and patience, the factory engineer can avoid many experiments if the effects of plus and minus variations on the final product are known. Cooperation to solve problems will ultimately improve the product and the yield of good devices. The final result of making a better product at a lower cost is necessary to satisfy the customer and thereby stay in business.

Ion implantation at RCA

Ion implantation was initially considered only as a research tool.

Early discussions about the uses of ion implantation in RCA Laboratories usually explored or emphasized the possible uses of ion implantation as a means of doing material modifications that could not be obtained by conventional methods used in industry. For instance, diffusion methods could not produce a profile of impurity

No matter what the reasons for failure, the new process will get the blame.

ions that varied in its vertical spatial distribution in a way that increased the variation of capacitance with voltage. Also, most production engineers felt that gaseous furnace diffusion of impurities was too inexpensive to be replaced in any manner by ion implantation. (However, later tests showed that, in many cases, ion implantation can be the least expensive overall method.)

Another area of research exploration frequently mentioned was the doping of III-V or II-VI semiconductor compounds; implantation made ions available for doping for which there was no developed simple chemical or gaseous method of doping available. Although there is still a considerable amount of research work being done concerning the doping procedures and results in base materials other than silicon, no large-scale commercial application has developed as yet.

The decision to invest in an ion-implantation machine and to commit the necessary research staff was particularly

difficult for RCA Laboratories because money for capital expenditures was very tight in 1971-72, the time the final decisions were being made. Fortunately, the RCA Laboratories management was far-sighted enough to continue the project, purchase an ion-implantation machine⁴ for \$125,000, and commit the space (a lead-shielded room) and personnel needed for this research. The project was justified at the time as a general research method rather than the solution of a particular problem. Later results, of course, showed that the commitment paid off handsomely, but the decision was far from obvious in the atmosphere that prevailed when the decision had to be made.

Cost effectiveness must be a distinct possibility before factory tests can begin.

A small amount of arithmetic can show if a new process has a chance of succeeding in the factory. However, certain assumptions must always be made in these calculations, and the correctness of the assumptions must be proven and the overall results demonstrated. If the process is going to continually cost even a small incremental amount (installation and learning time are one-time costs), you might as well forget about it. The key word here is demonstrable. This means that you must be able to show, with hard, clear facts, what the ion implantation has accomplished. This also means that the test must be carefully done. Even if the results are negative or inconclusive for reasons that have nothing to do with ion implantation, the overall results may as well be bad, because ion implantation will be blamed for the failure. This may cause the tests to be wholly abandoned and certainly lower the enthusiasm for further careful tests. If it turns out that an implantation step adds to the overall unit price, the final product must be in some way improved so that the customer is willing to pay more.

After laboratory experiments show feasibility, a large-scale test must be planned and one must proceed with patience. The first production job for ion implantation in a factory must be carefully chosen. The particular process should be one in which the production engineer finds

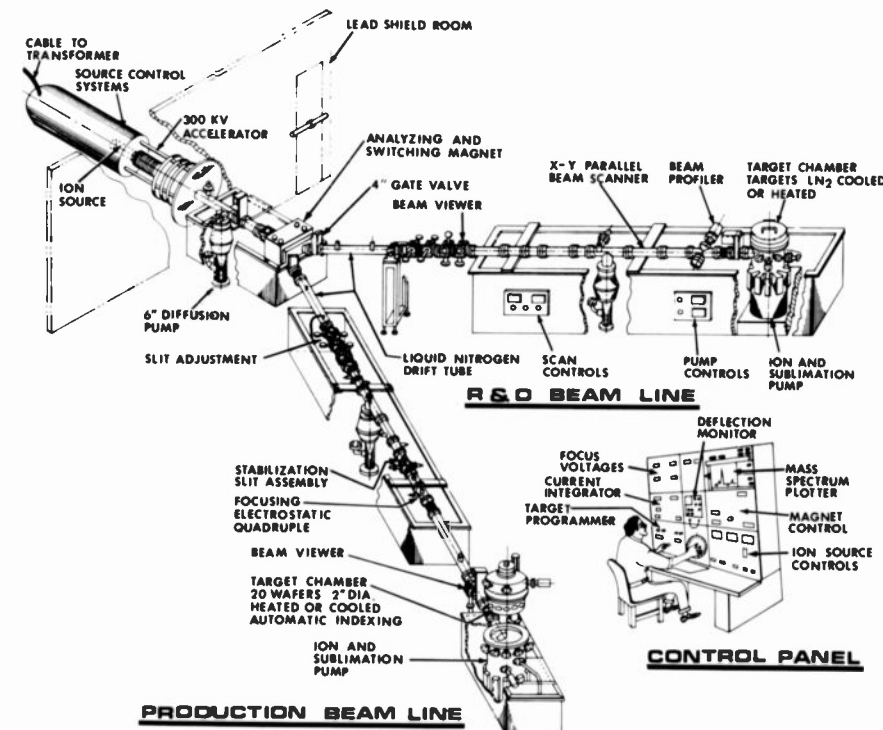

A process that works under laboratory conditions, but cannot be made to work in the factory, is of no use in the commercial world.

it a struggle to get continuous yields of good product. Small-scale experiments must be used to develop the process and determine the necessary process parameters for device production. Examples of these parameters include appropriate masking technique, number and kind of atoms implanted, accelerating voltage, and annealing treatment. Careful electrical tests must be conducted to see that the devices and circuits have the correct electrical characteristics. One must make sure that both major and minor electrical characteristics are satisfactory and have not shifted out of the center of the range of acceptance. It is highly important to show

that the frequently subtle characteristic of device life is satisfactory. The device must be tested for several thousand hours under maximum allowable stress conditions to make sure that the electrical characteristics do not change so much that the circuit becomes inoperative or even just occasionally erratic.

Many scientists assume that once some process is accepted as superior in the laboratory it will more or less automatically be adopted for use in manufacturing. It is not so easy; in fact, it takes about ten times as much work to introduce a new process to a manufacturing line as it does to

demonstrate that it works on a small, carefully controlled experiment in the laboratory.

Full-scale runs showed ion implantation's advantages.

Before a process is accepted or signed off by the various responsible production managers, it must be tested in the factory line with a reasonably large product run. A process that works in the laboratory under laboratory conditions and then cannot be made to work in the factory is of no use in the commercial world and all the time wasted in its development just contributes to the overhead cost of the product actually sold. The research engineer should bring the factory engineer into the test at the very beginning of the planning; continuing discussions help to educate both the production engineer on ion implantation and the research engineer on the particular requirements of the overall process.

The particular application chosen at RCA for the initial introduction of ion implantation to production was a difficult part of the CMOS (Complementary Metal Oxide Semiconductor) transistor process. The requirements were ideal for ion implantation: highly accurate control of a low-concentration impurity dose for p-well fabrication in the integrated circuit.

The research engineer must understand the production engineer's problems and have the right attitude to sympathize with and guide the production engineer.



Charlie Mueller, a Fellow of RCA Laboratories, has been strongly involved with ion implantation as a research tool and as production equipment.

Contact him at:
RCA Laboratories
Princeton, N.J.
Ext. 2024

Step Operation

- 1W Standard clean/1100°C, 90 min
- 2W Initial oxide
- 3W Apply photo
- 4W Expose well mask
- 5W Develop
- 6W Inspect
- 7W Bake photo well
- 8W Buff HF etch
- 9W Rinse
- 10W Add well control
- 11W Boron deposition/£00°C, 30 min
- 12W Glass removal
- 13W Read well control
- 14W First drive/1100°C O₂, 60 min
- 15W Buff HF etch
- 16W Rinse
- 17W Read well control
- 18W Second drive/1100°C steam, 4 hr
- 19W Oxide etch
- 20W Read well control
- 21W Third drive/16 hrs 1200°C
3 hrs O₂, 13 hrs N₂

Ion implantation
2.4 x 10¹³ boron ions/cm², 100 keV

Table I
Ion-implantation test eliminated eleven processing steps (shown in gray). When wafers were reinserted in line after implanta-

tion, they went through the normal procedure for the rest of the process. Results are in Table II.

It takes about ten times as much work to introduce a new process to a manufacturing line as it does to demonstrate that it works on a small, carefully controlled, experiment in the laboratory.

The following data shows the results of a production-line test of p-well fabrication. The dramatic effects of the ion-implantation method on the overall process can best be shown by reproducing the factory flowchart (Table I) and the test results. The table shows the actual factory processing flowsheet with the standard steps from 10W to 20W crossed out. At step 10W, the wafers were removed from the factory line at Findlay, Ohio, transported to RCA Laboratories at Princeton, N.J., and implanted with boron ions. The wafers were then reinserted in the factory line at step 21W and went through the usual steps for the rest of the processing. Note that the number of wafer-handling steps has been reduced by the elimination of three measurements. Thus, the direct labor cost has been reduced and the possibility of damaging the silicon wafer during handling with tweezers considerably decreased.

The yield improvement of perfect pellets achieved in a large pilot run of 27,683 wafers is shown in Table II, which includes a direct quotation from the factory report on comparative tests. The 13-15% increase in yield and lowered direct labor costs

	Percent yield	
	<i>Ion implanted</i>	<i>Std. diffusion</i>
2.2-volt process	82.6%	67.1%
1.8-volt process	80.7%	67.7%

Table II
Ion implantation vs. standard diffusion. These yield results were obtained after testing 27,683 pellets. Although not all tests were or will be as good as this one, the factory was quite pleased with these results—"The 67-68% yield figure for the standard diffusion controls are considered to be 'very' good for the CD4007 [device]. The consistent 81-82% yields observed in the ion-implanted wafers are rated 'outstandingly' good."

accomplished with the new process is an amazing improvement that can rarely be achieved by modifying a going production line. After this test the factory management ordered an ion implanter for direct insertion into their line.

Many other demonstrations of the use of ion implantation were successful, but generally they were not as dramatic as this one. Also, in certain applications, test runs produced no significant product improvements. Generally, in these cases the factory engineer prefers (and rightly so) to use the equipment that is already installed, paid for, and familiar to the production workers. Tests similar to the one described above were undoubtedly run during this period in many different semiconductor factories. Results were apparently equally positive, because the use of ion implantation in the semiconductor industry began to increase steadily.

Present status

The use of ion implantation in the semiconductor industry is continuing at an accelerated pace. For most processes where exact control of doping concentration is necessary, the use of ion implantation is now routine. The number of ion implanters in use throughout RCA has steadily increased to eleven including the new high-current machines that extend the economical use of ion implantation to many more applications. Probably every major semiconductor manufacturing plant has at least several ion implanters at the present time. Even though much of the fundamental work of applying ion implantation to silicon has been done, research on various details is still necessary to supply data for the refined processing necessary for critical applications. Development work will, of necessity, continue in the semiconductor industry on new circuit applications for years.

The world semiconductor business⁵ has grown from \$3.1 billion in 1972 to about \$6.5 billion in 1977; United States com-

panies have about 60% of this business and Japanese companies have about 25%. At present, competition between Japanese and U.S. companies is intense. The Japanese have launched a large government-sponsored research effort that combines government and industry monetary and technical contributions in an all-out effort to try to establish leadership in the large-scale integrated-circuit field. This type of combined effort, often referred to as Japan, Inc., is difficult to keep ahead of. Fortunately, the semiconductor industry in the U.S. is still vibrant and working very hard. However, it is imperative that new design and new technology, like ion implantation, be pushed hard by everyone in the U.S. to maintain our internal market position, to say nothing of our world position.

Conclusion

The ultimate factory use of such a complex innovation as ion implantation, which requires completely new and expensive machinery, depends upon many factors, as discussed in this article. Fundamental research contributions by many people, stretched over a period of about 25 years, and about five years of testing were required to obtain universal acceptance in the factory environment. Ion implantation's universal acceptance by semiconductor companies all over the world is the ultimate test of its total success as an innovation.

Acknowledgements

Many people at RCA were involved in developing and transferring the ion-implantation technique to the factory. At Princeton, E.C. Douglas, C.P. Wu, F. Kolondra, E. Moonan, and H. Hesser contributed. At Somerville, A.G.F. Dingwall was directly involved, and the factory tests were handled by Findlay personnel.

References

1. For a general discussion of ion implantation, see Dearnaley, G., Freeman, J.H., Nelson, R.S., and Stephen, J.; *Ion Implantation*, North Holland Publishing Co. (1973)
2. For more direct applications, see Pickor, K.A.; "Ion implantation in silicon—physics, processing and microelectronic devices" *Applied Solid State Science*, Vol. 5, pp. 151-249, Academic Press, N.Y. (1975).
3. Ryding, G. and Wittkower, A.B.; "Industrial ion implant machines," *IEEE Trans. on Mfg. Tech.*, Vol. 4 (Sep 1975) pp. 21-31.
4. The RCA Laboratories ion-implantation machine is described in detail in MueBrr, C.W., and Douglas, E.C.; "Ion implantation," *RCA Engineer*, Vol. 18 No. 2 (Aug/Sep 1972).
5. Data by Dataquest, Inc., Menlo Park, Cal., as quoted in the *New York Times* (Jan 18, 1978) p. D1.

Productivity: fighting the cost squeeze

J.S. Race

While the price of almost everything else has gone up, a color tv costs less now than it did ten years ago.

The color television receiver is one of the most complex and familiar consumer electronics products made today. Yet, the performance, quality, and price of this product have improved to the point at which industry sales in the U.S. market were over ten million units in 1978, a record achievement.

The profitability issue has been an important one for U.S. television manufacturers. Although the mid-to-late sixties represented a period of soaring sales and reasonable profits, the picture began to change in the early seventies. Competition for market share among all participants in the business, coupled with continuing cost increases in raw materials, purchased parts, and labor, produced substantial losses for many U.S. manufacturers. Seven eventually withdrew from the television business altogether and some others were taken over by foreign manufacturing firms. Today, such competitors as Philips, Matsushita, Hitachi, and several other overseas-based corporations manufacture television products in the U.S.

To get an idea of the cost pressures facing the television industry, let's examine Fig. 1, which shows how inflation has pushed up the price of materials and wages in the period from 1967 to 1978. During this period of material and labor cost increases, however, the average price of a television receiver has actually declined, as shown in Fig. 2.

Fig. 2 reflects this change in two ways: first, in current dollars, in which the lowest factory price of the average television receiver occurred in 1970; and secondly, in constant 1967 dollars, from which the steady, continual decline in price (or appreciation in value) can be readily discerned. This decline is all the more remarkable since during this same period, such innovations as solid-state

circuitry, superior picture tubes, electronic tuning and controls, and new fire-retardant materials have added significantly to the overall performance/value of the receiver. As a basis for comparison, during the same period, prices for such items as washing machines, clothes dryers, refrigerators, and ranges rose by an average of about 40 percent. The years 1977 and 1978 saw the first price increases in the industry for a number of years: television prices rose approximately 2 percent on two occasions.

Three principal factors helped offset the continuous cost increases previously mentioned:

- increased volume of sales,
- change in the product mix, and
- improved productivity.

The last item, improved productivity, is absolutely key to success, both past and future. In general terms, productivity is defined as the units of product made per hours of manpower. Including such functions as engineering, purchasing, and personnel in the number of hours of manpower gives a productivity figure of merit for a total organization. In general, productivity has been increasing at a significant rate for the television industry, although there was a slight reduction in number of units per man-hour when solid-state sets were introduced. This long-term productivity improvement has more than offset the rising wage/material costs over the past decade and made possible the price reductions previously noted. In rough terms, it can be inferred that the productivity improvement in the television industry is roughly twice that of U.S. industry as a whole.

Three primary approaches have been taken to achieve these productivity improvements:

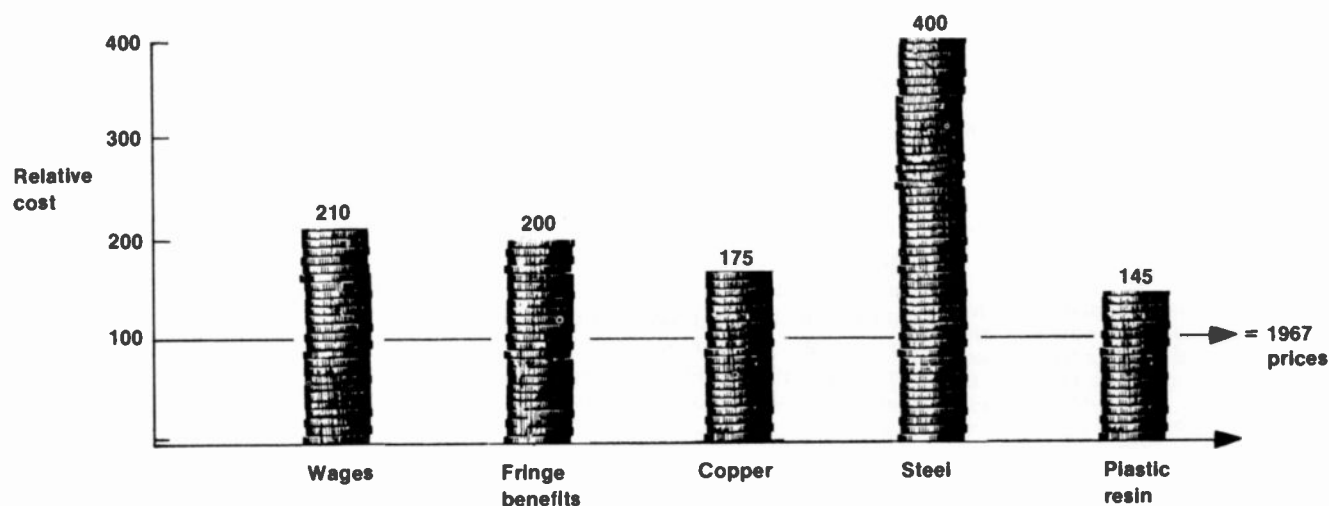

Fig. 1
Price increases for wage and material inputs to tv manufacturing have been substantial; 1967 is taken as base year.

- close control of fixed costs;
- productivity increases by changes in design; and
- productivity increases in manufacturing.

Close control of fixed costs is essential in determining the breakeven point of a business. These costs, whether they be measured in thousands or millions of dollars, must be paid before product sales provide a profit. In years when business is poor and sales volume is down, adequate control of these costs can mean the difference between profit and loss.

The other two items are much more relevant to the scope of this article. Engineers can design in productivity improvements by such means as simplifying circuits, using integrated circuits that combine functions formerly performed by many other components, reducing supporting component count, and improving manufacturability.

The last item in the list above, improved manufacturability, overlaps very strongly with improved productivity from manufacturing programs. Effective communication between manufacturing and engineering is necessary for design improvements that lead to increased manufacturability. Co-design of the product and the manufacturing process is now viewed as essential. To achieve the benefit, for example, of having a printed-circuit board designed for automatic assembly, manufacturing must possess the necessary equipment for auto-assembly and, conversely, if manufacturing has the equipment, the board-mounted components must be designed for insertion on orthogonal axes, etc. Maximum improvements in productivity can only be achieved as a result of effective cooperation between engineering and manufacturing.

Improvements in productivity from manufacturing can be achieved by guidance to engineering, improved methods, and mechanization and automation. Classically, productivity improvements have been a result of improved methods. In recent years, however, enhanced manufacturability via design and automation and mechanization have begun to play an increasingly important role.

The word "quality" has not been mentioned since the first paragraph. Yet the drive toward improved quality and reliability has been just as forceful, just as dramatic as the drive toward lower costs. In a sense, each time improved productivity, improved methods, increased mechanization, or improved manufacturability is the object, improved quality is the result. The driving forces for manufacturing and engineering are reduced costs and improved quality and reliability. They are jointly attainable and inseparable.

RCA has a major commitment to the television business. Nearly 20,000 employees, including over 400 engineers, form the nucleus of RCA's Consumer Electronics television business. Today, as a result of product design, excellence of product performance, and cost-effective approaches to manufacturing, RCA Consumer Electronics has strengthened its position in the television industry and is a substantial contributor to corporate profits.

In the following nine articles on RCA Consumer Electronics television manufacturing, you will gain some insight into both the scope of television manufacturing from raw materials, such as wood and manganese oxides, to sophisticated IC's, to computer-controlled test equipment, to the men and women—operators, supervisors, production-control specialists, quality professionals, engineers, managers, and others—who make the business successful. It is a challenging, rewarding business. Articles in future issues of the *RCA Engineer* will continue to explore the complex world of television manufacturing.

Steve Race, a Manager in the Manufacturing Technology group at CE, works in the area of introducing new manufacturing technology to Consumer Electronics plants. He has worked in a number of roles in CE manufacturing, most recently as Manager, Manufacturing and Resident Engineering, at the Juarez sub-assembly manufacturing plant.

Contact him at:
Manufacturing Technology
Consumer Electronics
Indianapolis, Ind.
Ext. 5636

Reprint 24-4-16|Final manuscript received January 18, 1979.

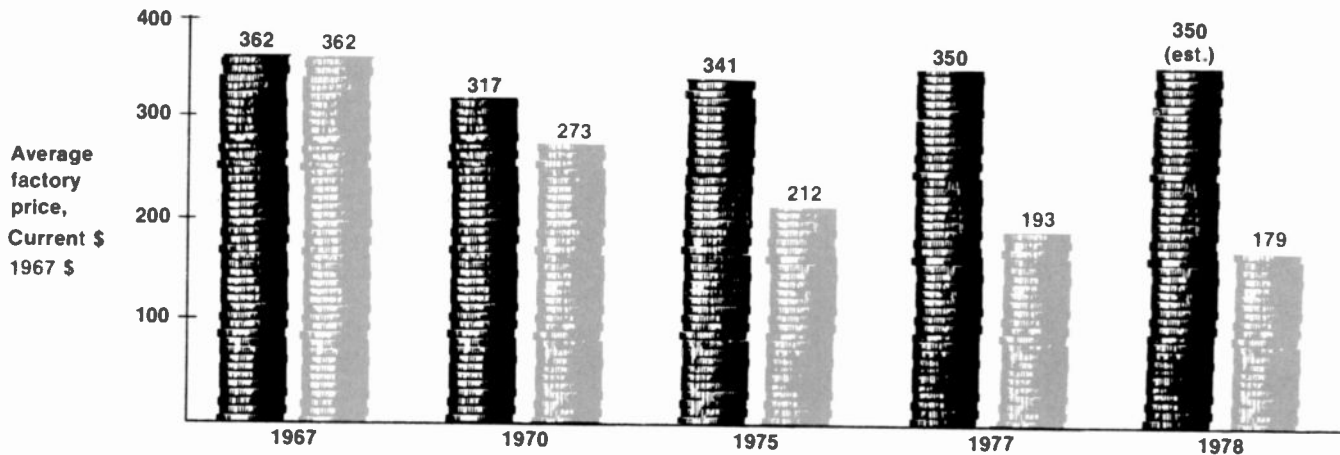

* Using Consumer Price Index as a basis of conversion to 1967 dollars.

Fig. 2

Declining prices for color television sets seem to contradict Fig. 1, but increased volume and increased productivity, together with a change in product mix, have made them possible. Current dollars are shown in black, 1967 dollars are in gray.

Color television final assembly: quality and quantity

G.L. Apple
G.A. Laskaris
R.D. Veit

Simultaneous quality and quantity in manufacturing is a difficult task, but RCA has done it. A lengthy approval cycle and arduous product testing make this high-reliability, high-production operation possible.

Gib Apple is Group Manager of Assembly Process and Tool Design in the Manufacturing Engineering Department. In this position, he directs the development of tooling and layouts, determination of assembly methods, and preparation of assembly processes for color television final assembly.

Contact him at:
Manufacturing Engineering, Consumer Electronics, Bloomington, Ind., Ext. 5382

George Laskaris, Manager of Instrument Quality Control, directs the Quality inspection and testing of color television sets, determines Quality standards of acceptance, and is responsible for the product approval cycles and compliance to all Safety requirements. He has also worked as a Quality Control supervisor, Manager of Purchased Material Inspection and Manager of Material Quality Control prior to his present position.

Contact him at:
Quality Control, Consumer Electronics, Bloomington, Ind., Ext. 5258

Bob Veit joined RCA in 1961 as a production supervisor. Since 1965, he has been a manufacturing superintendent responsible for assembly and test operations in the final television assembly area. This responsibility strongly involves the continuing effort toward better quality and reliability of RCA television sets.

Contact him at:
Manufacturing, Consumer Electronics, Bloomington, Ind., Ext. 5346

Reprint RE-24-4-9
Final manuscript received October 26, 1978.

Authors **George Laskaris, Bob Veit, and Gib Apple** (left to right) and a GC938R color television receiver.



Millions of RCA color television sets are in use throughout the United States and the world. Since the early 1950s, when RCA pioneered color television, many "state of the art" improvements have taken place in circuitry design, performance, and reliability. During this period, manufacturing engineers have kept pace with the design engineers, making many improvements in the assembly and test techniques used to manufacture color television sets. This article discusses these current assembly and test methods.

RCA's color television Final Instrument Assembly Plant (Fig. 1), located in Bloomington, Indiana, employs 500 salaried and 2900 hourly workers. The final-assembly plant at RCA Bloomington, commonly referred to as Plant 2, has 450,000 square feet of space, and is totally devoted to color television final-assembly and materials-support functions. The plant has ten television assembly lines; each line is capable of producing 800 color television sets on a single shift.

Historically, color-television assembly lines have been structured into the following groups for better supervisory and quality control—Cabinet, Tube, Chassis, Final Test, Prepack, Final Acceptance, and Packing.

Production starts at the Cabinet Section. There, cabinets from RCA's cabinet plants or from outside vendors are unpacked and assembled. Over 90% of our cabinets come from RCA's Indianapolis and Monticello Plants. Next, the cabinet goes to the Tube Section, where the picture tube is assembled in the cabinet. The set then goes to the Chassis Section, where the chassis is installed and all connections made. After the set is tested and aligned in the Final Test Section, it is prepared for shipment in

the Prepack Section. The set then goes to a Final Acceptance Section, where electrical performance, cabinet appearance, and customer controls are given a final check before the set goes to the Packing Section. These sections are covered in detail later in the article.

The assembly lines don't start running as soon as a tv set is designed; much preliminary work must take place first. The box on the last page of this article shows all the engineering, quality, and production criteria that must be met before we are ready to produce a specific color television model. As our example, we will discuss the GC938R color television set, which is a "top-of-the-line" set that has a ColorTrak chassis, a frequency-synthesis tuning system, on-screen time and channel display, and an electronic hand unit for remote control.

Cabinet section—6 minutes

The four cabinet types require different assembly techniques.

As previously mentioned, the first section of the line is the Cabinet Section, which is located on the lower level of the building. Workers in this section unpack and start progressive assembly on four different types of cabinets—plastic, mitrefold, knockdown, and conventional.

Plastic cabinets are used for all our small-screen (13" thru 19") models. All plastic cabinets are supplied by our Indianapolis Plant.

Mitrefold cabinets, which are for 25"-screen sets, are delivered to Bloomington as flat, vinyl-clad, presswood panels with precision-cut mitres at the corners. The

cabinets are glued and set up in the Bloomington Plant. This type of cabinet construction saves transportation cost as the flat panels consume considerably less cubic feet than assembled cabinets. Mitrefold cabinets, which are supplied by an outside vendor, are used in the low-and middle-line television styles.

Knockdown cabinets, also a 25"-screen type, are delivered to Bloomington in separate pieces—tops, sides, bases, and front rails—for assembly. All of the cabinet pieces are color-matched by the supplier before shipment. Again, this type of cabinet offers considerable transportation savings as five complete cabinets can be packed in one normal-size, reusable color-television carton. More than 90% of our knockdown cabinets are supplied by our Monticello Plant. These cabinets are the most popular 25"-cabinet style and can be



Fig. 1
RCA's color television final assembly plant at Bloomington, Indiana. Plant 2, where most of the assembly takes place, is the right background. Plant 1 is in the foreground, and the Distribution Center is in the left background. Conveyors connect the different plants.



Fig. 2
Testing and inspection of components is an important preparatory step. The machine on the left is a high-speed diode electrical sorter; the one on the right is a high-speed computerized transistor sorter.



Fig. 3
Typical Cabinet Section assembly line. Knockdown cabinets are being assembled here.



Fig. 4
End of the cabinet assembly line. The automatic elevator at the left takes the cabinets and cartons (on separate levels) up to the main floor for the rest of the assembly operations.

found throughout the complete product line.

Conventional cabinets are those 25"-screen cabinets, at the top of the product line, that arrive in Bloomington completely assembled. The Monticello Plant, in addition to other vendors, supplies this cabinet type. Our sample television, the GC938R, uses a conventional cabinet supplied by RCA's Monticello plant.

The GC938R cabinets are delivered to the Cabinet Section assembly area by battery-powered grab trucks. At this point, the cabinet is unpacked and placed on the powered belt assembly line and its carton is placed on an overhead belt conveyor for a 500-foot ride to the Packing Section and ultimate reuse (Fig. 3). As the cabinet moves down the assembly line, the plastic cabinet front, speakers, chassis-mounting hardware, trim overlays, and control-area door are installed. These and other associated tasks are accomplished with common tools and pneumatic screwdrivers. All of the production operators are responsible for workmanship quality inspections; however, at the end of the Cabinet Section, a thorough workmanship

and cabinet appearance inspection is repeated. Cabinets not meeting quality standards are corrected before the cabinet is allowed to leave the section. When the cabinet is ready for delivery to the next section, it is placed into an automatic two-level elevator that delivers it to the main factory floor at the appropriate time. (The upper level of the elevator carries the carton, which has now been reunited with its cabinet.) From unpacking to the elevator, six minutes have elapsed (Fig. 4).

Picture-tube section— 6 minutes

The tube and its cabinet are "married" here.

The Picture-tube section is the first assembly section on the main floor. There, the cabinet is automatically unloaded from the elevator and rolls down to the assembly-line starting position. The assembly line, which extends through all of the main floor sections, is a 410-foot slat conveyor with isolated power outlets in the slats to facilitate electrical testing.

Before discussing the Picture Tube section, we should discuss the tube itself. Picture

tubes are received, unpacked, and loaded on a monorail in the Plant 2 lower level for delivery to each television assembly line. Tubes are placed on the monorail prior to starting assembly of the cabinet that will receive a particular tube, since the travel time on the monorail to the point of use is 30 minutes (Fig. 5).

As we start the Tube Section assembly work, the GC938R cabinet is placed on the assembly line and preparations begin immediately to mount the picture tube into the cabinet (Fig. 6). In addition to the picture tube, other major components, such as the automatic degaussing shield and coil assembly, deflection yoke, convergence assembly, and magnetic beam-correction device, are assembled to the cabinet. To control critical assembly and handling requirements, special tooling was developed in Bloomington. The deflection yoke is held on the picture-tube bell with four pieces of double adhesive foam tape. The yoke is accurately positioned and seated with 120 lb of force with a semi-automatic press (Fig. 7). After the yoke is properly positioned and adhered to the picture tube, the tube automatically advances to the next position, where the

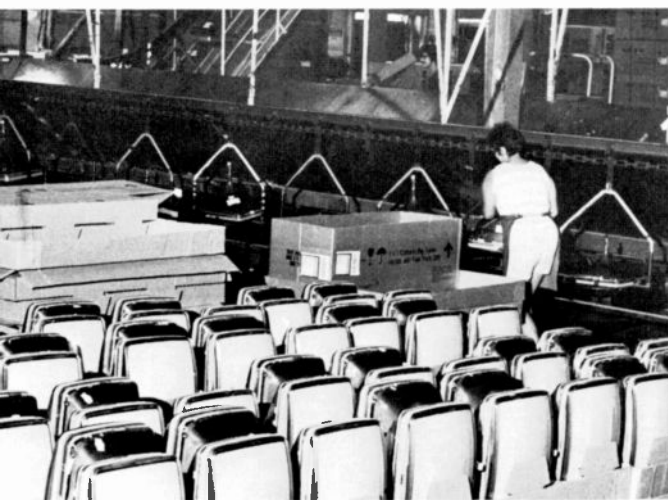

Fig. 5 (left) **Picture-tube unloading area.** The operator is placing a 25-inch tube onto the color-coded monorail conveyor that takes it to the appropriate assembly line.



Fig. 6 (center) **Picture-tube section.** The vacuum unloader at the left is used to place the tube into the cabinet.



Fig. 7 (right) **Yoke-assembly press.** The yoke is being assembled to the tube at the left. Extremely critical assembly controls are necessary to avoid picture-tube neck damage during yoke positioning and to make sure that the yoke adheres to the picture-tube bell properly.



Fig. 8 (below) **Operator using vacuum handling fixture** to make final adjustment of a 25-inch picture tube in its cabinet.

mounting brackets and retaining band are positioned and assembled by a production operator.

The tube is now ready for positioning in the cabinet. However, since the tube weighs 65 pounds and has no hand holds, a special vacuum fixture is attached to its bell at four places. The tube is lifted with an air balancer, moved to the cabinet, and lowered into position. This vacuum lifting fixture was designed "fail-safe" to keep a tube from being dropped even if there is an air loss or inadvertent vacuum blow-off by the operator (Fig. 8). Other tools used in this section are more common and are mainly comprised of pneumatic screwdrivers, torque-controlled pneumatic screwdrivers, and hand torque tools.

As with the Cabinet Section, all production operators are responsible for workmanship inspections and special checks are made at the end of the section to ensure that the assembly and positioning of the picture tube meet specific quality criteria. Units not meeting quality standards are corrected before moving to the next section. From the elevator to the end of this section, six minutes more have passed.

Chassis section—6 minutes

In this section, the chassis is mounted, cabling connected, and the set is operated for the first time.

The next section on the assembly line is the Chassis Section. As with the picture tube, the chassis is delivered to the line on a monorail. The chassis is placed on the delivery monorail 33 minutes before the cabinet for that chassis is started. As chassis arrive at the assembly line, they are removed from the delivery monorail and prepared for assembly to the cabinet (Fig. 9). When the GC938R cabinet arrives from the Tube Section, the chassis is immediately installed (Fig. 10). As the cabinet progresses through the Chassis Section, the frequency-synthesis tuning system, remote amplifier, and remote pre-amplifier are assembled to the cabinet. Also, all cable connections are completed to marry the previously assembled components into a working television set. Near the end of the section, the television set is turned on for the first time, extensively inspected, and given initial quality checks to verify that it is acceptable to proceed to the Final Test Section. Another six minutes have elapsed in the Chassis Section. At this point, 18

minutes have elapsed and almost all of the 1000 pieces of raw material and sub-assemblies have been brought together to create a GC938R color television set.

Final test—17 minutes

This section does the final inspection, alignment, and circuit testing in the television set, adjusts it for customer viewing, and checks all safety-related circuits.

The television set now moves into the Final Test Section. Although the set has been under power for less than three minutes when final testing begins, the major electronic components have been subjected to testing and alignment in the "sub-assembly" stage. The chassis and remote amplifier, supplied by RCA Juarez, have been aligned and tested using automatic test equipment. The frequency-synthesis tuner, supplied by RCA Taiwan, has been tested using manual test equipment. The convergence assembly, remote pre-amplifier, remote transmitter, and the frequency-synthesis controller are assembled and tested in Bloomington using both automated and manual test equipment. All of the above tests are circuit and functionally oriented, simulating the con-



Fig. 9 (top left) **Chassis being taken** from the overhead monorail at left and being prepared for assembly to cabinets at right.

Fig. 10 (center) **Chassis section.** The wooden-slat conveyor is moving from front to rear. The operator partially out of the foreground is obtaining a chassis to install in the next cabinet.

Fig. 11 (bottom left) **Final-test operator** using optical sensor and light box to align color temperatures properly.

Fig. 12 (right) **Quality control inspectors** making a customer-type review in the Quality Acceptance section. Inspector with the rubber ball mallet is making a "flash when tapped" check to verify picture stability under adverse conditions.

ditions these components will face in a final television assembly.

Alignments and circuit checks are done with test equipment and by observations of picture and sound quality. These checks are made using customer and service set-up controls. During the course of these checks, signal-strength levels are varied to ensure proper operation of the set regardless of its final location, whether it be a rural area or close to transmitting stations.

To provide constant, repeatable color alignments and component measurements, a number of test aids were developed in Bloomington. These aids enable us to judge critical adjustments objectively rather than subjectively (Fig. 11). All of the alignments and measurements in Final Test are accomplished in 17 minutes.

Prepack—4 minutes

Here, the set receives its serial number, final assembly work, appearance checks, and safety inspections.

After the set has been accepted in Final Test, it progresses to the Prepack Section. In this section, all television sets are given serial numbers to enable tracking of the set to the distributor, dealer, or customer and to provide a method for internal production and warehousing controls.

The serial number is printed by special printing equipment in the Bloomington plant. Its nine digits contain the following coded information: year of manufacture, week of manufacture, day of the week, line number, place of manufacture, and three sequential arbitrary numbers. The serial ticket also contains the instrument model number and cabinet color or finish.

As the GC938R moves through Prepack, final assembly work and final mechanical, cabinet appearance, and safety inspections occur. The assembly work consists of permanently affixing a section of serial ticket to the chassis, installing the back cover and putting together a literature package for the customer's use. The safety inspections are critically controlled to ensure that each television set meets all applicable safety regulations specified by H.E.W., U.L., and C.S.A. at the time of manufacture. This work is completed immediately prior to assembly of the back cover so that safety-related items are not accidentally disturbed by other production operations. Specially trained cabinet-finish personnel inspect overall cabinet appearance. Four minutes after entering the Prepack Section, the television set enters the next to last section of the line, Acceptance Test.



Fig. 13 (top left)
Shock hazard test on a typical 25-inch set.



Fig. 14 (bottom left)
Into the carton. Vacuum handling equipment is necessary, since the completed television may weigh over 250 pounds.

Fig. 15 (top right)
Drop testing, which simulates shipping conditions, is done to check that packing protects set properly against abnormal handling.

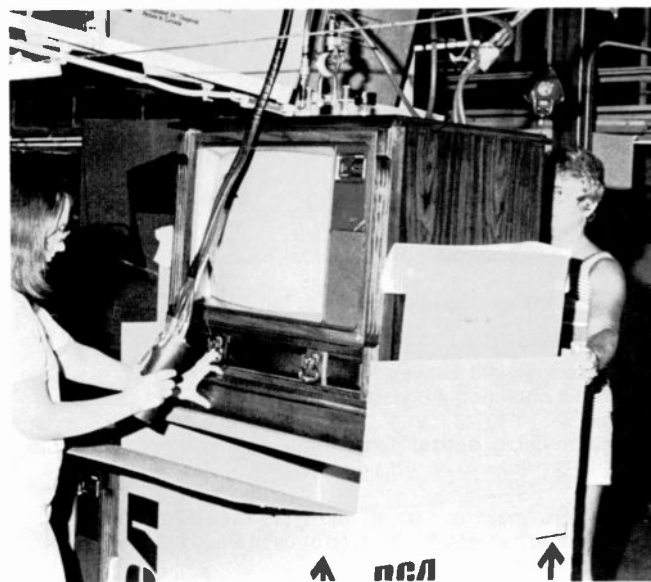

Fig. 16 (bottom right)
Consumer Acceptance Analyst making the initial quality check on randomly selected 19-inch sets.



Acceptance test

After all assembly, alignment, testing, and inspection of the television set have been completed by Manufacturing, the set must pass the on-line final Quality Acceptance Test.

This test is performed on every television set built in the Bloomington Plant by Quality Control Inspectors stationed at the end of the instrument line just prior to the Packing Section. This test is a customer-type review of the general performance of the set; it checks VHF channels (2 thru 13) and UHF channels (14 thru 83) using factory-produced test patterns. All of the customer controls are checked for proper operation and left in a pre-set position, followed by a general check of the overall appearance of the set (Fig. 12).

The accepted sets then proceed into the Packing Section. Sets not acceptable in this check are identified and removed from the line for correction. After sets removed from the line are corrected, they are routed through Final Test, Prepack, and Quality Acceptance a second time.

Working in conjunction with Acceptance Test, another team of Quality personnel assigned to each assembly line makes "over-the-shoulder" audits of all assembly and test operations. There is very close scrutiny of the H.E.W., U.L., high-voltage, hi-pot, and safety assemblies and inspections.

Packing—4 minutes

The shock-hazard test is the last event before the set goes into its carton.

The last section of the assembly line is the Packing Section. Prior to actual packing, the serial ticket section, stamped by the Quality Control Inspector in Acceptance Test, is permanently adhered to the back cover. Also, each set is given a customer shock hazard test—all metallized surfaces that are accessible to the customer (whether located on the front, the back, or underneath the television set) are checked with 1080-V ac and 500-V dc "hi-pot" equipment to verify that absolutely no possibility of a shock hazard exists on the television set. The hi-pot equipment is equipped with visual and audio alarm circuits to doubly ensure that faults are noticed (Fig. 13).

After the hi-pot operation is completed, the television set is ready for packing. The carton that was put on the overhead carton conveyor 40 minutes ago arrives to again accept a cabinet that now contains a ready-for-sale television set. Since the set weighs more than 250 pounds at this point, it was necessary to develop special vacuum equipment for loading it into the carton. A vacuum head is placed in the center of the cabinet top, and the cabinet is raised and lowered into the carton (Fig. 14). After the cabinet is placed in the carton, the top protective packing is positioned and the carton containing the finished GC938R television set is sealed.

A random number of television sets are removed daily from the Packing Section for further auditing by Quality Control. This audit includes a complete packing check, simulated shipping tests (Fig. 15), and an extensive operational check of the television set using both factory-supplied signals and air signals from cable TV.

Consumer Acceptance Lab

At the end of the Packing Section, an automatic "lowerator" takes the carton to a powered roller conveyor system that delivers the television set to the Distribution Center, an adjacent building. The completed television sets are stored in the Distribution Center until they are released for shipment by the Consumer Acceptance Lab (CAL). This group is independent of the plant and reports directly to Division Quality Assurance.

CAL samples approximately 5% of the product from warehouse stock, or more than 100,000 sets annually, with each production line's product being sampled daily.

This sampling indicates the actual quality of the product leaving the plant for the consumer market. Decisions for either shipping or retesting the product are made on the basis of the sample results for each line. The sampling/testing is conducted in three phases:

Initial quality. Each set in the sample is subjected to customer-oriented evaluation per predetermined checklists of inspections and tests (Fig. 16). About half of the sample is subjected to simulated shipping tests while the other half of the sample is tumbled to simulate handling. Shake and drop tests are designed to simulate shipping conditions. The shake tests take place on vibrator tables operated at a one-g force for one continuous hour. The drop-test height varies according to the weight of the packed television set, but each set is dropped on all four sides and the bottom. In addition, one set is placed in a freezer at 0°F for 24 hours. After the shake, drop, and freezer tests are completed, the television set must be completely operational and have no damage as removed from the carton.

Short-term life test. Samples of each day's production are selected from the initial quality group and operated for 12 hours with elevated line voltage in an

Fig. 17
Long-term life testing. There are always 1000 sets undergoing this performance evaluation at elevated line voltage and ambient temperature.



elevated ambient temperature environment.

Long-term life test. Additional samples of the product are placed on a 500-hour life test operated under conditions similar to the short-term life test (Fig. 17).

Performance results from CAL testing are analyzed daily, weekly, and monthly to detect any failure patterns or to make

recommendations for needed design changes or for corrective action by the plant.

The acceptable quality level at CAL has been improved each year—the 1978 level is three times better than the 1975 level. The amount of drop and shake testing being performed daily by both the CAL and Quality Control functions has increased over 1000% since 1975.

Conclusion

We believe the GC938R color television set that passes all of our assembly, test, quality, and CAL audits is not only the top of our line but "The Top of the Line" in color television receivers. Pride in our performance and our product's performance has made RCA the number one name in color television and Bloomington the "Color Television Capital of the World." We intend to keep it that way!

Before the first production set is built

Prior to the start of television production, a sample of all tv sets and the raw material used in them must undergo special tests and factory reviews to ensure they meet all product requirements and criteria. These checks are referred to as product and material approval cycles.

The first step of the TV product-approval cycle is the Pilot Run build, where a small number of new television models are built in the factory for the first time.

This is done to check the form, fit, and function of the various parts and to identify needed corrections to the tooling, design, parts specifications, and parts quality. Also, the Pilot Run checks Manufacturing test methods and procedures, assembly processes, and the overall manufacturability of the television set.

The completed television sets from the Pilot Run are subjected to shake and drop tests that simulate shipping conditions, and then receive 1000 hours of cycled life testing at a room temperature of 80° F and at a 130-V AC line voltage. These stress conditions check product performance and parts reliability to ensure that the set will operate successfully in abnormal environments.

After the Pilot Run testing, the results are evaluated, any needed corrections are made to design and manufacturing inputs, and a Pre-production build is scheduled.

Television sets in this run are built only of approved parts, using finalized test and assembly tooling and processes. This Pre-production run verifies that the corrective actions were effective. At this time, all of the final approvals needed before the instrument may be produced in volume are obtained. The final approvals consist of:

Quality Control and Design Engineering approval that the product adheres to the instrument specifications; an Appearance Committee approval; a Safety Committee approval certifying that the tv set passes all of the Underwriters Laboratory (U.L.), Department of Health, Education and Welfare (H.E.W.), Canadian Safety Authority (C.S.A.), and RCA safety requirements.

A concurrent material approval cycle covers each of the 1000 different parts used in a typical RCA color TV set.

RCA receives these parts from over 500 different suppliers in 42 states and 15 foreign countries. All new parts and/or new vendors must undergo very stringent initial inspection or testing of all parameters, dimensions, and specifications on RCA drawings and must receive proper approvals before the material is deemed acceptable for use in production.

An "E-Form" approval is issued by Design Engineering as evidence that the part is as it was designed to be. An "M-Form" approval is given by the receiving manufacturing facility on parts that are produced on the supplier's finalized tooling. An "A-Form" approval is required on all appearance-type parts, such as cabinets, knobs, and overlays; this approval is given by Industrial Design Engineering. After all of the proper approvals have been received, Purchasing can instruct the supplier to produce and ship parts in production volume.

The various parts fall into electrical, mechanical, plastic, and electromechanical categories. As such, they receive many different types of inspections and tests after they are received. The Purchased Material Inspection group performs these inspections. This group, which is equipped with highly sophisticated electronic and mechanical measuring equipment, bases its check-lists of test and inspections on past history, job experience, information listed on drawings, and Engineering and Plant Quality Control instructions (Fig. 2).

When the parts shipment is received, samples for inspection are pulled at random, with quantities determined per sampling plans. If the sample taken indicates that the incoming parts are not acceptable, the shipment is returned to the supplier or the shipment may be sorted or reworked at the Bloomington Plant.

Full production on a new model television begins only after all these steps are taken. Experience has shown this lengthy procedure to be absolutely necessary to produce a quality product.

Automated system increases quality and production of printed-circuit boards

There's much more to it than print, etch, and punch. RCA is investing \$1.5 million to automate its production of printed-circuit boards.

J.R. Arvin

A typical color television set may contain from four to ten printed-circuit boards, depending upon the sizes of boards used. Since RCA produces thousands of tv sets per day, printed-circuit-board production must be very high—over 20,000 square feet per day, or over 4 million square feet per year.

Automating and updating

This effort requires a highly efficient plant. Consumer Electronics in In-

dianapolis, where essentially all of RCA's printed-circuit boards are made, has one of the largest (over 40,000 square feet of production space) and most modern facilities for making single-sided boards in the United States. (RCA presently makes only single-sided boards at Indianapolis.) To keep this operation as efficient as possible, RCA has invested more than \$1,500,000 in updating and automating it since December 1976; the work should be complete in March 1979.

Automation here is not a simple process of purchasing faster and more automatic machinery—some processes have had to undergo basic changes. For example, the solvent-based inks, which were formerly used, cured too slowly for automatic equipment, so they had to be replaced with fast-curing solid-based ultraviolet inks. The results of this changeover have been excellent. Although we knew that the new ultraviolet inks would cure three times faster than the solvent-based

Making PC boards, step by step

First, some preliminary steps must take place.

Making the artwork. Inputs for the board layout go into a computer-aided design system that draws 1:1 photomasters directly. The number of boards per panel has varied from one to 375 (panel sizes range from 18¼ x 11 inches to 18¼ x 24 inches).

Making the screen. Each printing operation requires its own screen, which is made from 305-thread-per-inch polyester. Screens do not last forever, so the number made depends upon the size of the production run. Screens are needed for printing the following images: the copper circuit, the solder resist, the topside (or component side) circuit pattern image, topside nomenclature (or roadmap), and the bottomside roadmap.

1 Pilot-hole punching. This is the first step in the actual production of the board. This large punch press pierces all the holes that locate screening and tooling throughout the remainder of the manufacturing process.

The automatic printing-etching line. This continuous line (photos 2-4) is the major part of CE's automation/modernization program. An automatic feeder sends the panels through a "preclean" line, where the panels are mechanically abraded, water-rinsed, and blown dry with hot air. A con-



veyor then transfers the panels into a clean room, where the screening is done. (Printing in this clean room, rather than out in the midst of the factory floor, has been one factor in improving the quality of printed-circuit boards at Indianapolis.)

2 Automatic screening. This operation prints the ultraviolet-curing etch-resistant



ink on the copper side of the panel. The boards shown here are being printed twelve to a panel. Inspectors check the printed panels as they move along the conveyor, which leads out of the clean room to an ultraviolet-light unit that cures the ink rapidly. (The three-fold speedup in curing time achieved by switching to ultraviolet-curing inks is the major reason for increased production through this line.)

inks, they also gave us an unexpected benefit—the reject rate dropped because the inks are easier to screen.

The modernization program is now fairly complete and its benefits are already evident. When the program is completed in March 1979, when the last automatic screen printing line will be installed, we should see the following accomplishments:

- 1) the labor needed to screen and inspect printed-circuit boards will decrease by 50%;
- 2) the screening rates will double;
- 3) the quality of the boards will be improved greatly; and
- 4) the energy required to produce the boards will be reduced.

What's involved?

A printed-circuit board has two main functions—providing an electrical con-

nection between components and providing mechanical support for those components. This can be done with a number of board types—single-sided, double-sided, double-sided with plated-through holes, and multilayer boards (both rigid and flexible). RCA's Indianapolis plant, however, only produces single-sided boards because of their reliability advantages. A not-so-obvious function of the board is to assist service personnel by identifying components, test points, etc., with screen-printed "roadmaps" on both sides of the board.

Manufacturing printed-circuit boards begins with the material, which is a plastic-copper laminate. The copper foil is typically 0.001 to 0.0014 inch thick, and the base material is usually one of the following: FR2, a 1/16-inch-thick paper-base phenolic; FR4, a 1/32-inch-thick epoxy/glass material; and a

1/16-inch-thick composite made of epoxy and paper-base phenolic.

Taking this material and turning it into a printed-circuit board involves about twenty manufacturing and inspection steps, which are explained by the photos and captions accompanying this article. Simplified to bare bones, however, the process consists of screen printing the desired pattern on the copper side of the laminate with etch-resistant ink, etching the unwanted copper away, and punching out the holes and board outline.

The automated equipment now being installed at Indianapolis has helped increase production, as already noted. It is also helping improve the quality of the boards, to the point that the plant's goal is now to ship all boards to assembly plants at an acceptable quality level (AQL) of 0.1%.

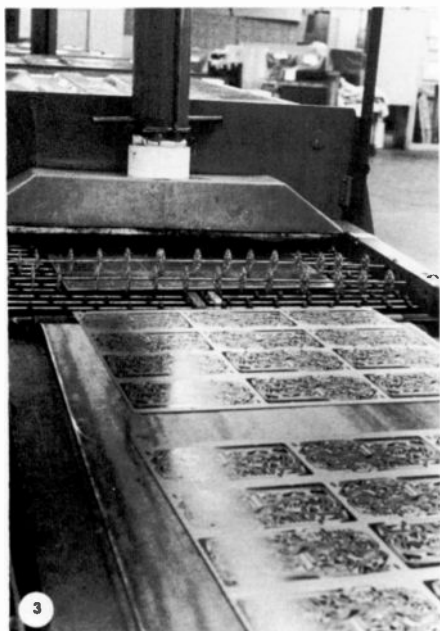

3 Five-stage etching system. "Chemcut" etcher removes un-inked copper from the panels as they move through the system at 18 feet per minute. Panels on line here are moving into the first stage of the etcher; note that the dark inks are still visible. Since the ink is not needed after etching, it is removed by a caustic solution. Panel then is water-rinsed, abraded, and rinsed again.

4 Stacking and inspection. At the end of the etch line, panels are automatically stacked.



Inspector is making one of many visual checks along the automatic line.

5 Automatic testing. Each panel is 100% electrically tested for copper opens and shorts. The automatic tester shown here stepped through the 1888 tests needed for this board in about 8 seconds; it is capable of 2400 tests. The inspector also visually checks boards at this point for potential opens and any obvious defects.



6 Miscellaneous screen printing. Every panel may require a different combination of miscellaneous screening operations, but the average panel requires four—solder resist, topside and bottomside nomenclature (roadmaps), and the topside circuit pattern image. This photo shows a panel that has just been deposited on the printer conveyor by a vacuum lift. The equipment used for these screening operations is fully automatic—the only completely automatic screen printers in the U.S. (RCA had to

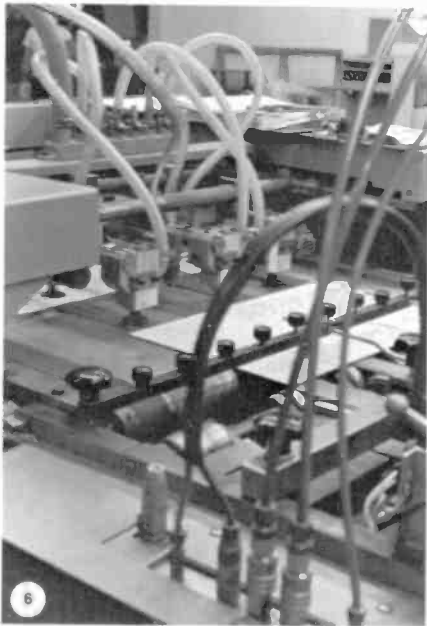

purchase the printers in Europe because no American manufacturer offered any.) The four lines each consist of a feeder, screen printer, panel reverser, and stacker, all automatic. Only one inspector is needed for two lines. The curing time of the ultraviolet inks is the limiting time on these lines, which operate at 35 feet per minute.

7 Protective coating. To preserve the solderability of the copper for as long as six to twelve months, a "Sealbrite" protective coating is applied by a large conveyORIZED dip-coating machine. Racks of panels move through the machine as the panels are chemically cleaned, rinsed, coated, and cured. Interestingly, the vats move up to the racks, rather than the other way around, to maintain the integrity of the overhead trolley system.

8 Final piercing and blanking. A 65- to 125-ton punch press punches all the holes on the boards and blanks out the outlines of the individual boards on the panels. Some laminates require warming before punching, to avoid cracking. The operator here is shaking the individual boards loose after punching.

9 Final inspection. The boards undergo a final 100% visual inspection to an 0.1% acceptable quality limit (i.e., 99.9% of the boards reaching the assembly plant must be good).

10 Ready for shipping. These convergence boards will go on the deflection yoke of a color tv set. They are stacked here awaiting shrink wrapping to protect them until they are ready for use.

Jim Arvin joined Consumer Electronics in 1964 as a Manufacturing Methods Engineer, and was promoted to Process Engineering Manager in 1966. He was responsible for the printed circuit board area until recently, when he was transferred to plastics molding and finishing.

Contact him at:
Manufacturing Engineering
Consumer Electronics
Indianapolis, Ind.
Ext. 5614

Reprint RE-24-4-1
 Final manuscript received August 10, 1978.

Components to boards to chassis: subassembly manufacturing for color tv

H. Barrio

Each day, RCA's Juarez plant turns seven million components into six thousand color tv chassis.

Manufacturing televisions is a very large and complex operation; so large that it is impractical to manufacture the entire set at one location. Accordingly, RCA has established "feeder" plants that supply sub-assemblies of the final television instruments. Juarez, Mexico, is the location of such a feeder plant; it supplies very large quantities of circuit boards and chassis for the final assembly plant at Bloomington, Ind.

This article shows how the Juarez plant produces 6000 tv chassis each working day.

Hector Barrio, deflection module assembly line, and automatic testing equipment.

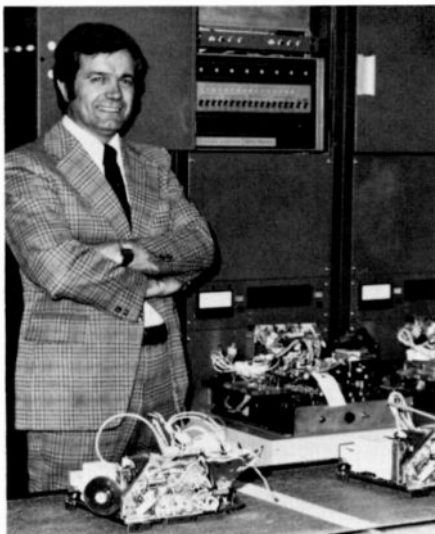

Hector Barrio joined RCA Juarez in April 1969 as a process engineer and rapidly advanced to Manager, Process Engineering (April 1970); Manager, Manufacturing and Plant Engineering (December 1970); Manager, Manufacturing Engineering (September 1972) and Manager, Manufacturing (April 1974).

Contact him at:

**Manufacturing
Consumer Electronics
Juarez, Chihuahua, Mexico**

Specifically, it shows:

what is done to assure that only acceptable parts find their way into the assembly line;

how circuit boards are assembled and tested;

how modules and chassis are manufactured;

and finally, how the final products go through exhaustive performance and environmental testing prior to delivery to the color television receiver assembly plant in Bloomington.

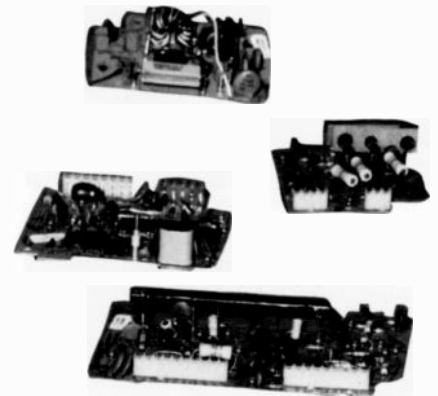

Fig. 1
Each chassis contains approximately ten circuit board modules; these four are typical. Components on the boards range from large discrete capacitors and resistors to integrated circuits.

The challenges of ever increasing quality and decreasing cost create a demanding environment for the manufacturing engineer, who must keep right up with the state of the art to meet the challenge.

What makes up a chassis?

A typical color tv chassis, the CTC-92, has ten printed circuit boards—the kine driver, screen control, sound, vertical, horizontal, chroma, regulator, pix IF, luminance/sync, and interconnect boards. The first nine are modular, interchangeable boards; the last is a mother board that interconnects the others and provides a base for most of them. Four of these boards are shown in Fig. 1.

This chassis also has three wire-trap boards. They consist of a perforated piece of phenolic material holding several wire-traps, where components and lead wires are manually inserted and then soldered.

There are three other boards in a CTC-92 scan remote instrument: the tuner, tuner control, and digital memory. The tuner manufacturing process is somewhat different from the one used for the rest of the boards, but the other two boards are produced by a process that is basically the same as the one for the chassis boards.

Checking incoming quality

The first step in any manufacturing process must be the inspection of the raw material. Incoming quality is particularly important in manufacturing tv chassis because of the massive number of chassis produced (6000/day) and the large number of components used (1200/chassis), requiring around 7.2 million parts daily.

The Material Quality group inspects materials ranging from acetone to Zener diodes, making tests that range from simple ones for screws to the more complicated testing of integrated circuits (Fig. 2). The inspection is performed on a random-sample basis per MIL-STD-105D. This sampling procedure assures that a lot being received contains no more than a predetermined percentage of defective parts, or acceptable quality level (AQL). Currently, the AQLs used to inspect incoming material range from 0.1% to 0.65%, depending on the commodity; solid-state

devices, for example, are sampled to an 0.1% AQL, while capacitors are sampled to 0.25%. These levels of inspection are predetermined by CE's Division Quality Group.

Board assembly

The first step in making circuit boards is the automatic insertion of components.

At the current time, the only components being automatically inserted into the printed circuit boards are resistors, disc capacitors, diodes, bus wires, and some stakes. These components account for 51% of the total number of parts in the boards. Two types of automatic-insertion equipment are presently being used in the Juarez plant: In-line and Variable Center Distance (VCD).

The In-line equipment (Fig. 3) is an old concept being displaced by the VCD type. It consists basically of a number of individual heads (40-50) placed on a fixed frame and a belt conveyor that synchronously transports the boards from station to station using mechanical locks and micro-switches on each station. Although the production rate on this type of equipment is quite high (1075 boards per hour) it has several disadvantages:

- it requires an elaborate set-up each time there is a model change;

- it requires a large number of pallets for each board; and

- it can insert only up to 50 components on each board.

The Variable Center Distance equipment (Fig. 4) is much more flexible. It has two stationary heads, two x-y tables for inserting two boards simultaneously, and a computer that controls the distance between centers of the component to be inserted, adjusting the inserting and clinching mechanism for each component. The rate for this machine varies with the number of components inserted; for example, 50-component boards can be inserted at about 200 boards per hour.

Before inserting the components in the VCD equipment, they must go through the sequencer (Fig. 5), another piece of computer-driven equipment that cuts the components from their original reels and then reels them again in the predetermined sequence in which they will be inserted. This sequence is checked in a sequence verifier. If a part is missing from the



CE's Juarez plant—background

Established in 1968 as a feeder plant supplying components, subassemblies and assemblies, Consumer Electronics' Juarez plant moved to its present location in 1969. The size of the operation has doubled in the last two years and now covers over 300,000 square feet.

Close to 6000 people work at the plant, making it the largest employer in Juarez. About 200 of the employees have engineering degrees. The plant is staffed by Mexican nationals except for a staff of less than a dozen U.S. citizens.

Hector Barrio's article describes the flow of some typical products through this fast-paced facility.



Fig. 2
Incoming material is inspected automatically whenever possible. Instrument shown is a transistor tester.



Fig. 3
Automatic insertion, the old way. The in-line equipment shown here is quite fast. However, because each station puts only one component in one specific location, changeovers to different boards are time-consuming.

inserting sequence, this machine stops and its operator manually adds the missing part before re-starting the machine.

The set-up in the VCD equipment is quite simple, requiring only a change of the board-holding plate, recalling the appropriate program from the computer memory, and replacing the reel of components. For a two-head machine, this may take an operator 10 minutes, while a 50-station changeover on the in-line equipment may take two set-up men four hours.

Not only does the automatic insertion equipment save labor, it also reduces the possibility of operator-induced errors such as mixed or missing parts. The repeatability of the process yields parts that are cut and clinched uniformly and, as the need for lead cutting after soldering is eliminated, eventually gives more reliable solder joints.

The remaining half of the components must be assembled manually.

Manual board assembly takes place using an in-line conveyor (Fig. 6). There, the operator takes the components out of bins and inserts them on the boards. When insertion is complete, the operator pushes a button and the boards move on to the next station. Special precautions are taken on the lines where modules containing integrated circuits are being produced. Operators and equipment are grounded at all times to prevent static electricity discharges from damaging the ICs.

After all the components have been assembled, the boards get soldered.

At the solder station, the boards first go over the fluxer, where a thin film of mildly activated rosin flux is applied to the bottom of the boards. Then, an infrared lamp preheats the boards and increases the activity of the flux before the boards go into a solder bath for 3-6 seconds. The leads of those components not automatically inserted are then manually clipped when required. After clipping, they go through a second flux-solder system and finally over a rotary-brush cleaner that removes any excess flux from the bottom of the board.

Individual boards are inspected manually and with automatic equipment.

The boards then go through the Manufacturing inspection, where a visual check makes sure there are no missing parts, bad soldered joints, or violations of the critical



Fig. 4
Automatic insertion, the new way. This variable-center equipment puts all the components onto a board from a sequentially set up feeder tape. Although this computer-driven equipment is not as fast as the older equipment, it is much more flexible.



Fig. 5
Sequencer puts components onto reels in the proper sequence for the variable-center insertion equipment shown in Fig. 4. Also computer-driven, this machine cuts the components from their original reels and reels them again in the proper sequence.



Fig. 6
In-line conveyor brings components to operator for manual insertion on boards that move along conveyor in foreground. Ground strap on operator's right arm protects ICs from static discharges.

lead-dress specifications. Any defects found are repaired and the board is sent to the test area at the end of the line by means of a belt conveyor.

The boards are tested electrically using Automatic Test Equipment, or ATE, (Fig. 7). The test is very fast, and if the board is rejected in one or more of the test parameters, a printout indicates the tests

failed. (For a complete description of ATE, see the article by Ben Borman in this issue.) Failed boards are sent for troubleshooting and repair, then returned to test before they are presented to the Quality Control inspector for approval.

At the end of each line there is a Quality Control Station. The boards are accumulated into lots and a sample is taken



Fig. 7
Automatic test equipment checks out finished circuit boards very rapidly. Testers can test two boards independently. Display at top of cabinet gives commands to operators.

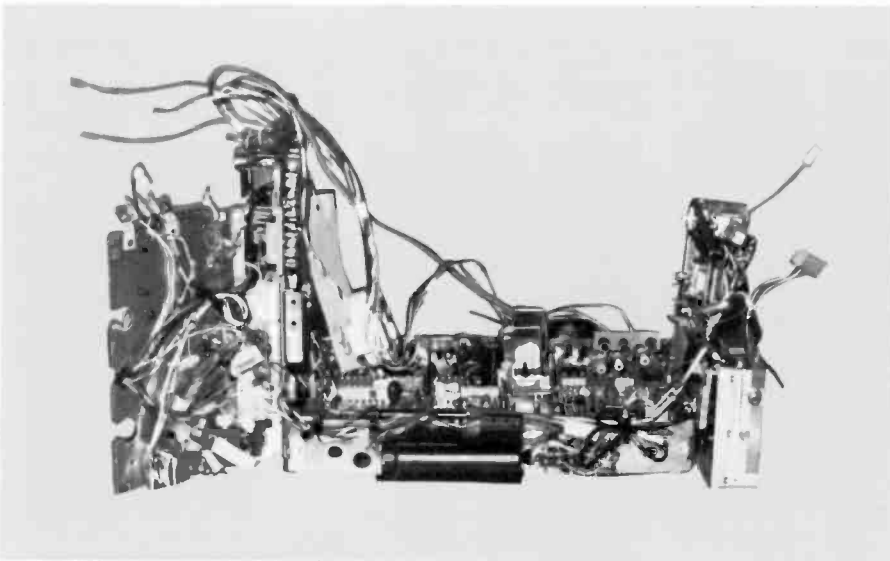

Fig. 8
Finished chassis consists of three modules—deflection, signal, and power.

by the Quality inspector to an AQL of 0.4%. The sample is inspected for compliance to the Engineering drawing, specifications, and any workmanship criteria that may be determined by CE's Quality group.

The inspection consists of:

- verifying that the correct parts or approved substitutions were used;
- checking damaged components;

- inspecting all soldered joints to assure that all soldering specifications are met; verifying critical lead dress of components, where applicable;
- making sure that all applicable Factory Notices or Engineering Change Notices have been followed; and
- testing electrical performance.

If a lot is rejected, Manufacturing personnel must re-inspect it at 100% and then

submit it again for Quality Control inspection. The defects found by the Manufacturing inspectors and Quality inspectors and testers are fed back to the operators responsible on an hourly basis, and corrective action discussed between Manufacturing and Quality personnel.

Chassis assembly

A chassis is made up of three major assemblies: a deflection module, a signal module, and a power module.

The three parts of the chassis are made separately, then assembled into the chassis unit (Fig. 8). The deflection module contains all of the elements of the deflection circuit of the chassis except the horizontal and vertical modules, which are located in the signal module. The components of the deflection module are assembled to two metal brackets on a chain conveyor (Fig. 9). Most of the operations on the assembly line involve interconnecting the components by means of lead wires that are either crimped and soldered or, wherever possible, wrapped with a wire-wrapping gun around a stake or terminal. Because of the high voltages encountered in this circuit, soldering is closely controlled to avoid sharp points or excessive amounts of solder that may cause arcing. Also, the dressing of lead wires and components away from critical areas must be controlled, either by the use of mechanical aids such as wire ties or clips, or by manually dressing them.

The signal module is assembled on a belt conveyor (Fig. 10). Its metal frame holds seven different modules and an interconnect board; a large number of lead wires connect the modules among themselves or to components in the deflection or power modules. Because the large number of wires produces the possibility of wiring errors, a wiring tester verifies all wire connections.

After a visual inspection on their respective assembly lines, both the deflection and the signal modules are tested using automatic test equipment. Although all their boards and modules had been previously tested individually, sometimes the major assemblies fail to pass one or more of the test specifications. This redundancy in testing significantly decreases the number of failures found at the chassis or instrument test stations.

The power module is assembled on the same belt as the signal module and then



Fig. 9
Deflection modules are assembled on a chain conveyor; most of the assembly work consists of interconnecting wires by crimping, soldering, and wire-wrapping.



Fig. 10
Signal modules are assembled on a belt conveyor. Their metal frames hold seven smaller modules, an interconnect board, and wiring.

attached to it before being transferred by an overhead conveyor to the final assembly line. The same overhead conveyor also transfers the deflection module to the final assembly line, where the deflection and signal modules are married into the chassis base module. These modules are then performance tested (Fig. 11) by attaching the chassis externally to a specially adapted CTC-92 instrument and ascertaining that:

- all the customer and service controls operate properly;
- the chassis performs properly, done by observing picture details and taking pertinent electrical measurements; and
- no intermittent connections are evident, as determined by the "flashes when tapped" test.

Also, the HEW shock-protection circuit is exercised during the test. The last operation before packing the unit, after the final quality inspection, is an AC-DC Hi-pot test designed to detect potential consumer-safety-related failures.

Checking outgoing quality

The quality of the chassis assemblies and of the finished chassis is monitored by two separate quality groups.

One group of inspectors is stationed at the end of each line; they inspect the same

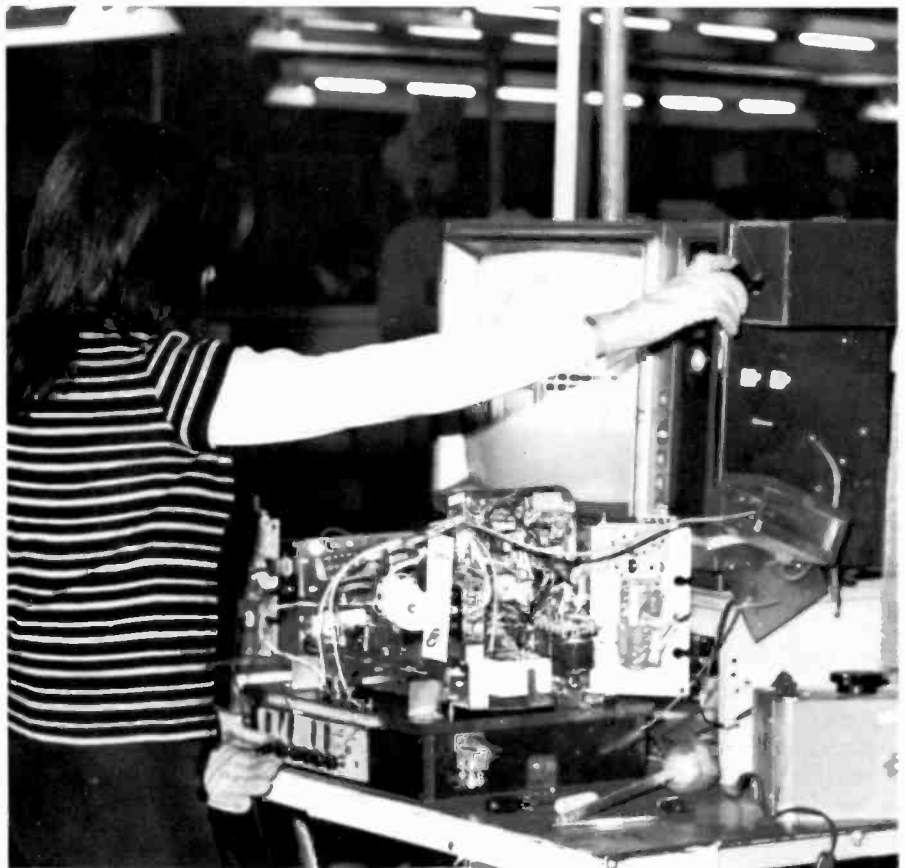

Fig. 11
Performance testing is done by externally attaching the finished chassis to a specially adapted tv set.

parameters as those indicated in the assembly of boards. The sampling plan is somewhat different from the one for boards in that the assemblies or chassis are not batched to draw the sample; instead, a continuous sampling plan is used. This inspection provides an immediate and accurate indication of the quality of the product being assembled. Whenever a defect is detected, the information is fed back to the line supervisor and group leader responsible, to determine its cause and avoid its being repeated.

The second quality group monitors the quality of the finished chassis to certify that it meets a predetermined AQL before it is shipped to the instrument assembly plants. For an AQL of 2.5%, 20 units are inspected out of each lot of 420 chassis; the lot is rejected if two or more defects are found. Because of the small sample size, this inspection is very thorough; it covers all soldered joints, damaged wires or parts, critical lead dressing of components and wires, verification of parts against drawing list, mechanical dimensions, and electrical performance. If a lot is rejected, manufacturing personnel reinspects and retests it 100% before submitting it again for approval.

Consumer Electronics performs environmental and evaluation tests of final instruments and subassemblies as a standard practice.

In compliance with this policy, the chassis are subjected to humidity and life tests on a sampling basis. For the humidity test, one chassis per line per week is placed in a chamber at a temperature of 100°F and relative humidity of 95% for 24 hours. The chassis is connected to an instrument and its performance is evaluated before and after the test.

The life test is designed to detect early life failures, particularly those that may become epidemic, to contain them before the sets reach the consumer. There are three levels of testing:

20 hr	20 chassis per line per day
100 hr	10 chassis per line per day
500 hr	1 chassis per line per day

The test is performed in a 90°F environment, at 130 volts AC, with the sets operating in a two-hour-on/one-hour-off cycle.

Since the chassis are shipped to the instrument assembly plants, a "shake and drop"

test is performed to detect potential damage that may be caused during transportation and handling of the chassis cartons. One carton (12 chassis) per shift is placed on a shake table for one hour at one "g"; the carton is rotated 90° every 15 minutes. At the end of this test, the carton is placed on a cart and allowed to slide 51.8 inches down a 10° ramp from a 9-inch height against a wooden stop. After this test, all 12 chassis are given a complete inspection and any failures are investigated by Manufacturing, Quality, and Resident

Engineering to determine if corrective action is required.

Conclusion

Making 6000 tv chassis a day is not easy; making 6000 *quality* chassis a day is even more difficult. Producing to high standards requires sophisticated assembly and testing equipment; it also requires manufacturing engineers who can work with the new technology that goes with this equipment.

Reprint RE-24-4-5|Final manuscript received August 10, 1978.

Profile of an engineer at CE's Juarez plant

Ed. Note: *Are engineers at RCA's international locations much different from their American counterparts? Yes and no, it turns out. The engineer profiled here, Jesus Parada, is fairly typical of RCA Juarez's engineering staff: he is relatively young, well-educated, and is keeping technically up to date.*



Jesus Alfonso Parada

In his childhood and youth, Jesus was a tinkerer who liked to build and fix things like radios and cars, even though he had no engineer role models in his family. His interests guided him in this direction and eventually into engineering. He attended the elementary (6 years) and secondary (3 years) schools in his home town of Parral (population 30,000), then spent two years at the Chihuahua State University. His professional training was at the Instituto Tecnológico y de estudios superiores de Monterrey, one of Mexico's top engineering schools, where he graduated in electrical engineering after four years in May of 1977. His final project was a two-month assignment at HYLSA, a large metal sheet manufacturer.

Shortly after graduating, Jesus joined RCA in Juarez where he has been active as a test engineer. His responsibilities cover IC testers in the production process; he is also developing hardware and software for computer-based testing on new circuit boards scheduled for production.

Although with RCA less than two years, Jesus has already taken two CE courses (C51 and C55) and two-week training sessions at Hewlett Packard (Mountainview, Colorado) and Systemation Machines (Albany, New York).

In addition to thoroughly enjoying his work at the plant, which moves at a hectic pace, Jesus pursues such hobbies as racquetball, jogging, and instrumental music.

Automatic testing— the way to build a better tv chassis for less money

B.L. Borman

Defects must be found and weeded out of the manufacturing process as early as possible, and automated testing can do just that. It also is faster and eliminates subjective "educated guesses" on the part of the test operator.

Color television receivers represent a mature technology. Recent performance improvements have been evolutionary and tend to occur in small incremental steps. A revolutionary step-function improvement, as occurred with the transition from black-and-white to color, does not appear imminent. Although many consumers perceive significant performance differences among models and manufacturers, there is also

great concern about non-performance-related factors. Thus it is understandable that many consumers include price, reliability, and styling among their primary purchase criteria. Most manufacturers therefore put a strong emphasis on building better sets for less money.

Engineers at Consumer Electronics, working with RCA Laboratories, recently developed and installed an automated test system that has significantly reduced manufacturing costs and improved product quality. This system, which was installed in RCA's Taiwan and Juarez plants during 1976, rapidly and precisely tests television subassemblies before they are shipped to the final assembly plant at Bloomington, Ind. In this way, defects are contained in the plant where they are made, a system that is more cost-effective than identifying and repairing defects in a fully assembled chassis.

Beyond lower product cost and improved quality, the data from precise, extensive automatic testing has significantly improved our ability to control and reduce the level of in-process rejects. Because data can now be matched, on a unit-by-unit basis, against established test limits and under precise computer control, test profiles can be developed to show design trends. Thus, product designs can be improved to be less sensitive to process and materials variations. Also, information on workmanship and material rejects is available in great detail in real time, allowing such problems to be identified and solved more rapidly.

System description and advantages

The basic automatic testing concept applies signal sources and measurement

devices under minicomputer control, to perform rapid, precise, and complete tests on the seven basic television modules: chroma; sound; vertical; horizontal; luminance; signal; and deflection.

Minimum operator intervention. This system eliminates operator decisions and thereby eliminates ambiguity in test results, reduces human errors, and speeds the testing procedure.

High throughput rate. Because this is a production system, one measure of its success is the time needed to test a unit. The systems being used now have reduced the testing time virtually to the settling time of the circuits being tested or, where adjustments are needed, the dexterity of the operator.

Information gathering. Statistical data on each test parameter for each unit tested is stored and used as product-design feedback and to show trends in workmanship and materials.

Standardization. To reduce spares requirements, to simplify training needs, and to reduce costs, hardware and software modules were developed to be applied extensively throughout the system. Also, off-the-shelf modules were used for signal sources and measurement devices wherever practicable.

The software is easy to modify. The UUT (Unit Under Test) software is modular and based on a FORTRAN-structured language; certain changes, such as limits, can be made on-site conversationally.

The FORTRAN method of operation has a number of advantages. For one, it allows self-executing test procedures, which allow the system to operate faster than a conver-



Ben Borman is Manager of the Test Technology Group at Consumer Electronics. He contributed significantly to the development of the test system described in this article, both in the overall system concept and specific modules.

Contact him at:
Test Technology
Consumer Electronics
Indianapolis, Ind.
Ext. 5648

sational system. FORTRAN also allows unlimited algebraic and trigonometric calculations (SQRT, SIN, COS, EXP, etc.).

The software is relatively easy to follow. This typical example of a FORTRAN UUT language illustrates how the software can select the desired stimulus, route the stimulus selected to a specified test point, and control the measurement system.

STEP 1: Apply the DC supply number 1 (28 V) to test point number 6.
CALL DC (1,6)

STEP 2: Set the programmable attenuator to 30 dB.
CALL ATTN (30)

STEP 3: Route the video signal to test point number 8.
CALL VIDEO (8)

STEP 4: Measure test point 15, 20 μ s after horizontal sync and set X equal to the measured value.
CALL MEAS (15, 20, H, X)

STEP 5: Compare the measured value X against test limit number 12.
CALL LIMIT (X, 12)

This software can direct the test-station hardware to perform the desired functional test automatically. The example also illustrates the software's flexibility; commands could be inserted, deleted, or modified easily to achieve the desired test.

Several modes of operation, other than the normal production mode, are included in the system to aid system maintenance and verification.

What the system provides

The system provides the Engineering and Quality departments with test data that was previously not available, such as the histogram shown in Fig. 1. This data is comprehensive and virtually independent of operator performance and interpretation. It is the basis for many technical decisions involving day-to-day operation in the factory. It shows:

- incorrectly manufactured modules;
- the effect of process changes;
- drift in alignment sources and procedures;
- the effect of deviations in component specifications on module performance;
- changes in performance caused by design change; and

What do users say?

Mr. Ben Borman:

Automatic Test Equipment is a program that I visualize as on-going and endless in that development and capability will increase; however, it is appropriate and timely to look at and recognize what has been accomplished to date specifically here at Juarez.

As a result of many groups' efforts, but primarily the efforts of you and your associates, the Juarez Plant is utilizing ATE on every application for which it was projected to be utilized. Up time of the equipment is satisfactory. Test results as measured by the instrument initial CAL index are already better than any product we have ever built before. Engineering, Manufacturing and Quality are obtaining statistical data that reports yields, faults, etc., for corrective action on a daily per-shift basis.

The many personal sacrifices of your engineers and technicians both in Indianapolis and here in Juarez are paying off now in the plants and will impact directly on the market place when the new line is introduced shortly.

In summary, the program is a success.

My congratulations to you and your group for a job well done and timely executed.

Paul Belanger
Manufacturing Engineering
Juarez

	RAW	RETEST														
ACCEPT	1938	184														
REJECT	391	114														
ABORTED	101	37														
	2430	335														
N#	QTY	%	/	-	15	15	*	15	20	30	20	15	*	15	15	-
1	0	00.00	0	0	0	*	0	0	100	0	0	*	0	0	0	
2	0	00.00	0	0	0	*	0	0	95	5	0	*	0	0	0	
3	0	00.00	0	0	0	*	0	38	61	1	0	*	0	0	0	
4	12	0.52	0	0	0	*	0	3	62	33	1	*	0	0	0	
5	40	1.72	0	0	1	*	6	25	50	16	1	*	0	0	0	
6	12	0.52	0	0	0	*	0	1	66	32	0	*	0	0	0	
7	33	1.42	0	0	1	*	3	10	43	40	3	*	0	0	1	
8	0	00.00	0	0	0	*	0	1	6	84	9	*	0	0	0	
9	8	0.34	0	0	0	*	0	1	82	16	0	*	0	0	0	
10	11	0.47	0	0	0	*	0	0	86	13	0	*	0	0	0	
11	3	0.13	0	0	0	*	0	12	87	0	0	*	0	0	0	
12	15	0.64	0	0	0	*	0	2	77	20	0	*	0	0	0	
13	52	2.23	1	0	0	*	0	17	37	36	8	*	0	1	0	
15	11	0.47	0	0	0	*	0	0	0	0	100	*	0	0	0	
16	20	0.86	0	0	0	*	0	0	0	1	98	*	0	0	0	
17	35	1.50	0	0	1	*	2	12	45	37	2	*	0	0	0	
18	8	0.34	0	0	0	*	2	3	27	49	19	*	0	0	0	
19	17	0.73	0	0	0	*	0	40	59	0	0	*	0	0	0	
20	75	3.22	1	0	2	*	3	14	52	25	3	*	1	0	0	
21	29	1.25	0	0	1	*	0	39	60	0	0	*	0	0	0	
22	33	1.42	0	0	0	*	55	10	15	5	2	*	0	0	0	
23	22	0.94	1	0	0	*	0	0	5	71	23	*	0	0	0	
24	96	4.12	1	0	0	*	0	1	30	39	25	*	3	0	0	
25	26	1.12	0	0	0	*	62	10	17	7	3	*	0	0	0	
26	16	0.69	0	0	0	*	0	1	11	12	76	*	1	0	0	
27	1	0.04	0	0	0	*	0	1	5	85	8	*	0	0	0	
28	34	1.46	1	0	0	*	1	29	61	7	0	*	0	0	0	
29	5	0.21	0	0	0	*	38	42	19	1	0	*	0	0	0	
30	4	0.17	0	0	0	*	2	97	0	0	0	*	0	0	0	
31	30	1.29	0	0	0	*	0	0	18	60	20	*	0	0	1	
32	43	1.85	0	0	0	*	0	4	42	45	7	*	0	0	1	
33	5	0.21	0	0	0	*	0	0	100	0	0	*	0	0	0	
CLEAR?																
?YES																

Fig. 1
Typical histogram output gives results at a glance. The asterisks define the upper and lower limits for this test; the numbers in the columns are the percentages of the product that fall within the windows of the specification (shown across the top of the form).

Fig. 2
System I, the evaluation and test-program-development system, consists of a single dedicated controller and seven individual module-function-testing units.

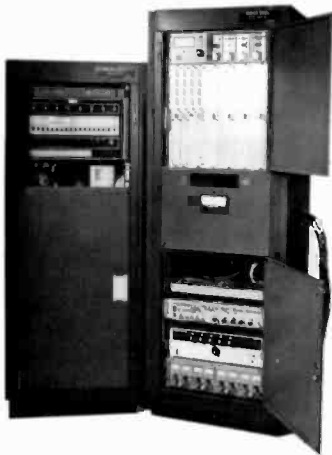

Controller
Master Signal Stand

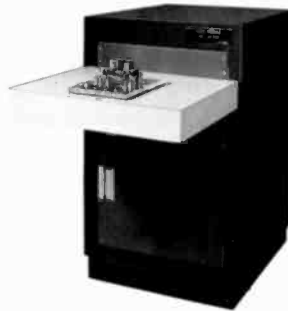

Vertical Tester



Horizontal Tester



Signal Package Tester



Luminance Tester



Sound Tester



Chroma Tester

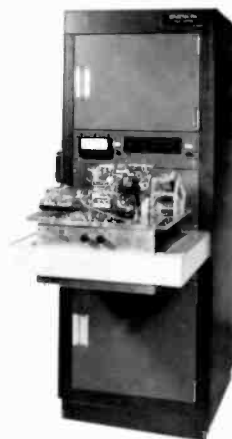

Deflection Package Tester

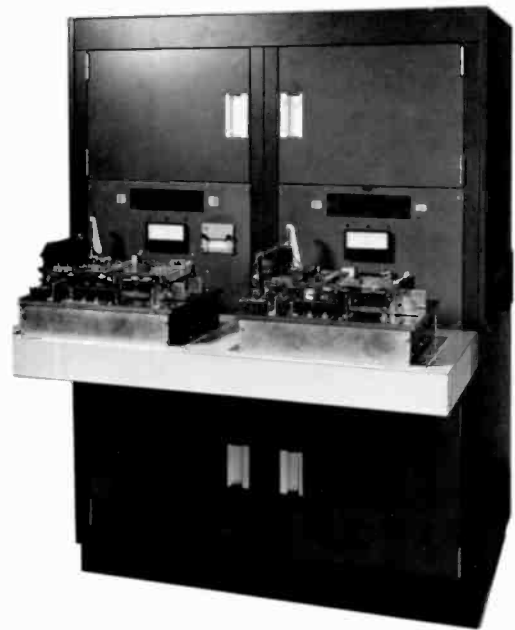

Fig. 3
System II is for production testing. Here, the seven individual test stands have their own controllers and signal sources. Each stand can test two modules independently at the same time. This stand, the signal-package unit, is also shown in block-diagram form in Fig. 4.

slowly changing performance, which becomes significant after several weeks.

Designing for ATE

A major effort toward putting the automatic test equipment on-line was to establish test requirements:

Which functions must be tested?

How many test are required?

What test limits must be established to adequately test each module on a go/no-go basis?

In general terms, the product had to be redesigned to accommodate automated testing. Objective specifications, capable of machine interpretation, were developed and test points were specified. Past manual testing methods, for example, required the operator to analyze various tv test waveforms subjectively. When these subjective analyses were translated to specifications objectively measureable by the automatic test equipment, the result was a more thoroughly analyzed product.

Each test specification is complex (i.e., multiple measurements required and calculations performed) and demands a thorough analysis by the design and test engineers. For high-volume production it

Table I
The number of tests and test specifications is impressive, especially when one realizes that the test time per module is essentially the settling time for the circuit.

	Number of test points accessed	Number of test specification
Deflection package	32	50
Signal package	34	78
Chroma	16	28
Sound	10	17
Luminance	16	35
Vertical	11	24
Horizontal	12	24

Table II
Purchased off-the-shelf parts were used wherever possible in the automated equipment.

PRD frequency synthesizer	Programmable attenuator
RCA modulator, Model CTM-1	210 V power supply
+5, +15, -15 V Lambda power supply	+27 V power supply
+28 V Lambda power supply	Digital Input
0-40 V dual Lambda power supply	Digital Outputs
Tektronix 140 test signal generator	Digital to Analog Converters
Burroughs display	Analog to Digital Converter
PA printer	Multiplexor for A/D Converter
Dual 45 V power supply	Interrupt Interface Module
0-120 V power supply	General Automation, Model 16/45
0-240 V power supply	control system (including input/output)

is essential that specifications are considered for the overall receiver performance criteria rather than the capability of the individual circuit function. Table I summarizes the number of test specifications and test points accessed for each circuit function.

The two systems

Two basic systems configurations were developed. System I, shown in Fig. 2, is used for quality control, engineering evaluation, and test-program development. It consists of a single, dedicated controller, a master signal stand, and individual units for each module function to be tested. One such system is located in Indianapolis, and another in Juarez.

System II, shown in Fig. 3, is the production testing system. It consists of seven test stands, each with its own controller and signal sources. A block diagram of a typical system is shown in Fig. 4. Each test stand allows two units to be tested at the same time, providing greater throughput.

The hardware

As mentioned previously, wherever possible, signal sources, measurement devices, or control modules were purchased as off-the-shelf items; Table II lists the modules purchased for this system.

When no off-the-shelf components could be found, the Test Technology group developed special modules. A number of these modules are shown in Fig. 4; all of them are described below.

The deflection-pulse generator simulates the horizontal and vertical rate pulses found in the deflection circuits of the television receiver.

This module provides four independent outputs (two vertical and two horizontal rate pulses) that are enabled by logic signals. The low-voltage waveform from the horizontal output is stepped up by a small transformer near the unit under test. All outputs are tolerant to faults in the unit under test.

The phase-converter module measures the phase relationships of the demodulated chroma signals.

It works in conjunction with the chroma-sources module, which provides the special-purpose signals for this measurement. An automatic level-shifting circuit removes the dc component from the input, and so allows "zero" crossings of the demodulated signal to be detected more accurately. The phase resolution is one degree. The output is a binary number via a tri-state buffer.

The voltage-controlled-oscillator module allows high-speed frequency-response measurements when used in conjunction with the 10-ns sampler.

This module contains two gateable, independent voltage-controlled oscillators; one provides a sinusoidal output that is dc-programmable from 40 kHz to 4 MHz. When the gate is enabled, the sinewave starts positive-going from zero, thus locking the output to line timing. Waveform peaks are a function of frequency and line timing, and so are readily measurable.

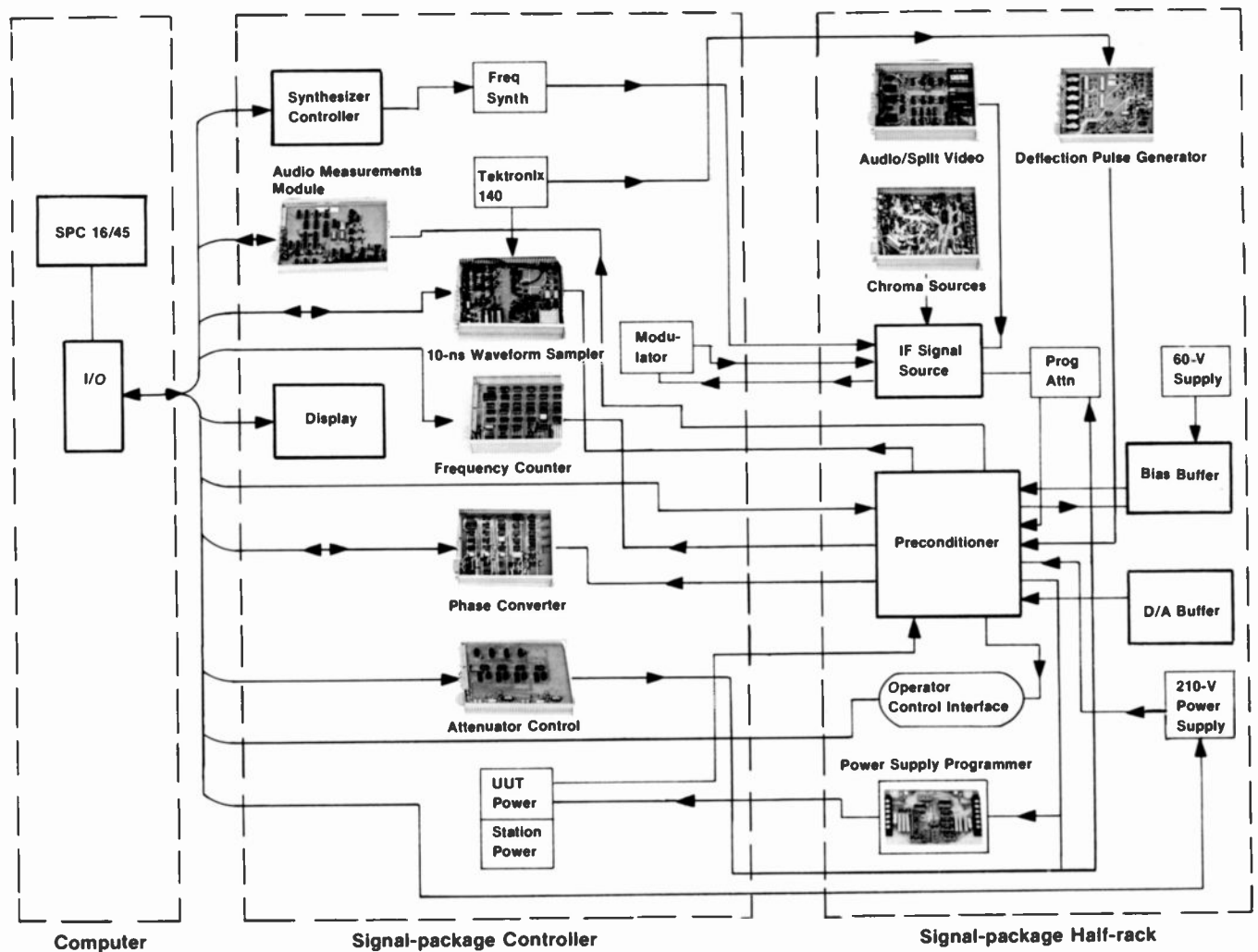

Fig. 4
Typical tester uses both purchased parts and RCA-designed modules. Testers were designed to be as modular as possible to reduce cost, spares requirements, and training. This tester, the signal-package unit, essentially consists of the computer and its associated software, the controller section, and testing interfaces for two units.

The frequency-counter module contains a special-purpose counter circuit capable of measuring signals common to tv systems.

Depending on the signal to be measured, different counting techniques are used to minimize the measurement time. For example, the 3.58-MHz chroma-oscillator signal is measured with 1-Hz resolution in approximately 1 ms, whereas a conventional counter might require 1 s for this resolution. The module can also measure pulsewidths with 50-ns resolution. The output is a binary number via a tri-state buffer.

The audio/split video module measures the black-to-white video output at the kine driver of the unit under test.

Although black level was available on a full-line white signal at the back or front

porch of blanking, the whole blanking and sync interval was not available at the kine driver output of the unit under test because of the width of the horizontal retrace blanking. Therefore, a circuit was developed to allow a programmable logic-level signal of half black and half white lines with the option to also have a split field as well (all lines black during the first half, and each line black-to-white during the last half). This logic-level signal goes to the I.F. sources module to be translated to video voltage levels and to be sent to the I.F. modulator. Also, sound tests of distortion and frequency response require two audio frequencies to be modulated on the sound carrier at a specified fm deviation. The module generates the two frequencies, programmable to three levels. All video and audio outputs of this module to the two halves of the test station are completely independent.

The chroma-sources module provides several logic-programmable burst-to-chrominance ratios.

The chrominance output may be either of two distinct frequencies—3.53 MHz for amplitude measurements and 3.56 MHz for phase measurements. This module also adds blanking and burst to a cw signal from an external frequency synthesizer.

The 10-ns waveform sampler is a practical way to sample a full-field television test signal with 10-ns resolution.

Very fast real-time sampling systems such as those used for time-base correction presented the problem of storing the sampled data at a real-time rate. Asynchronous sampling schemes available were judged too slow to obtain a sufficient number of samples. This 10-ns sampler examines one point from each horizontal

line in a field and therefore can look at approximately a 2.5- μ s segment of a video waveform during each field. The sampler also provides basic timing information for the system sync generator so sampling is synchronous with the video signal. Line-to-line jitter is about 600 ps.

The sync generator module provides a compact, inexpensive source of NTSC timing signals.

Its unique capability to provide a precise one-time phase transient on command allows horizontal AFC loop measurements (i.e., the 24th line of field 1 is 58.67 μ s). To facilitate video measurements, the sync generator is locked to a master oscillator in the 10-ns sampler. Short-term stability is 5×10^{-10} parts per second and long-term is 1×10^{-6} parts per year.

The audio measurements module is a multi-purpose device.

It can measure both positive and negative peak amplitudes of waveforms from dc to 40 kHz by using a fast closed-loop integrating-type detector. It can also make true rms measurements from 20 Hz to 40 kHz and can, under program control, insert a 10-pole active high-pass filter with a cutoff frequency of 700 Hz for measuring distortion products of a 400-Hz signal. The module has three programmable gains and has an input impedance of 1 megohm.

Two basic types of power-supply programmers were developed to control a wide range of commercially available power supplies.

If a supply must be "fully programmable," the programmer receives a dc voltage from a D/A converter and supplies the gain needed to generate the control voltage for that particular power supply. The supply can be set to any voltage within its range by setting the D/A voltage. This type of programming is currently being used in various voltage ranges up to 200 V. The second type, called a "step programmer," can set the supply to a voltage by switching fixed resistors to the supply's programming input. Two control bits are used to select one of four preset voltages. This type of programmer is currently used for various supply voltages from -40 to 250 V.

Three source modules provide signals necessary for testing.

The luminance-sources module takes the NTSC timing signals from the sync generator and generates composite video

and a gate signal to enable the voltage-controlled oscillator. A special feature is that sync and pedestal levels are programmed by a dc voltage input. (10V = 100 IRE units)

The audio-sources module provides a 4.5-MHz signal for testing sound modules. It permits program control of modulating frequency and the deviation. The module also contains an a.m. section for use in a.m. rejection measurements.

The i.f. sources module was developed to provide the test signals required at the input to the i.f. module in the tv receiver. Providing these test signals requires the combining and processing of signals from a variety of other sources.

In addition, the following boards were designed because no commercial equipment was available:

The *Display Controller Board* decodes bit patterns for the Burroughs display, reject, and accept lights. The *Decoder Driver*, one logic board, decodes six bits to 32 line relay drivers. The *Printer Interface*, one board, works with the decoded bit pattern logic of the display controller board, interfacing logic change for a Practical Automation printer. The *Frequency Control Board* is a latch for the frequency synthesizer unit, needed for logic lines controlling more than one device. The *Attenuator Control Board* holds logic for the attenuator unit, for logic lines controlling more than one device.

For ease of service and for standardization, these modules are used in many places throughout the system. For example, the 10-ns waveform sampler is used in every station except the Sound Module Tester.

Conclusion

This system performs functional tests of television modules. It provides television broadcast signals, customer functions, and interface signals normally received from other parts of a television receiver so that the module will operate as it does in a completed television instrument. This assures that the module will perform satisfactorily in a system environment later, and that it will not become a "line pull" somewhere downstream in the manufacturing cycle.

CE's Quality Assurance Program produces quality television sets

J.R. Smith|J.D. Eaton
H.E. Elrod|D.H. Slider

A well-defined quality program is necessary to produce televisions that the buying public will accept. This program must test quality before, during, and after the manufacturing process.

RCA's Consumer Electronics Division manufactures products to the highest practical standards of reliability and quality. These standards are established by consumer acceptance and competition in the marketplace. To ensure that the product sold to the consumer is consistent with these standards, Consumer Electronics follows a well-defined Quality Assurance Program.

The four basic areas involved in this program include: a system of checking the quality of the incoming components and tracking them through subassembly and final assembly; specific factory quality-control systems; and a final Consumer Acceptance Laboratory separate from the manufacturing operation.

Before Purchased Material Quality Assurance (PMQA)

Component quality and reliability failures account for approximately 50% of the total

in-house and field failure rates, producing an annual warranty cost of approximately 15% of the total cost of quality. Because of this high cost, a significant part of the total quality system is directed toward PMQA, encompassing quality and reliability allocations, vendor quality and reliability requirements, Engineering and Manufacturing approval, incoming inspection, performance tracking, and corrective action.

Each year numerical quality and reliability requirements are established for the finished product.

Once these requirements are established for the instrument, the results are allocated as quality and reliability requirements down to the piece-part level. These requirements can then be included in purchase specifications and be used to provide design requirements for portions of the instrument against which design progress can be checked. The basis used for allocating the total instrument requirements down to the piece-part level is a combination of experience, published in-

dustry and government data, supplier inputs, and mathematical techniques.

The quality and reliability requirements resulting from the allocation process described above are passed on to vendors.

RCA uses two specifications, QRSM-III-A and QRSM-III-D, which are made a part of material purchase contracts, to make sure that its quality goals are met.

QRSM-III-A specifies the minimum quality and reliability systems requirements that vendors supplying material to CE must meet. Some of the major elements covered in the specification are acceptable quality levels (AQLs) for various categories of material, inspection systems, corrective action, and change control.

QRSM-III-D specifies the minimum general reliability test requirements that vendors must meet. Requirements for selected parts are specified in supplements to the general specification. Items covered include test quantities, test conditions,

Before manufacturing starts, components must be tested for quality and reliability. The flowchart for quality testing of semiconductors, for example, involves about thirty steps. Although the entire sequence is too lengthy to reproduce here, it contains physical and electrical testing plus burn-in life testing. Some

examples of this work are in these photos. From left to right: a semiconductor probe station; scanning electron microscope display showing voltage contrast across IC metallization; operator using scanning electron microscope.

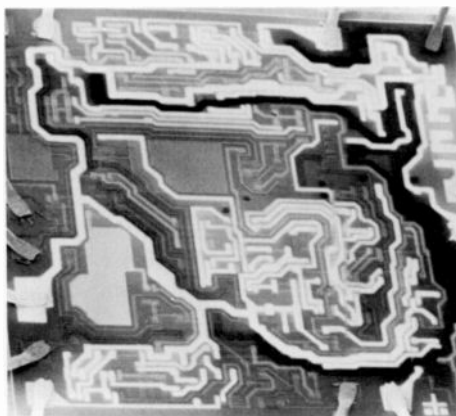

frequency of tests, pre-conditioning of test samples, action to be taken when failures occur, failure analysis, reporting, and corrective action.

Presently, the supplements to QRSM-III-D are developed as an "add-on" to existing purchasing contracts. A supplement specification is first drafted by CE Quality Assurance and transmitted to the appropriate vendors for their review and comments. The vendor is encouraged to submit a counter-proposal that will satisfy the basic requirements yet match his physical capabilities and existing quality and reliability system.

New material must be approved by both Design Engineering and Manufacturing Operations in the manufacturing facility receiving the material.

These qualifying approvals are called the "E" and "M" approvals, respectively. "E" approval, usually performed during the design and development cycle, assures that the design of the material meets requirements. For "M" approval, performed subsequent to "E" approval, the vendor must submit material from a production run using tools, processes, and materials that will be used to supply production quantities of material. Although Engineering is responsible for "E" approval, the Component Reliability Laboratory (CRL) within CE Division Quality Assurance supports the "E" approval evaluation of semiconductors.

Each CE manufacturing facility has a Purchased Material Inspection (PMI) group, which is a part of the plant Quality Control department.

The primary responsibility of PMI is to assure that purchased material and material received from other CE plants complies with specifications and drawings. The major elements of the PMI inspection system are checklists, sampling plans, test procedures, disposition of rejected material, and record keeping.

Checklists serve as the basic work instruction for the material inspectors and usually contain only the critical items in the material specifications to make the process cost-effective. The sampling plans used by PMI are based on MIL-STD-105D, In-

spection Level II. Some AQLs being used presently are:

Part Type	AQL
Resistors, capacitors, inductors	0.25%
Diodes, transistors	0.10%
Integrated circuits	0.25%
Major subassemblies	0.65%

This means, for example, that the average percentage of defective resistors must be no greater than 0.25%. Some 100% inspection is being used also and is discussed later.

Jack Eaton has over seventeen years experience in Quality Assurance Engineering on electronic systems for aerospace vehicles, automotive products, and consumer products. He is currently Manager, Quality Systems and Procedures, and is responsible for developing quality systems within the Consumer Electronics Division.

Contact him at:
**Quality Assurance, Consumer Electronics
Indianapolis, Ind. Ext. 5387**

Hoyt Elrod has over fifteen years experience in managing quality and reliability for military, industrial, and commercial electronics equipment manufacturing. He is currently Manager of Component Quality Assurance, which includes the Component Reliability Laboratory in Bloomington, with responsibility for the quality and reliability assurance of purchased solid-state devices used by Consumer Electronics.

Contact him at:
**Quality Assurance, Consumer Electronics
Indianapolis, Ind. Ext. 5385**

Test procedures, unless specified in material specifications, are developed by each PMI group with the assistance of the Plant Resident Engineering (the design/factory liaison) group. Rejected material is usually returned to the supplier, but if it is needed to support production, then a Material Review Board decides if the material can be reworked or sorted. PMI maintains the inspection results for each lot of material by part number and vendor. These records, usually referred to as "Vendor History File," are then used to

Don Slider joined RCA/CE in 1967 as a Quality Assurance Engineer and has been responsible for data collection, analysis, and problem-solution tracking since that time. During that period he has participated in data-gathering systems development for manufacturing and field-performance evaluation. He is presently responsible for Quality Assurance Administration for the Consumer Electronics Division.

Contact him at:
**Quality Assurance, Consumer Electronics
Indianapolis, Ind. Ext. 5382**

Jim Smith has twenty-eight years of experience in all aspects of Quality Control, Quality Assurance, and Reliability in CE and DEP. He is currently Manager, Division Quality Assurance.

Contact him at:
**Quality Assurance, Consumer Electronics
Indianapolis, Ind. Ext. 5388**

Scrutinizing a CTC-87A tv chassis are, left to right: Smith (seated), Elrod, Slider, and Eaton.

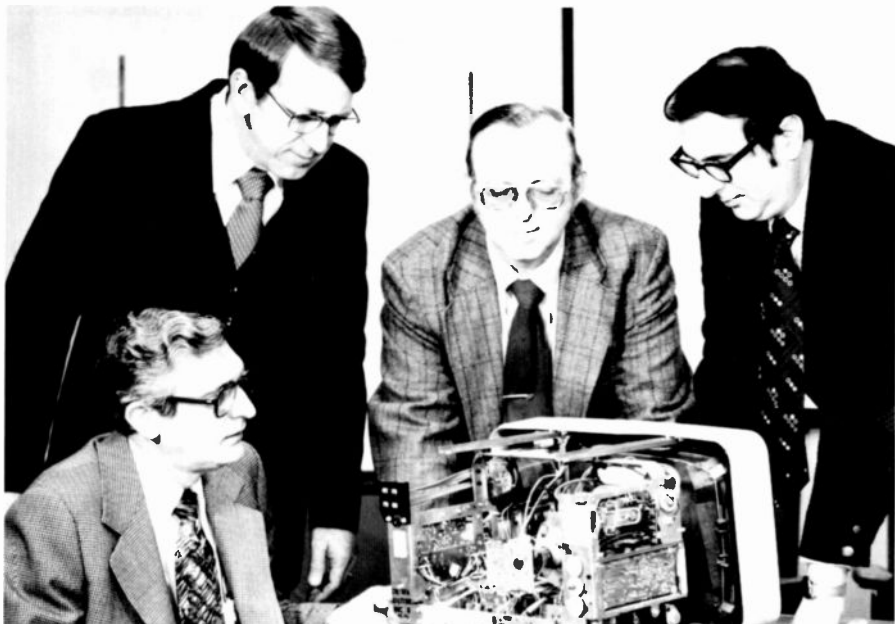

Reprint RE-24-4-7
Final manuscript received August 10, 1978.

determine if skip-lot, reduced, normal, or tightened inspection is warranted.

During the first quarter of 1978, CE began to manufacture a new tv chassis using a new (to CE) manufacturing process. The incoming material inspection procedure for supporting this manufacturing process is to 100%-inspect all material where practical. CE has been nearly 100% successful in the area of electronic components, such as resistors, capacitors, diodes, transistors and integrated circuits. The 100% semiconductor inspection includes 100% preconditioning before electrical test: the preconditioning consists of a 24-hour 125°C bake followed by 10 air-to-air temperature cycles of -55°C to +125°C.

During Performance tracking, evaluation, and corrective action

The performance of purchased material is measured at PMI, through the entire manufacturing process, and in the final instrument.

The following five data systems make this performance tracking possible.

Vendor Rating. This data system uses the PMI inspection results from every CE plant as its inputs. The monthly and quarterly reports generated from this data base rate the quality performance of each vendor supplying material to CE. Awards for excellence are given quarterly to selected vendors. Vendors whose performance is not satisfactory are also identified, and then requested to initiate quality improvement programs.

Appraisal Material Purchase Systems (AMPS). The data from this system provides a detailed breakdown of vendor quality performance for each plant by part number, vendor, percentage defective, and the major categories of defects found at incoming inspection. An analysis of the data for a problem vendor provides the basis for corrective action by the vendor.

Defects Reporting System (DRS). This data system accumulates troubleshooting (diagnostic) data of factory process failures by chassis type listing cause and symptom defects. This data is evaluated for the possibility of improving material specifications, part

application, PMI inspection, or the vendor's part design or manufacturing process.

Solid State Performance Report. This report identifies monthly usage and in-process failures for line-reject solid-state parts by part number and vendor. The analysis of the data in this report compares vendors supplying parts to the same specification, shows overall vendor performance, and gives performance trends.

Consumer Acceptance Laboratory (CAL) Reports. Reports from this laboratory (the details of CAL are discussed later) indicate the actual performance of finished product. The data are analyzed daily, weekly, and monthly to detect catastrophic or acute failure-trend patterns and provide input to corrective-action systems.

Results from the data systems outlined above trigger investigations and analyses followed by corrective action by the vendor and/or CE. Later sets of results are then used to measure the effectiveness of the corrective action.

Solid-state devices may require special reliability tests and physics-of-failure analyses to be performed by the Component Reliability Laboratory (CRL) within Quality Assurance. CRL can, if required, do die probing and perform microscopic examinations with the aid of a scanning electron microscope. Special accelerated life tests can also be performed in order to verify the effectiveness of certain screening techniques that may be proposed to improve the reliability performance of devices under investigation.

After Factory quality-control systems

Although checking the quality of individual components is important to overall quality, the quality and reliability of the finished product must also be established. This is done at CE's manufacturing plants as Product Prove-in and Product Assurance Plans.

The prove-in of a new model product consists of a pilot build and a preproduction build of complete instruments.

For the pilot build, fifty instruments will be made approximately sixteen to twenty

weeks ahead of production, using parts that are either from or representative of production tools. The principal purposes of this build are to:

- check the form, fit, and function of parts;
- check and develop manufacturing test methods and procedures;
- check product performance;
- check and develop manufacturing processes; and
- check product reliability.

Quality Control checks product reliability by life testing ten pilot instruments for 1000 hours to check for gross unreliability. Five of the ten are subjected to a 24-hour humidity test (95% RH, 37°C) prior to the life test.

Approximately ten to twelve weeks ahead of scheduled production, a preproduction build in the range of 130 to 150 instruments are built using fully "E" approved parts. The major purposes of this build are to:

- obtain final approval of parts;
- verify corrective action taken since the pilot build;
- finalize manufacturing processes; and
- obtain final approval of performance, quality, reliability, and appearance.

A very stringent evaluation is performed on preproduction instruments since they become finished (saleable) goods. The evaluation sample, consisting of 105 instruments, is selected from preproduction. Five of the instruments are used for drawing-list inspection and samples for a View Committee that evaluates appearance. The remaining instruments undergo a 500-hour life test. Before the life test, however, samples are subjected to simulated shipping tests and inspected for consumer acceptance—fifteen undergo shake and drop tests, another fifteen drop and shake tests, twenty resonance vibration tests, and thirty handling simulations.

Throughout the Pilot and Preproduction quality and reliability evaluations, each defect and failure is analyzed by the appropriate organizations and corrective action identified for production start.

Product Assurance Plans are prepared by each plant Quality Control organization and approved by Division Quality Assurance.

These plans define the controls and resources required to meet the final-

product quality objective. For a given final product, such as a color tv instrument using a CTC91 chassis, keyboard frequency-synthesis tuning system and a delta picture tube, the following Product Assurance Plans might be applicable: CTC91 CBM chassis and MSC module (Juarez); MST module (Taiwan); speaker and cabinet (Indianapolis); and the keyboard, tuner assembly, convergence board, and final assembly (Bloomington).

The major elements of a Product Assurance Plan are:

- quality control level (AQL);
- inspection system (location of stations, sample size, checklists, etc.);
- data collection, analysis, and corrective action; and
- resources required.

Preparation of the plans begins with the first issue of New Product Development Schedules. These schedules contain the pilot, preproduction, and production start dates for each product to be manufactured by the various plants. The first draft of a given Product Assurance Plan is submitted to Division QA for review shortly after the pilot build. Plan development is completed before preproduction and fully implemented by production start.

Consumer Acceptance Lab

The Bloomington, Juarez, and Taiwan plants each have a Consumer Acceptance Laboratory (CAL) that conducts sample inspections and reliability tests on ready-to-ship products.

The products that are subjected to sample inspections and reliability testing are components (such as yokes and high-voltage transformers), subassemblies (such as tuners and circuit boards), tv chassis, and finished tv instruments. Although each plant has a CAL operation, only the CAL in the Bloomington facility, which evaluates finished tv product, will be discussed here.

Each model instrument from each production line, each day, undergoes CAL sample inspection.

All samples are taken from finished goods warehouse after the instruments are packed for shipment. The present plan is to sample thirty-two instruments per production line per day and subject a subset of each line sample to a simulated shipping test before inspection. The inspection per-

formed is designed to determine if the instrument would be acceptable to the customer. Functions, picture quality, appearance, and general performance items are checked. Any defect found during the inspection is analyzed to the degree necessary to establish responsibility so that corrective action can be initiated. Rejected lots (an inspection lot is the day's production from a manufacturing line) are resampled to a tightened plan (125 units) to determine final disposition. Reworked lots are reinspected by CAL with regular production.

Reliability testing of finished tv instruments consists of a Mini-Life Test and an Extended (500 hour) Life Test.

Approximately one-half of the instruments subjected to the simulated shipping tests

discussed above are subjected to an 8- to 12-hour Mini-Life test after the inspection is completed. This test measures the early life reliability of the instruments on a daily basis.

For measuring long-term reliability, a 500-hour life test is used. Each day, 67 instruments are selected from a given production line and put on life test. Each production line is sampled in turn. At any given time, 1005 instruments are on test.

Conclusion

Quality and reliability are among the major factors determining consumer acceptance of televisions. The Quality Assurance Program described here, ranging from incoming parts to finished goods, makes quality products a reality.

After manufacturing, the Consumer Acceptance Laboratory takes samples of each day's production and tests those sets to see if they would be acceptable to the consumer. Photos here, clockwise from upper left, show: x-radiation measurements being taken; defect analysis on a 13-inch color tv; resonance test designed to simulate shipping conditions; and life test for 25-inch ColorTrak and 13-inch XL-100 sets. About 1000 instruments are normally being tested at any given time; rejected lots are resampled to determine if rework is necessary.

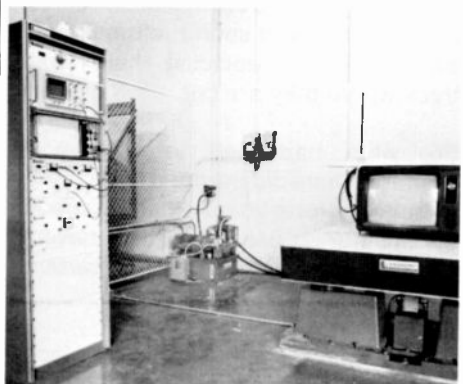

The puzzle of the wood television cabinet

A.E. Bowman

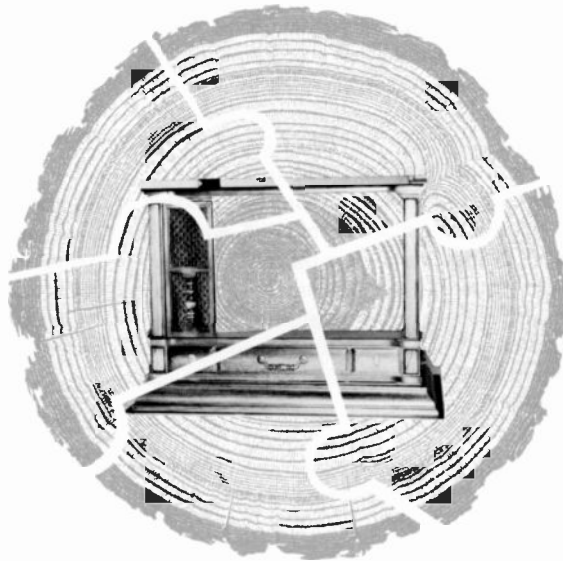

High-volume production starting with a "natural" material produces an interesting combination of hand work and production-line techniques.

Not many manufactured products have the direct relation to nature and creation that furniture does. We tend to think of our wood television cabinets as "natural," rather than "manufactured," products. Because the lumber used as the raw material has all the idiosyncracies and imperfections that make living things interesting, the manufacturing process can be taken as a puzzle—putting together a combination of fast-paced production machinery and the hand work and individual attention woodworking requires. The following paragraphs try to put the pieces of that puzzle together.

Essentially, the wood-furniture tv-cabinet production uses hardwoods, although some pine has been used in recent years. Is there any puzzle with the basic material resource? The general availability of hardwoods is very good. The total supply exceeds the demand. There are millions of acres of hardwood, and sound reforestation programs are replacing hardwood trees where they are cut.

So, what happened to the good walnut? Where did the good cherry go? Despite reforestation that exceeds manufacturing uses, there is a never-ending puzzle of shortages of certain species.

Supply and demand is a puzzle piece with style. Certain species of wood get

into short supply as a particular furniture design or finish begins to have exceptional sales. Oak is a good example. About three years ago, oak lumber was in very good supply and could be purchased at a reasonable cost without sourcing problems. When the sales of oak furniture of different designs and finishes began to escalate, the demand for oak lumber rapidly increased. Even though oak lumber processing increased, the demand still far outweighs the supply. The result: oak is very difficult to purchase and the prices are excessively high.

Geographical location of the lumber is a part of the puzzle. Each particular species of wood has variations in characteristics that relate to where the wood is grown. The growth rings of the tree, the texture of the wood, the knots, and other factors of nature vary with locale and climate. A hardwood tree grown far south will yield lumber with vast differences from the lumber from the same type of tree grown far north.

Cutting and drying cycles, including logging and milling, are part of the processing needed to make the lumber out of the trees. The type of wood, the growth location, and the season of growth present a multi-sided part of the puzzle. The logging, saw-milling, air-drying and oven-drying requirements must be properly timed and controlled to obtain a suitable grade of lumber for

use in wood-cabinet production.

Government involvement is a puzzle piece that is growing in size. It forces other puzzle parts to change as it changes, and may be impossible to control! The Government has ecology in mind when it sets aside forests for wildlife preservation. The problem part of this puzzle piece is forest management. Will there be forest growth and good reforestation planning within the Government programs? A combination of the plans for forest preservation and good forest management can enhance the long-term prospects for hardwood lumber availability.

Product development or planning changes also. Production changes normally relate to changing sales trends. What people want to buy, or will buy, though, is sometimes quite a puzzle. Still, this is vital to getting the development of the product going in a right direction.

Planning and scheduling is a puzzle piece that tries to minimize the problems of getting all the parts put together. This piece bumps up against the product-development part as soon as possible (in the puzzle) to ascertain the right amount of time to design and engineer the furniture-cabinet product. The planning and scheduling carries through to the completion of

the production puzzle part and on to the final selling of the product.

Styling and design engineering are separate parts in the wood cabinet puzzle, but they require an absolute fit. The appearance, the shapes, the lines, the finish, and the look of the product are important. The construction, matching up with stability, is equally important. And, the two must complement each other. Something that looks

very nice but falls apart is a loser; so is an eyesore built with permanence. A beautiful wood furniture-cabinet product that is made to last is the result intended.

Manufacturing engineering is the piece of the puzzle that is positioned alongside the styling and design engineering pieces to insure the fit. The layout and equipment needs, the drawings, processes, and tooling re-

quired, along with the methods of production are determined from the specifications of appearance and construction provided by Styling and Design Engineering. On the other side of the Manufacturing Engineering piece is the production part of the puzzle; these two must be snug, though not an absolute fit. This is where Quality Control enters the picture, moving about, through, and over the puzzle to make sure the size, shape, and

A thumbnail look at large-scale wood manufacturing

The 1000 employees at RCA's Monticello plant produce about 500,000 cabinets each year. Of these, about 80,000 are "conventional" built-up units, the rest are "knockdown" units that are taken apart for shipping and reassembled at the final assembly plant.

The average cabinet requires a little over two hours of direct labor from start to finish, although the range is from the top-of-the-line GC938's four hours down to a little over one hour. This production rate produces 2100 wood consoles per day, starting from about 45,000 board feet of rough lumber.

Producing these cabinets involves an average of 300 total operations to cut, shape, assemble, and finish the 35 or so individual parts per cabinet. There are about 1400 different mill operations in the manufacturing plan, and about 10 models are moving through the mill process at any given time.



Fig. 1
In about three hours, this rough lumber will be all television cabinets and sawdust. The rough lumber arrives at RCA as boards with thicknesses 1" to 2", lengths at 10-12', and average widths of 7". Air- and oven-drying has reduced the moisture content to 6-8%.



Fig. 2
Cutting to length is the first operation. The operator slides the lumber to the saw (at rear), picking out the best lengths and avoiding knots and bad spots in the rough lumber.



Fig. 3
Ripping is a two-person, back-and-forth operation. The operator sends the board through the saw to another operator (out of picture) who passes the cut portion back for another cut. A few seconds ago, this board was about 12" wide; now it's about six pieces like the one you see here.

appearance of the final product are satisfactory.

Production is the multi-sided and constantly changing puzzle part nestled in between the other parts. The production part prefers less mystery, so the total puzzle is easier to solve. Certainly production does not want the puzzle to be a thriller. Production prefers a

romantic puzzle that embraces the beauty of wood and recognizes inherent wood characteristics as attractive birthmarks. It enjoys putting the puzzle together; the work involved with the production puzzle will always be there, but it can be accompanied with the happiness of associating with a product of value.

There can be, there should be, a worthwhile feeling that goes with turning the wood puzzle into television-cabinet form. The single purpose of producing the cabinet does not alter the significance of each side of the production puzzle part: mill machining and machine sanding, subassembly and assembly, pre-finish cleaning and



Fig. 4
Detail parts often have unusual shapes. This numerically controlled router can be reprogrammed for different shapes by changing the tape on the controller at the right. A typical tv cabinet has about 24 exposed detail parts; moulders, autoshapers, and tenon machines are also involved in this work.

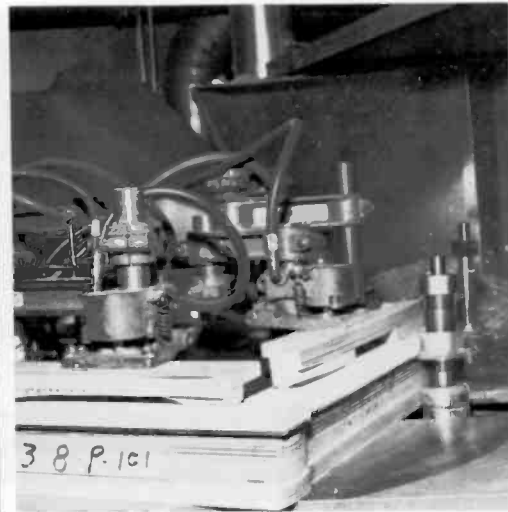

Fig. 5
Chips fly as the autoshaper table rotates past the fixed knife-edge cutting wheel at the right and produces moulding-type curves.



Fig. 6
Sanding this cabinet to a finish that requires the job is done.



Fig. 9
Cleaning up and sanding is an operation that cannot be done by machine. The glue, wood chips, and some wood-filling material must be removed, and then the wood must be sanded, before the cabinet gets its finishing coats. This "white wood preparation" is very important to the finished quality of the cabinet.



Fig. 10
Finishing requires many coats—three color coats and four sealing and top coats. The shading coat being applied here is combined with light detail sanding to provide a uniform appearance.



Fig. 11
Lacquer coat gives the cabinet a glossy appearance. The "waterfall" at right keeps fumes away from operators.



Fig. 12
Final "white wood" cabinet is shown.

hand sanding, full finishing, trim (decorative hardware), rub, and packing operations.

The puzzle of producing RCA color television console cabinets is a welcome challenge to 1000 people at the Monticello, Indiana manufacturing plant. The employees at the Monticello

location share a common goal of improving the plant's (puzzle producing) performance. The goal and the puzzle are captured in the portrait of excellence seen in a wood television console cabinet from RCA.

Woodworkers we are, and this is how we feel about our craft. "You can look

at many products, search for the best, and there is no doubt in our minds that you will see working with wood has a greatness above the rest. God intended it that way when He made the tree."

Reprint RE-24 4-3

Final manuscript received August 10, 1978.

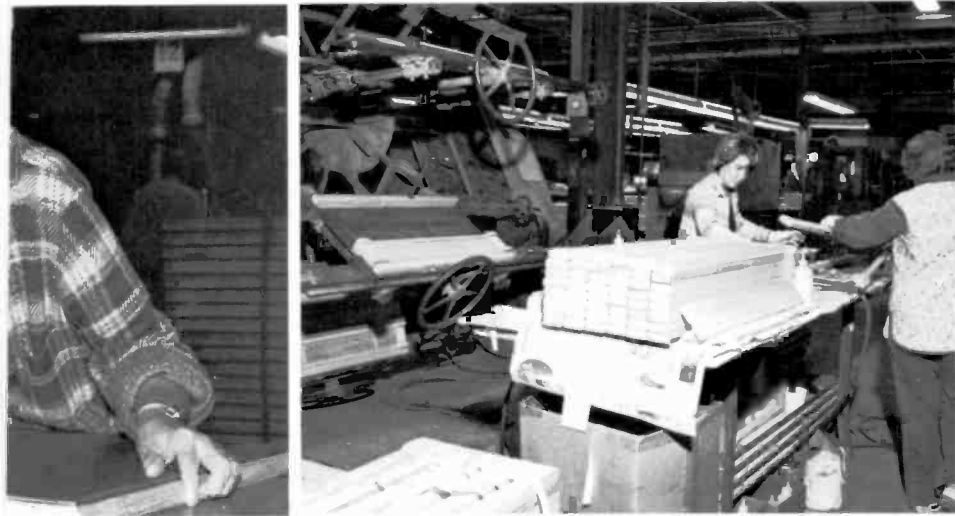

Fig. 7
Gluing-up takes place on this "wheel" fixture. The front mouldings are assembled and glued at the right, then placed in the wheel clamping fixture. By the time the wheel rotates one full turn, the glue has set up and the finished piece is ready to be replaced by a new one ready for clamping.



Fig. 8
The layup operation sees all the detail parts and assemblies come together. A furniture-type cabinet requires proper gluing and doweling before automatic nailers and screwdrivers are used to hold the multiple assemblies together.



"ool and wax" rubbing puts the n showroom shape.



Fig. 13
Ready to go. The fully finished wood cabinet is now ready for packing and shipping to RCA's final assembly plant at Bloomington, Ind.



Audie Bowman is Manager of Manufacturing at RCA's cabinet plant at Monticello, Ind. He has 32 years of experience with RCA, 10 in his present position and another 10 as Manager of Manufacturing Engineerig

Contact him at:
Manufacturing, Consumer Electronics,
Monticello, Ind. Ext. 205

Design to production: preparing the manufacturing process

R.D. Orman|A.M. Tinsley

Manufacturing on an assembly line requires a step-by-step "recipe"—the process. Without it, simultaneous quality and quantity production would be impossible.

Ron Orman has worked in all phases of manufacturing engineering since joining RCA in 1967. He has been a Timestudy engineer for Instrument Assembly, developing standards for final assembly and indirect labor, and has had wide experience in processing color television instruments from sub-assembly to the pack section. As Manufacturing Methods Engineer, he currently has the process responsibility for the chassis assembly area of the final assembly plant.

Contact him at:
Manufacturing Engineering
Consumer Electronics
Bloomington, Ind.
Ext. 5381

Al Tinsley is presently manager of the Printed Circuit and Chassis Process Group and is involved with assembly process writing, tooling design, and facilities procurement and utilization. He has experience in various phases of manufacturing engineering, including a broad background in the control of overhead costs, and was manager of the Indirect Labor Studies and Plant Layout Group for seven years.

Contact him at:
Manufacturing Engineering
Consumer Electronics
Bloomington, Ind.
Ext. 5374

Reprint RE-24-4-6|Final manuscript received July 7, 1978.

Ron Orman (left), **Al Tinsley**, and CTC-92A color tv chassis.



The manufacturing process is much like a cookbook; it gives the step-by-step procedure for assembling a given product, a color television receiver. Like the list of ingredients of a recipe, the process gives the quantity and description of all the parts required for a specific model and the order in which they are to be assembled. Certain parts must be assembled in a specific sequence because of their mechanical and/or electrical properties, and other parts can be assembled in an infinite number of sequences; the manufacturing process specifies the order. The process also specifies the type of equipment required to assemble the parts—equipment that might vary from an ordinary screwdriver to a piece of very sophisticated automatic equipment. The end product of a recipe can only be achieved if a cooking time and temperature is given; correspondingly, the process must give the time and labor classifications required to make the assembly.

Once all of the above items have been determined and actually specified in the written form of a manufacturing process, samples must be built to assure that the end product meets all of the expectations and specifications set forth for the model. During the sample build or even after the model starts in production, it may become necessary to change the process because of a design change, a better assembly method, or other unpredictable circumstances. With each of these changes, regardless of complexity, the whole procedure of developing the process must be repeated.

Who prepares the process?

The Manufacturing Engineering department of each Consumer Electronics facility is responsible for preparing the process,

which means they must determine the labor requirements, space requirements, assembly rates, assembly machines and tools, test equipment, and production facilities. The preparation of the process begins with the Manufacturing Review meetings, progresses through analysis of an Engineering performance sample, continues through factory builds of pilot and preproduction samples, and culminates in production. The completed production process cannot be viewed as a static system, but rather as a dynamic entity, responding to the need for both cost and performance improvements, frequently instantaneously.

Manufacturing Review Meetings are held nearly a year prior to production. These meetings are extremely important, as they give manufacturing engineers their initial opportunity to review and evaluate the relationship of the proposed design to the process and efficient manufacture of the product. Examples of review meeting topics are: printed-circuit-board layout, board solderability, chassis-to-accessory connections, and other mechanical or electrical items that could affect the completed process.

What's behind the process?

The process provides the manufacturing function with the sequence in which to

assemble the television, the number of operators required, the drawing and part numbers of each part required, the tools and fixtures required; and the feasible number of sets to be built per hour.

The first step in the creation of the process is the development of the best sequence for assembling parts for that particular model.

At this time, each part or group of parts is evaluated for the feasibility of using automatic assembly equipment, special holding fixtures, or assembly hand tools. This evaluation leads to the ordering of production equipment and tooling. An example of a group of parts that has been automatically subassembled is the wing screw, lock washer, bracket, and fiber washer (yoke wing bracket assembly) shown in Fig. 1. Because equipment needed for this type of assembly is complex, it must be designed and ordered at the earliest possible date after the design has been released. For example, the equipment shown in Fig. 2 was installed to support production nine months after the conception of the idea of automatically assembling the yoke wing bracket assembly. On the other hand, a very simple holding fixture can be designed and ordered only two weeks before production. The same type of analysis also applies to the electrical test equipment requirements of the model.

The next step in the development of the process is the building of a small quantity of the new model, called a pilot sample.

These samples provide the first opportunity to check out the sequence process and the design of mass-produced parts. However, the major purpose of the sample build is to establish that the design can be built in a mass-production facility using a continuous-flow system. All problems that develop during this sample build, either with design, assembly method, or material, are reported to Design Engineering in writing. After the problems have been analyzed by all responsible departments, a review meeting is held to resolve or establish acceptable solutions for all known problems.

Based on the pilot sample experience, the assembly and test processes are further developed by dividing the sequence operations into the smallest complete work elements.

For example, in the first sequence process one portion of work might be to "pick up chassis from table and assemble in the cabinet using two screws." However, in writing the detailed process (Fig. 3), the same work might be divided into six elements of work: 1) pick up chassis from table; 2) assemble chassis in cabinet; 3) pick

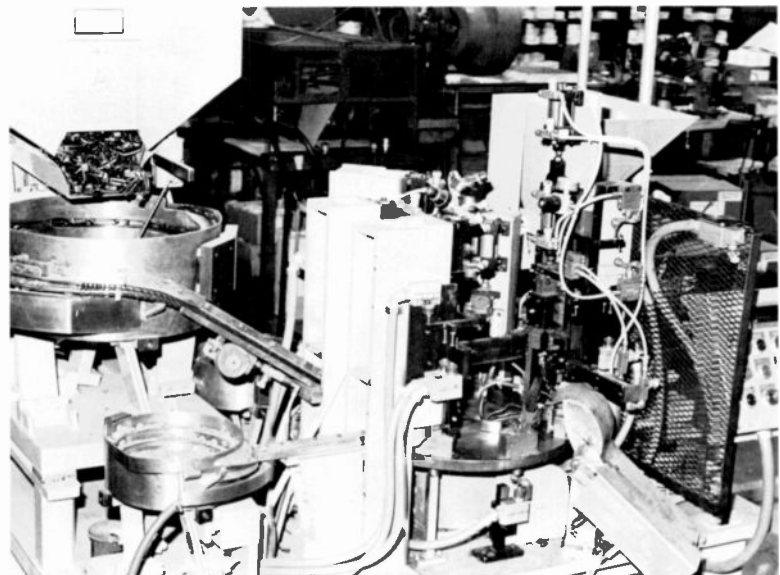
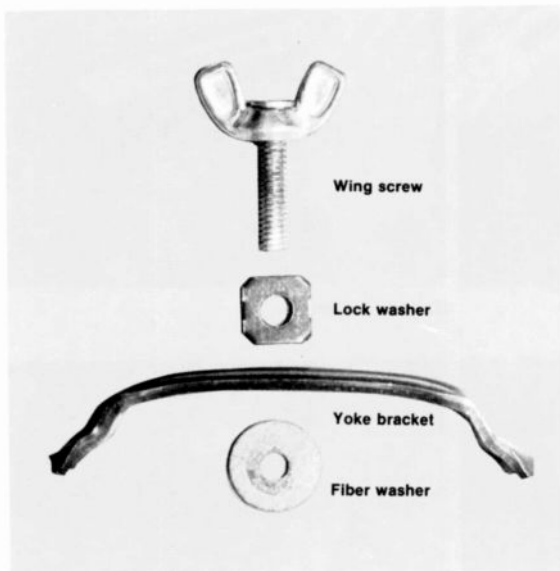

Fig. 1
Is automatic assembly possible? Engineers must examine each group of parts to determine the best method of assembly—hand, semiautomatic, or automatic. This group of parts, the yoke wing bracket assembly, is put together by the automatic machinery shown in Fig. 2.

Fig. 2
Automatic machinery assembles 1200 yoke wing bracket assemblies per hour. Parts feeders are at left; assembly takes place at right. Advance planning is important because engineers need long lead times to design and/or order such machinery.

ST 852 A

DL		Model GC615, 618, 625, 628, 635, 638, 678, 688, 744, 748, 938				Part Name Chassis		Oper No 6	Sheet 9
Ref No		Version	Pro Engr RDO	Date 3-13-78	T S Engr	Date	Rate 103-108	Line Bal .528	
Oper Code		Oper Class Tools, Fixtures & Equip Pistol grip airgun at 20 in-lbs				PRELIM. BLOOMINGTON			
Item	Qty.	Ref. Drwg. No.	Description of Part	Description of Operation	Setup Time				
A		(from plant 1) 1466390-602	VTCA2B	Pick up chassis	030				
B				Assemble chassis in cabinet	192				
C		1444292-13	.62 Hex Hd	Pick up airgun and two screws	028				
D				Drive first screw	105				
E				Drive second screw	105				
F				Put down airgun	016				
G									
H									

Fig. 3
The manufacturing process (above) is the recipe for each step of assembly (right). It tells the sequence of the assembly operation, the number of operators required, the part numbers required and where they are required, the tools and fixtures required, and the number of sets that it is feasible to build per hour. This sheet is for one step of the process—assembling the chassis to the cabinet; note how it matches the actual process. (This is not an actual process sheet, but one made up for the purpose of demonstration only.)



Operator picks up chassis,



assembles chassis in cabinet,

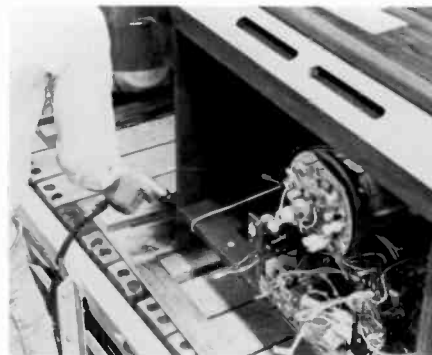

picks up airgun and screws,



drives first screw,



drives second screw, and



puts down airgun.

up airgun and simultaneously pick up two screws; 4) assemble one screw to airgun and drive to secure chassis to cabinet; 5) assemble second screw to airgun and drive to secure chassis to cabinet; and 6) put down airgun. These work elements are then assigned times in which it is expected that an average operator possessing good skill and exerting good effort will be able to complete that part of the job.

This time can be determined in a number of ways developed by the Timestudy group. The easiest method consists of checking the "Standard Data" to see if a specific standard time has been established for this element of work. If there is no specific standard, the time might be developed from the general timestudy data. The chassis assembly mentioned above, for example, might not be listed as such, but there might be general data for picking up an object of a specific size and weight, moving it so many inches, and assembling it to two pins. If it is not possible to develop a time from either specific or general data, the time can be assigned using the "Work Factor," a predetermined motion/time system. In order to establish a time under this system, each element must be further divided into basic manual motions and mental processes. If it is not possible to establish a time using one of the three methods described, then stopwatch time is used.

The process gives line speed and the amount of work required for each operator.

The number of completed television sets required per shift is established by the Scheduling Department. Once this rate is known, a production rate is figured that takes into account allowances for downtime (break and clean-up time). The Bloomington Plant has two 10-minute breaks during each shift and four minutes for cleanup at the end of the shift. Out of a 480-minute shift, then, there are 456 minutes of actual work time. Therefore, the required average production rate per shift must be multiplied by 1.053 (= 480/456) to determine the full hourly "running" rate. For example, if the desired production per shift is 800 sets, the average rate would be 100 sets per hour (or 10 hours per 1000 sets), and the running rate would be 105.3 sets per hour.

Once the overall line rates are known, the time available to the individual operators, or "select time," can be calculated. To do this, we must allow for fatigue (5%),

personal time (5%), and unavoidable delays (2%), as for discrepant parts. These times add up to 12%, making the formula:

$$\text{hrs} = \text{select time} \left(\frac{\text{min}}{\text{set}} \right) \times \left[\frac{1 \text{ hr}}{60 \text{ min}} \times 1000 \text{ sets} \times \frac{100\%}{(100-12)\%} \right]$$

The quantity in the brackets, called the rate multiplier, equals 18.94 in this case, reducing the equation to:

$$\text{hrs} = \text{select time (min/set)} [18.94]$$

For our example of making 1000 sets in 10 hours, this gives the select time as 10/18.94, or 0.528 minute. In the continuous-flow system used at Bloomington, the television sets move past each operator at a constant rate. The work assigned to each operator must then not exceed the select time (0.528 minute per set in our example). If every operator has exactly this amount of work, we have "line balance." The total sequence of work needed to be done is then divided into sections that are equal to or less than line balance, thus determining the number of operators needed.

The assembly line

Currently the Bloomington assembly plant uses a continuous-flow system from the point where the cabinets are unpacked to the point where the finished goods accumulate for warehousing.

The production line starts in a basement area where the cabinets are unpacked and loaded onto a two-tier elevator, cabinet on the bottom, carton on the top. The elevator takes these items upstairs and automatically unloads the carton onto a belt conveyor that conveys it to the back of the instrument line for the eventual packing of the finished instrument. At the same time, the cabinet is unloaded onto a 36-inch wide wood slat conveyor. This conveyor is mounted 24 inches high in a "pit" with space for operators on each side (Fig. 4).

Two overhead monorail systems deliver the picture tubes and chassis to the line at their points of assembly. Farther along the slat conveyor is the area used for testing, electrically adjusting, and aligning the televisions. After the back cover is added, the completed instrument moves through another area for a complete quality check and a final consumer safety check. Finally,

the instrument is picked up from the slat conveyor with a vacuum lift, packed into a carton that was delivered to this position on the line by the overhead conveyor, automatically moved down an elevator, and transported by a powered roller conveyor system to the warehouse. For a complete description of the Bloomington assembly lines, see the article in this issue by Apple, Laskaris, and Veit. The important fact to keep in mind is that the manufacturing engineers must design the process *around* these existing lines.

Before a new model goes into production, engineers must make a line layout for that model showing where each operator fits into the physical layout just described.

Then, individual layouts of each work station layout are made, showing the loca-



Fig. 4 Typical production line for color tv receivers. The continuously moving wooden slat conveyor carries the work-in-process instrument past the operators, while an overhead belt conveyor (not shown) transports the empty cartons to the end of the line. The monorail conveyor in the left background is delivering chassis to their required assembly position. Manufacturing engineers must design processes around the existing lines.

tion of the operator, slat conveyor, material, and tools and fixtures, plus the requirements for electrical power and test signals.

Approximately six weeks after the first pilot sample building, the second "preproduction" sample building program begins.

These samples are built on a special line that allows the engineers to evaluate the process operator by operator and check out tooling and handling equipment using material from production tooling. The correct lengths of leads on parts such as resistors and capacitors are checked at this time so that they can be automatically cut and formed for production. This evaluation also applies to wire lengths and the amount of insulation to be stripped from each end of the wires.

All the problems found in pilot samples are reviewed very carefully to verify that they have been solved. During the preproduction build, everyone attempts to anticipate all possible production problems. The resident engineering and quality departments each examine a completed preproduction sample to make sure that all the correct

parts have been used, that the parts are correctly assembled, and that the model meets all specifications established for it. After this evaluation, a production release states any discrepancies found on the sample submitted.

A summary, called a paycard, shows the number of operators and running hours required to manufacture each thousand sets of the model. The paycard is used for determining the manufacturing cost of the model and also for measuring the efficiency of manufacturing in building the model. For example, if a paycard calls for 60 operators and the manufacturing department uses 65, the department would be 92% efficient.

Setting up the line

Approximately six weeks are allowed between preproduction sample building and production to resolve any problems discovered during the sample builds. The night before production starts, the line is set up according to the layout with the appropriate airgun, solder iron, holding fixtures, and hand tools. (Fig. 5 shows some of the assembly aids used on a typical

line.) At the start of production, one set is moved from one operator to the next so that each operator can be individually instructed in the work to be performed. After all the operators know their operations, the line is started at a slow rate and gradually increased in speed over several days until the running rate is reached.

"Balancing the line" is very important.

After the line has been running at rate for at least two weeks, each operation is studied by the timestudy group. Up to this point, only preliminary work times have been established based on average moving distances and ideal layouts. The running line allows the timestudy group to establish more accurate times using the actual layout, moving distances, and parts supplied by the vendor. With the actual work times known, portions of work can be moved from one operator to another for better work balance among operators. The difference between the amount of time that each operator requires to complete his or her work and the amount of time available (line balance) is the "loss-to-balance," which must be reduced as much as possible to produce the set at the lowest possible cost. As an example of loss-to-balance, assume we have a four-operator process where line balance is 0.528 minute and the timestudied times for these operators are 0.495, 0.480, 0.500, and 0.493 minute. The individual loss-to-balances here would be 0.033, 0.048, 0.028, and 0.035 minute, giving a total loss-to-balance of $0.144/4(0.528)$, or 6.8%.

Conclusion

The development of a manufacturing process has been traced from receiving the engineering sample, through building the pilot and preproduction samples, to the actual start of production. This demonstrates that the process is a carefully defined set of tasks bounded by constraints that are most obvious to the manufacturing engineer. The established methods, the constant need for improvement, and the most important factor in the equation, the operator, all require the finished process to be accurate, precise, and logically formulated. Neither the original process nor changes made after production starts can afford guesswork. The goal of the process is to provide an organized approach to the manufacturing procedure that will produce the world's highest-quality television at the lowest possible cost.

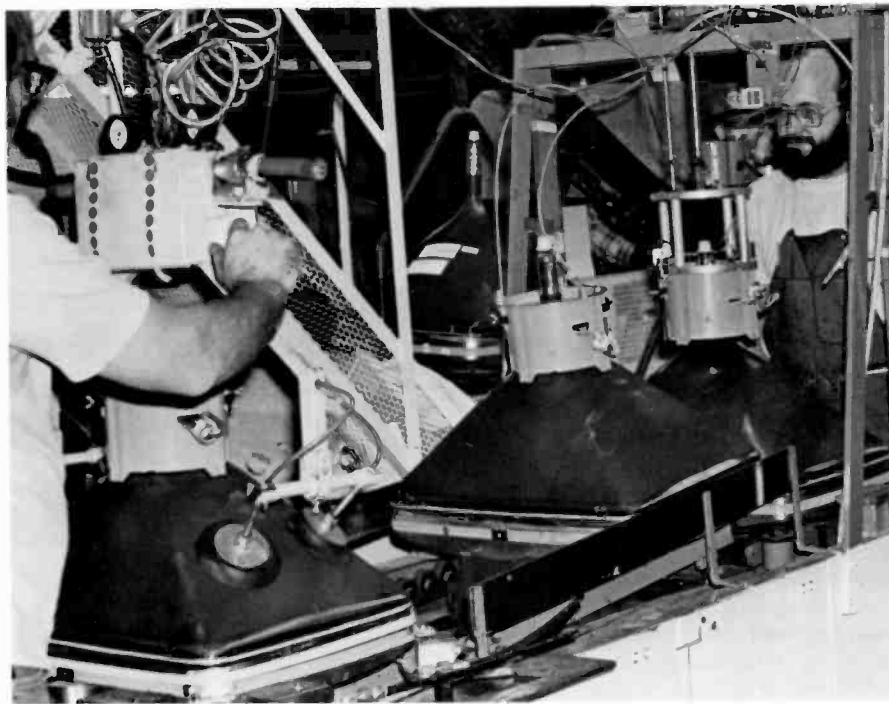

Fig. 5

Line setup requires assembly aids; these two helped eliminate heavy manual labor and reduce operator error. The press shown on the right provides a highly accurate positioning of the yoke and assembles it to the picture tube with uniform pressure, resulting in quality levels that could not be reached with manual assembly. The lift shown on the left reduces the physical effort required to assemble the picture tube to the cabinet.

The ferrite story

Ceramics and magnetism, two of man's earliest discoveries, are combined in the ferrite parts found in today's televisions.

W. Binder



When most of us think of manufacturing electronic components for television sets, the image of white-coated technicians working in clean rooms comes to mind. We probably don't think of 250-ton presses, 20,000-lb capacity blenders, 100-foot-long kilns, and heavy-duty grinding machines, but all of these are part of the ferrite manufacturing process.

What are ferrites and where are they used?

Ferrites are magnetic components made by combining two of man's oldest discoveries, ceramics and magnetism. Specifically, they are defined as inorganic chemical com-

pounds, formed by ceramic techniques from metallic oxides that possess magnetic properties. Televisions, radios, and stereos use ferrite components in many ways—in the deflection yokes that magnetically control the "mad bombardment" of electrons in the picture tube and so create the picture, as cores for transformers, and in coils and chokes. RCA is a leader in the research and manufacturing of ferrites; the photo at the top of this page shows RCA-produced deflection-yoke and transformer cores. Consumer Electronics manufactures great quantities of them "from scratch" at their Indianapolis plant, the only product completely made there from raw material to finished product.

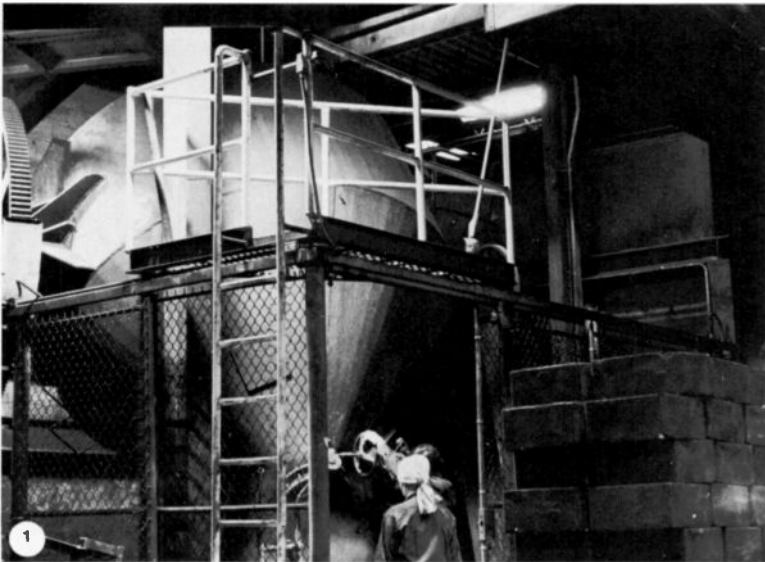

1 Blending. This huge blender takes up to 20,000 pounds of different oxide types and mixes them for hours until they are evenly distributed.

2 First firing. The blend is placed in boxes, put onto small rail cars, and slowly moved through an 1800°F kiln. The process is continuous, with each car making the trip in about 32 hours. This firing binds the different oxide types together. The glow of the kiln is visible between the scale and the rail car.

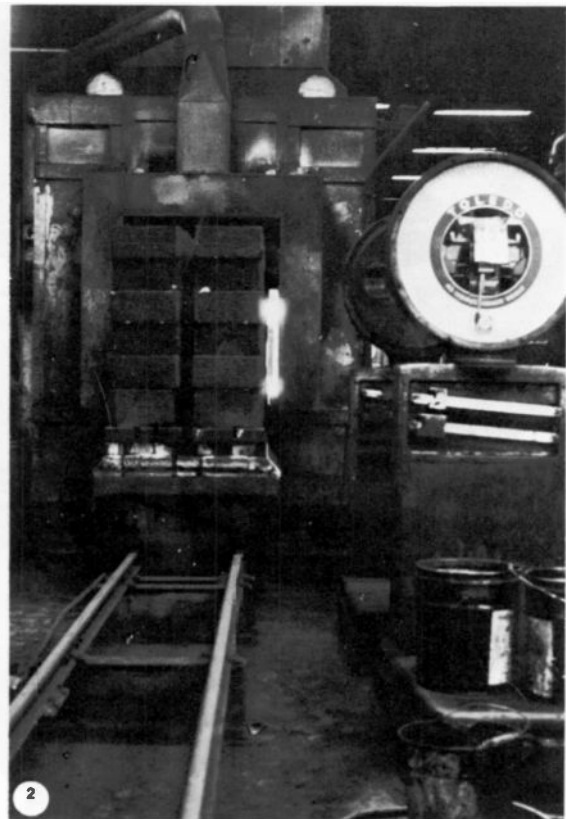



3 Out of the kiln. Worker is removing fired ferrites from boxes. Railcar at right foreground will be refilled for another trip through the kiln; ferrites will get ground to fine particles and dried before the next step of pressing.

4 Pressing. Large (250-ton) presses compact the pellets into the shape of the ferrite piece. Although not at final fired strength, the parts are firm after compacting and can be handled easily. In this photo, the operator is removing a yoke core from the press; the carbide punch is visible slightly above and to the right of the finished core. Parts in foreground have been checked for size and weight and are ready for high-temperature firing.

5 High-temperature firing. Kilns for this operation are roughly 100 feet long; this one extends out of the photograph in both directions. The stacks of transformer cores stored alongside the kiln will take 40 hours to move through it, and will see a maximum temperature of 2300° F.

6 Before and after firing. The yoke core on the right has shrunk 18% over its unfired counterpart. The shrinkage is predictable; the difficult part is controlling it so that the part shrinks evenly in all directions. Other manufacturers must use "shrink blocks" to do this, but RCA has been able to control the process and make them unnecessary.

7 Grinding. Ferrites are quite hard, so grinding can be difficult. This RCA-designed continuous grinder takes yoke cores and grinds them to 0.005-inch tolerances in diameter and flatness.

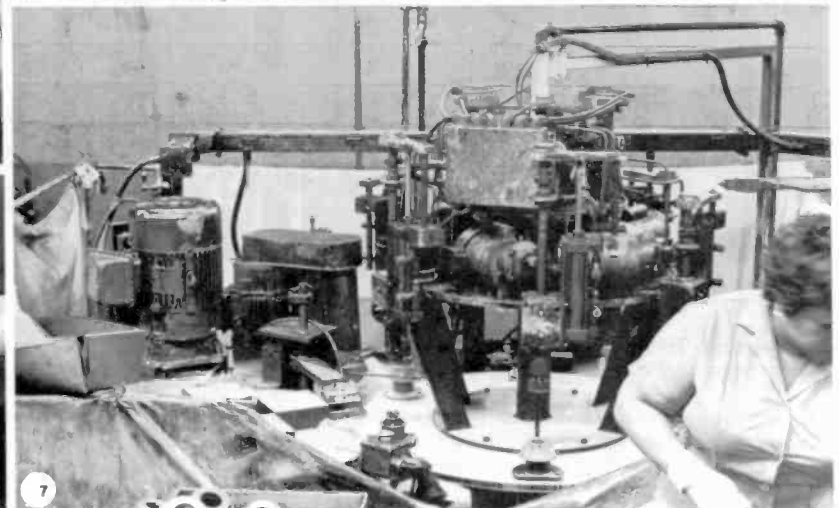
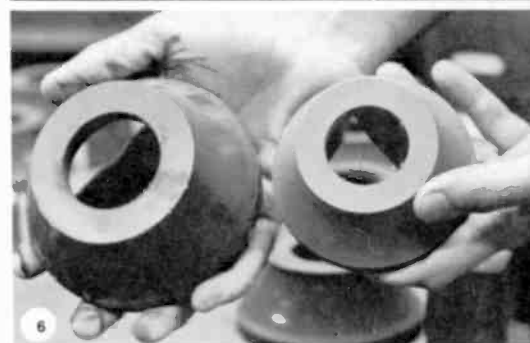
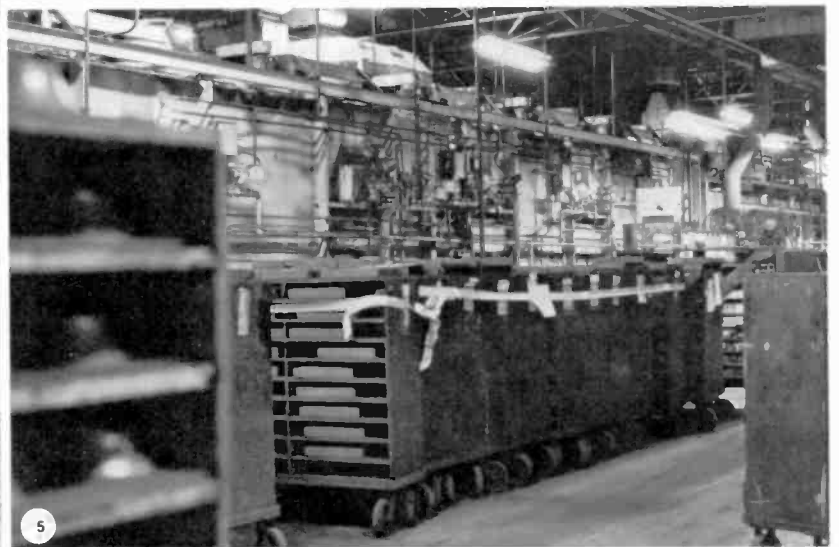

How do you make them?

Ferrite manufacturing at RCA consists of four major steps—processing the powder, compacting it, firing it at high temperature, and machining—each with its own set of substeps. These steps are explained here and in more detail with the photos and captions accompanying this article.

Powder processing. The raw materials for ferrites are metal oxide powders; the specific oxides used depend upon the end products. For example, MnO_2 , Fe_2O_3 , ZnO and CuO are used for deflection yokes, which are gray-black when finished, and Mn_3O_4 , Fe_2O_3 , and ZnO are used for transformer cores, which appear reddish-brown when finished. These mixes are compounded in huge roto-cone blenders (20,000-lb capacity) for several hours. This raw material is then calcined (oxidized) by 1800°F heat in a large kiln, put into a water slurry, and milled down to particles smaller than $4\ \mu m$ (roughly 0.0001 inch) in diameter in 2000-lb capacity ball mills. The oxide slurry is then filtered and has binder added before it is pumped through a spray-dryer, producing the actual fine pellets or agglomerate.

Compacting. Next, high-pressure rams compact the pellets between dies and punches, producing the final shapes for the ferrite parts (but not, as we shall see, the final sizes). The

pressure needed to do this is approximately five to seven tons per square inch.

High firing. The second firing for the ferrite parts is at a higher temperature—2300°F vs. 1800°F. Two types of kilns are used, atmospheric-controlled for transformer cores and open-tunnel for deflection-yoke cores. Each of these kilns, which are roughly 100 feet long, must have tightly-controlled temperatures and times to produce ferrite components that are mechanically and electrically sound. The firing process shrinks components by about 18%; engineers must take this into account and keep the shrinkage even.

Machining. Most ferrite parts must mate closely and accurately with other parts to produce uniform and predictable magnetic properties. (Air gaps have far different permeabilities than the ferrites.) Ferrites are even harder than carbides, so machining is not easy.

The entire ferrite manufacturing process requires great care because of the critical electrical tolerances needed by the parts. The shapes, size, weight, and brittleness of the final parts also mean that quality ferrites require a well-trained and quality-conscious workforce.

Reprint RE-24-4-2

Final manuscript received August 10, 1978.

Wolf Binder joined RCA in 1966 as a ferrite process engineer after other work experience with ferrites and powdered metals. He is now Manager, Manufacturing Engineering, Ferrites, and is also responsible for metal-stamping operations at Indianapolis.

Contact him at:

Ferrites Manufacturing, Consumer Electronics
Indianapolis, Ind. Ext. 5338

Wolf Binder and ferrite in initial and final form.



Finished product. The deflection yoke shown here has undergone many manufacturing steps after the core was made. To make winding the copper wiring possible, the core is broken in half, its two parts kept together, and then put together again after winding. Tight tolerances must be followed to keep the yoke's magnetic field uniform and predictable.

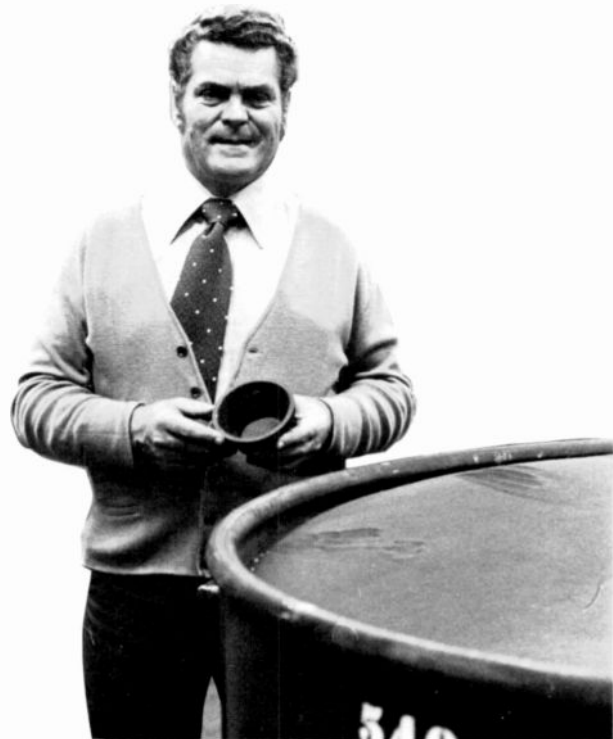



Material flow— components in, finished product out

R.M. Smith|V.E. Adcock|R.R. Hunter

A color television is made up of approximately one thousand parts; getting them into the right place at the right time requires a "lifeline of support"—materials flow.



A color television has approximately one thousand electrical and mechanical parts; the process of getting these parts into the plant and out as a finished product can be called "material flow." The material flow process actually begins to support production as soon as Design Engineering creates the "Bill of Material," or complete listing of component parts specified for the newly designed television model.

When is materials flow important?

Although material flow is continuous from the beginning of the product design development, it has a number of distinct phases:

- tooling and vendor sourcing;

- engineering, merchandising, and manufacturing testing and approval of individual components;

- provision of material for initial factory-built pilot runs for material and performance evaluation;

- provision of pre-production material using only tested and proven parts; and
- production support.

A very close relationship is built between the design engineers and the materials people who establish sources of supply. Exchanging information, testing, approving sample parts, and releasing tooling provides understanding between supplier and user and is really the very beginning of the material flow.

The "Bill of Material" starts it all.

RCA has approximately two hundred color television models in its current production schedule. The Engineering Bills of Material for these models, along with production-plan quantities and timing, provide the base needed for the materials planning system, which projects the total requirement for each component. Complete and detailed procurement plans are made with suppliers for approximately eighteen thousand different component parts to support all manufacturing locations.

The material flow path is established by converting the Engineering Bill of Material into a "Process Bill of Material," which specifies the sequence of the assembly process, enumerates what parts will be used

Where does it all come from?

The components used to put together a color television set come from all over the United States and the world. By the time they reach the final assembly plant at Bloomington, Ind., most of the components have been built up into subassembly form. The major RCA-built subassemblies are built at the following locations:

Wood cabinets	Monticello, Ind.
Plastic cabinets	Indianapolis, Ind.
Picture tubes	Marion, Ind.
Chassis	Juarez, Mexico
Tuners	Taoyuan, Taiwan

Each of these subassemblies, in turn, is composed of component parts from different locations. The picture tube, for example, is assembled at Marion, but uses glass parts from Circleville, O. and electron guns built in Lancaster, Pa. and assembled in Puerto Rico. The chassis, assembled at Juarez, uses printed-circuit boards from Indianapolis and solid-state parts that may come from Findlay, O. or Kuala Lumpur, Malaysia.

in various subassemblies, and indicates where each subassembly will be built. The term "subassembly" refers to an assembly that is used as a part of a larger assembly in the manufacturing process. For instance, a completed printed-circuit board assembly becomes part of a television chassis and the completed television chassis assembly becomes part of the final television instrument. The assembly manufacturing facilities are spread throughout the world, as the box above indicates. Therefore, the Process Bill of Material must be coded for delivery to the correct assembly area within the building facility.

Material Control schedules each component individually for production and makes detailed computerized delivery schedules for each part and each supplier.

Besides scheduling, we also maintain a complete status report on every component at each measuring station along the manufacturing process from start to finish. This close control of the material flow is essential to assure a minimum but adequate inventory at each point of usage, and to support the production plan efficiently with a smooth uninterrupted schedule.

Early support during "sampling" runs

The physical flow of material at the assembly plant level begins with a low-quantity pilot run.

Here, samples of each new chassis type are built for use in design and quality analysis,

plus a 1000-hour reliability life test. All pilot components are inspected and approved by Engineering, although ordering cycles at times make it necessary to use components from temporary tooling.

Pre-production samples are also built on each new model that is to be manufactured.

These samples are built using the specified assembly fixtures, with final assembly process, and with approved components. During component approval, each vendor submits representative samples from final tooling for Engineering, appearance, and manufacturing inspection and testing. One hundred pre-production samples are subjected to a 500-hour life test in the Consumer Acceptance Laboratory (CAL). The pre-production samples are submitted to Engineering, Product Planning, and Quality Control for approval prior to final release for production.

The peak sample period precedes the May Sales Planning Program (SPP) for distributor introduction; however, in recent years, the introductory requirements have expanded to include minor SPP introductions in August, November, and February, so that some level of sample building occurs during every month of the year. The sample building task is quite large—from one to one hundred units each of approximately one hundred and fifteen different television models are built each year.

The computerized Bill of Material, previously referred to, helps in developing

the material requirement lists for each sample model. Component shipments are expedited from suppliers to obtain the necessary approvals and to support the scheduled sample building date. After component approval and the final Engineering release of acceptable pre-production samples, the production support cycle begins and suppliers are notified to begin component shipments.

The data base

The heart of the material control system is the Master Data Base, which is the computerized material record system for Consumer Electronics Division.

This data base essentially consists of material requirements for all models and the complete television production plan, which gives the specific quantities scheduled for each model during weekly time frames. Knowing these inputs gives the component needs for any given production week. In-plant component availability records are updated daily to incorporate new receipts and to record production usage. Individual component requirements are then screened against the in-plant availabilities to produce computer listings of vendor shipping schedules, purchasing followup tabs, and special shortage tabs.

Using predetermined "lead time" codes, the vendor shipping schedules are advanced from one to five weeks ahead of production to allow sufficient time for transit, receipt, and inspection. The Purchasing Department delivers these tabs to each component supplier for use as a delivery schedule. The purchasing followup tabs are used to track the vendor delivery performance. The shortage tab, used for coordinating the production support activity, is a numeric listing of all components not available in sufficient quantity to support the next three weeks' production schedule. Since the requirements are listed by model and by week, proper expediting priorities can be assigned to the Purchasing and Traffic Departments.

"Critically short" items receive special attention.

Material control makes a daily review of each component on the shortage tab and creates a listing of "critically short" items; i.e., any part short of two weeks' production support. In addition to the normal tab data of material availability and requirements by week, the "critical" sheet

also includes vendor shipping information. This is used on the receiving docks to schedule trailer unloading, for expediting shipments through Purchased Material Inspection (PMI) to the production lines, and as an early-warning device for use in physical verification of component availability. Since all component requirements shown in the tabs are based on weekly schedules that are input each Friday, subsequent schedule changes must be manually screened and the resultant shortages added to the daily critical sheet. So updated, this critical sheet becomes Material Control's operating tool for supporting daily production requirements.

The importance of record accuracy can readily be seen. Record validity is audited by physically inventorying components that become critically short—those used on models scheduled for completion within the next four weeks or having a "shrinkage" history. There are approximately four hundred items checked each month and the regular receiving dock verification is supplemented by selective 100% audits of between four to five hundred incoming shipments per month. Additionally, *all* components are counted for record adjustment in the annual plant-wide inventory. Adjustments to requirements and/or availabilities are also made to include Engineering specification changes, outgoing shipments, and rejections. Components made "short" by any record adjustment become a part of the daily critical sheet followup activity.

Following the material through its cycle

The physical flow of material at the production plant starts at the receiving docks.

Three production buildings and one component warehouse in the Bloomington complex have a total of six multiple truck docks and two rail sidings. An average of seventy trailers and seven boxcars arrive daily, bringing in material valued at over \$1,500,000. This inventory consists of approximately ten thousand components received from five hundred suppliers. A fleet of twenty-four trailers and eight radio-dispatched drivers are required to relocate trailers and transfer material among buildings.

Using the critical shortage sheets, previously described, and daily production schedules, priorities are established for unloading incoming shipments. Each ship-

ment unloaded is checked for accuracy and apparent damage. Each verified shipment is identified as to part number, quantity, carrier, and date. Vendor packing lists containing these data are matched to the proper vendor purchase-order cards. Both are then used to keypunch a set of receiving sheets. These data are used as computer input for the daily update of component records and by the accounting function for paying vendor invoices.

Copies of the receipt card accompany the material as it is moved from Receiving to incoming inspection (PMI). All material is inspected to Military Standard 105-D, a statistical sampling plan. Inspection results are recorded and the accepted shipments moved to Good Stores. Discrepant components are transferred to Reject Stores for subsequent disposition. The most critical components, the ones needed urgently to maintain production support, are expedited from Receiving to PMI for immediate inspection and delivered directly to the assembly lines. Any discrepancies noted are corrected prior to use.

Material is transferred from Stores to the production lines as needed. Requirements for each assembly area are determined with the use of short-range production schedules, the assembly processes and the computerized material availability records. Daily reviews are made of the maximum/minimum status, striving for a three-day average supply. The supplies are altered as required by engineering changes, rejections, emergency model changes, substitutions, scrap, etc. For example, all component changes made by Engineering Change Notices are analyzed for "break-in" requirements, which are input into the master data base. New components must be vendor-sourced, ordered, and approved. The actual change in usage must be coordinated with process revisions and Quality notification. If components are displaced, the excesses must be disposed of. Record adjustments are made to insure continued support of the new part.

All physical movements of components are accompanied by record updates. The quantity of each assembly produced is also recorded for computer input. These data, and the incoming receipt cards, are used to provide the daily update of component availability status. As made necessary by schedule changes, model completions, quality problems, and vendor support, audit-type inventories are conducted on

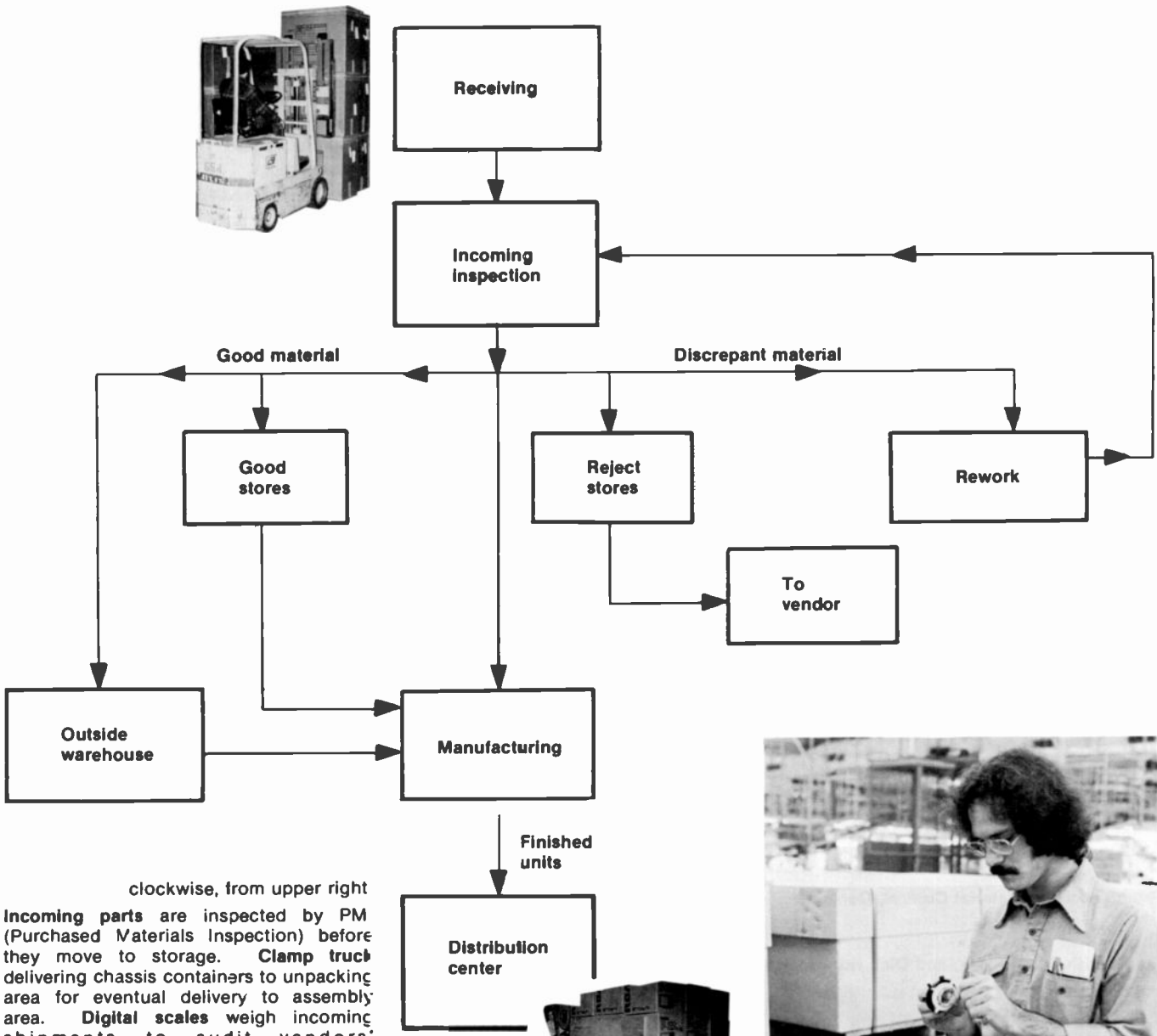

clockwise, from upper right
Incoming parts are inspected by PM (Purchased Materials Inspection) before they move to storage. **Clamp truck** delivering chassis containers to unpacking area for eventual delivery to assembly area. **Digital scales** weigh incoming shipments to audit vendors' statements. **Records review** takes place on video display terminal. The Materials Coordinator uses the keyboard terminal at the left for interrogating the master data base.

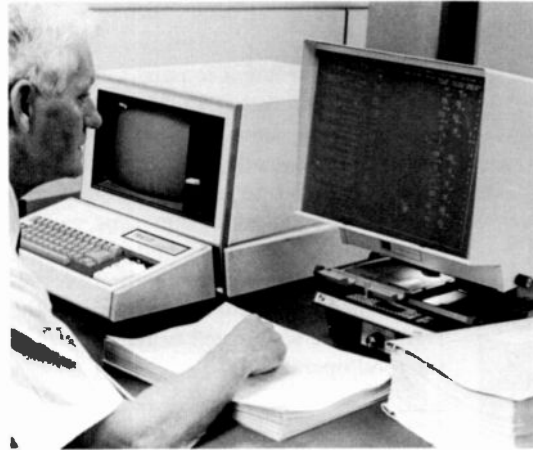

specific components for validation purposes. Production support depends directly upon the reliability of component availability records.

Diversity in component size, configuration, and susceptibility to damage result in a wide variety of material-handling procedures and equipment.

For example, cabinets are unloaded, stored and delivered to the assembly lines with electric clamp trucks; picture tubes are received in palletized containers that are

unloaded and stored via electric fork trucks. The pallet packs are delivered to a central unpacking area for loading onto an overhead monorail system that delivers the tubes to usage points on each instrument line.

Chassis built in our Juarez and Taiwan Plants are received, stored, and delivered to the assembly lines in the same manner as the picture tubes. The packing material in which picture tubes and Juarez-built chassis are received is salvaged and returned to the originating plants for reuse.

Russ Smith, Manager of Plant 1 Production and Material Control, is responsible for the physical materials functions of Receiving, Stores, Floor Material Control, and component preparation. He also directs the activities of the Materials Coordination section, responsible for record maintenance and internal expediting. Russ has been with RCA at Bloomington since 1952; during this time he has worked both as a manufacturing engineer and in materials control.

Contact him at:

Production and Material Control, Consumer Electronics, Bloomington, Ind., Ext. 5340

Vic Adcock joined RCA in 1940 at its then-new consumer electronics operation in Bloomington, Indiana. His experience and responsibilities have centered around production planning and material provision and control; he spent from 1954 to 1961 in the Division's home office in Cherry Hill, N.J. Vic is now Manager of Production Scheduling & Procurement Planning at Bloomington.

Contact him at:

Production Material and Control, Consumer Electronics, Bloomington, Ind., Ext. 5342

Dick Hunter, as Manager, Production and Material Control, is responsible for the correct receipt, storage, distribution, and control of all materials used in Bloomington's Plants 2 and 3, including outside warehousing. He began working for RCA in 1941 as a cleaner, then worked his way up as a storekeeper, leader, and manager in the general area of materials handling and production control.

Contact him at:

Production and Material Control, Consumer Electronics, Bloomington, Ind., Ext. 5463

Russ Smith, Vic Adcock, and Dick Hunter reviewing materials records.



(This recycling operation saved more than \$500,000 in 1977.) Speakers, deflection yokes, printed-circuit modules, tuners, cabinet masks, and other bulk-type materials are received in unitized bulk packs for efficient storage and handling by electric trucks. The plant uses twenty-nine pallet trucks and forty-eight electric fork and clamp trucks to move material in support of the production operation.

Other components, such as screws, knobs, brackets, controls, cables, and electrical devices, are usually packaged in individual containers that must be physically handled throughout the material cycle. Components of this nature are stored in pallet racking and shelf-type bins. The material in the Stores Area is dispersed on a first-in first-out basis to minimize shelf life.

Proper packaging and identification of shipments from suppliers is necessary to reduce handling costs and insure accuracy of receipts. All active suppliers have been issued an "RCA Packaging Guide" that outlines plant requirements.

Conclusion

We have described material flow from the supplier to the points of usage on the assembly lines. This is the lifeline of support that culminates in the completion of roughly eight thousand color instruments each day. The final flow movement is the conveyerized delivery of the completed units to the Finished Goods Warehouse for storage and subsequent shipment to our dealers and distributors. The daily performance is measured and recorded through the use of model serial tickets. The final results are input as a part of the daily computer update which records the performance and adjusts component availability accordingly. The updated records are then used to start the cycle again the following day.

It has been our intent to paint a picture of how the materials operation relates to the production of color television receivers. We hope to have adequately described the system for you to mentally follow the material flow and, at the same time, gain an appreciation for the enormity and complexity of the total system; to have accomplished less would be an injustice to the many people so devoted to the success of the total operation.

Reprint RE-24-4-8

Final manuscript received August 10, 1978.

Conferencing in digital speech communication networks

What's the best way to produce telephone conferences with digital signals? The answer depends on how much complexity can be added to the switching network.

J.R. Richards
W.F. Meeker
A.L. Nelson

In military and commercial speech-communication networks, a conferencing facility that will permit three or more users to converse among themselves is an important requirement. For the most natural conferencing arrangement, any conferee should be able to speak at any time, and any number of the connected conferees should be able to speak simultaneously.

The quality of the system should enable a conferee who is speaking to recognize the voice of another conferee interrupting his conversation. In a conventional telephone network where the speech signal is transmitted in analog form, conferencing can be provided by summing the signal

from all of the conferees and transmitting the summed signal to all conferees. However, because of the delays that may be involved in long distance telephoning, it is desirable to subtract each conferee's own speech from the summed signal. Normal sidetone can be provided locally.

A typical arrangement for an analog conferencing network is shown in Fig. 1. Each balanced input drives a receive amplifier which in turn drives an inverting amplifier and the transmit amplifier for that input port. The inverting amplifier sums all inputs. The result at any transmit amplifier is the summation of the signals from all conferees in one phase with that of corresponding input in the opposite phase, thus cancelling the conferee's own signal in each case.

A trend toward digital speech signals

More and more over the past decade speech signals have been digitized for transmission and processing. There are several reasons for this trend.

- The digital format allows transmission of information over long distances without deterioration since digital signals, unlike analog signals, can be regenerated with a small probability of error.
- Time-division multiplexing of digital data leads to economical use of cables compared with frequency-division multiplexing. No complex filters are required in the digital case since all the multiplexing functions can be readily accomplished with digital logic.
- Switching of digital information can be easily realized with digital building blocks leading to fully automatic electronic exchanges.
- Information in digital form can be easily encrypted. This is especially important whenever privacy or secrecy must be guaranteed—such as in military communications.

Techniques for digital conferencing

Three techniques for the digital conferencing of Continuously Variable Slope Delta (CVSD) Modulated signals are described in this paper, including: (1) CVSD-to-PCM conversion followed by digital summation; (2) CVSD-to-PCM conversion with instant speaker selection; and (3) CVSD activity selection. The digital techniques are compared to the traditional techniques of CVSD-to-analog conversion, analog summation, and analog-to-CVSD conversion. The analog-summation technique was used as a baseline comparison for the three digital techniques.

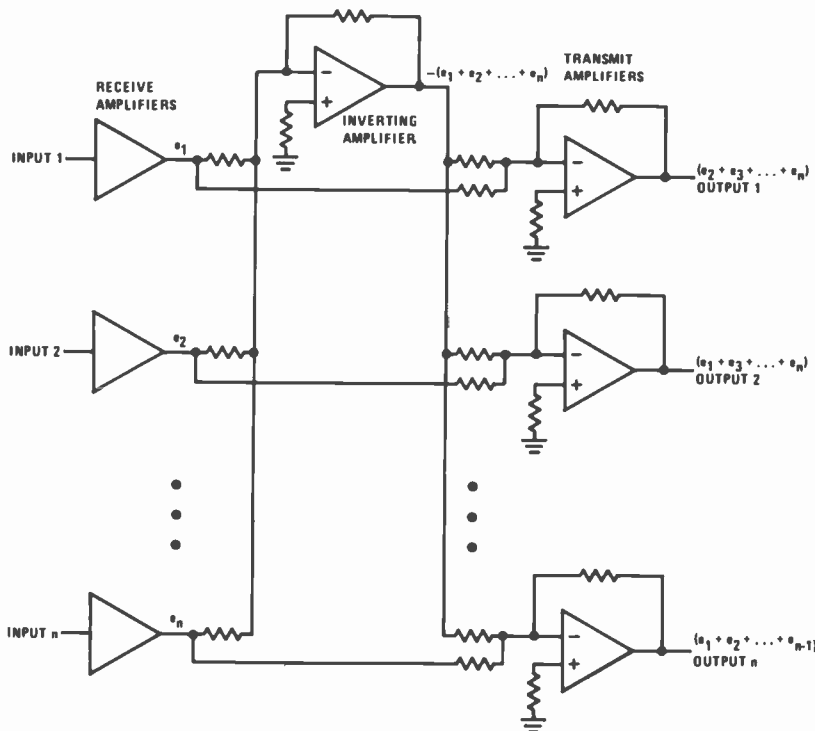

Fig. 1
Analog conferencing network.

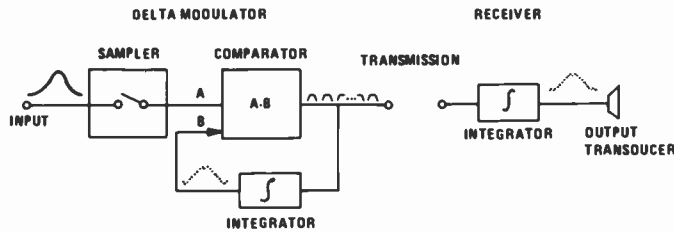

Fig. 2
Block diagram of delta modulation system.

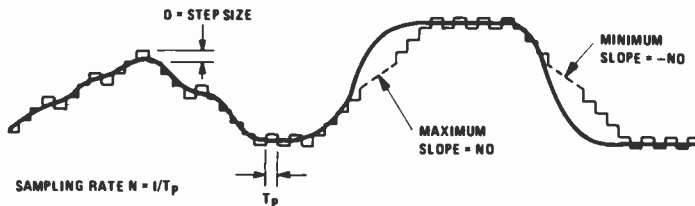

Fig. 3
Input waveform showing its staircase approximation or delta-modulated waveform.

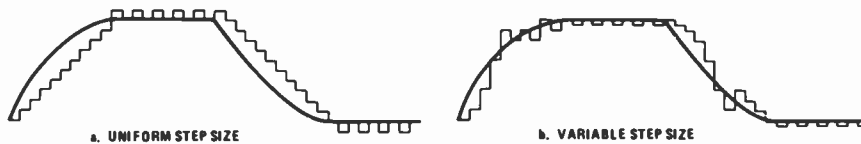

Fig. 4
A variable step size allows the delta modulator to approximate the input waveform more closely.

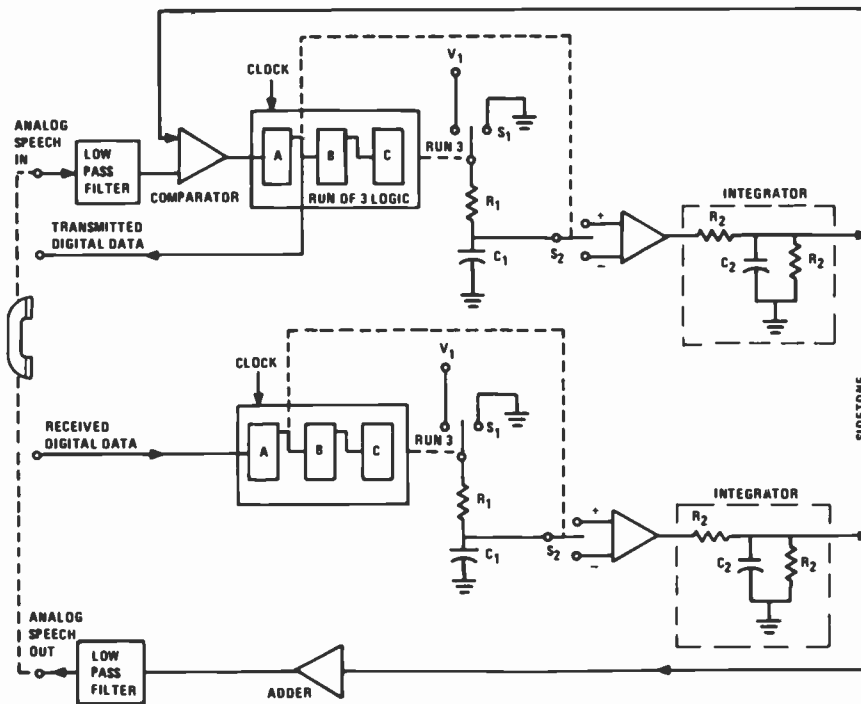

Fig. 5
Digital voice subscriber terminal incorporating continuously variable slope delta modulation. The dotted lines show where logic output controls switches. Switch S_2 is in upper position when logic output is one and in lower position when logic output is zero. The switch position determines whether the voltage across capacitor C_1 is added to or subtracted from the voltage across capacitor C_2 .

Delta modulation

One method of digitizing analog speech is to sample the waveform at regular intervals and code the amplitude of the samples in a digital format. This procedure is called pulse code modulation (PCM). A variation of this method is to compare successive signal samples and transmit only their differences, thus reducing the number of bits required to code the speech. A special form of this latter technique is known as delta modulation.

The principle of delta modulation is shown in Fig. 2. The continuous signal is sampled at periodic intervals in time. The sampled value is then compared with a staircase approximation of the input signal. If the sampled waveform exceeds the staircase approximation, a positive pulse is generated. If the sampled waveform is less than the staircase approximation, a negative pulse is generated. This output pulse (positive or negative) forms the next step in the staircase approximation; i.e., the sum of the binary pulse train at the output of the comparator produces the staircase approximation, or delta-modulated waveform. An important practical feature of delta modulation is that the receiver need be no more complicated than a simple integrator.

Two parameters define the performance of the simple delta modulator shown in Fig. 2, the sampling rate N and the step size D . Fig. 3 shows a typical waveform and its delta-modulated approximation. Ideally, D would be as small as possible and N as large as possible, such that the product DN exceeds the maximum slope of the waveform. For good quality speech, the sampling rate is limited to values between 16 and 32 kb/s, depending on the bandwidth of the communications channel.

Continuously variable slope delta modulation

Many schemes have been developed and tested to continuously vary the step size D (and thus the slope ND) in order to minimize the amplitude distortion caused by quantizing the signal. The Continuously Variable Slope Delta (CVSD) modulation technique used in RCA speech encoders applies the past history of the digital data to vary the charge on an integrator which controls the step size. The charge is in-

creased whenever three consecutive binary values appear at the coder output. Otherwise, the charge on the integrator "leaks" off at a rate determined by the time constant of the integrator. This method is capable of producing a more accurate description of the analog waveform, as illustrated in Fig. 4.

CVSD modulation in a digital voice terminal

A method for performing CVSD modulation in a digital voice terminal is shown in Fig. 5. Incoming analog speech is lowpass filtered at 4000 Hz and compared with the encoded and decoded clock signal at the integrator once each clock period. The output of the comparator is clocked into flip-flop A, which is set to one when the input signal is greater than the integrator output and to zero when it is less. The output of flip-flop A is the CVSD digital signal. In addition to being transmitted, it is clocked through flip-flop B and C at successive clock periods. Whenever there are three successive ones or three successive zeros (run-of-three), a RUN 3 output occurs.

The RUN 3 output controls switch S1, which connects the R_1C_1 circuits to V_1 . If a RUN 3 does not occur, R_1C_1 is connected to ground. Thus, capacitor C_1 is being charged toward V_1 as long as there is a run of three ones or three zeros; otherwise, it is being discharged.

The data bit from flip-flop A also controls switch S2, which determines whether the voltage across capacitor C_1 is added to or subtracted from the voltage across capacitor C_2 (see Fig. 5). Circuit R_2C_2 acts as an integrator (actually a leaky integrator because of R_2). In the actual CVSD circuit, the integrator is implemented with an operational amplifier... the arrangement in Fig. 5 merely illustrates the process.

The voltage on C_1 determines the step size by which the integrator output is incremented or decremented to follow the input speech waveform. The 5-ms time constant, which is roughly equivalent to the duration of a phoneme, results in a nearly linear change in step size over the length of most of the runs of ones or zeros encountered during speech. When there is no run of three, capacitor C_1 discharges, resulting in a smaller and smaller increment or decrement to the integrator output (decreasing the step size). The output of the integrator is an approximation of the speech waveform.

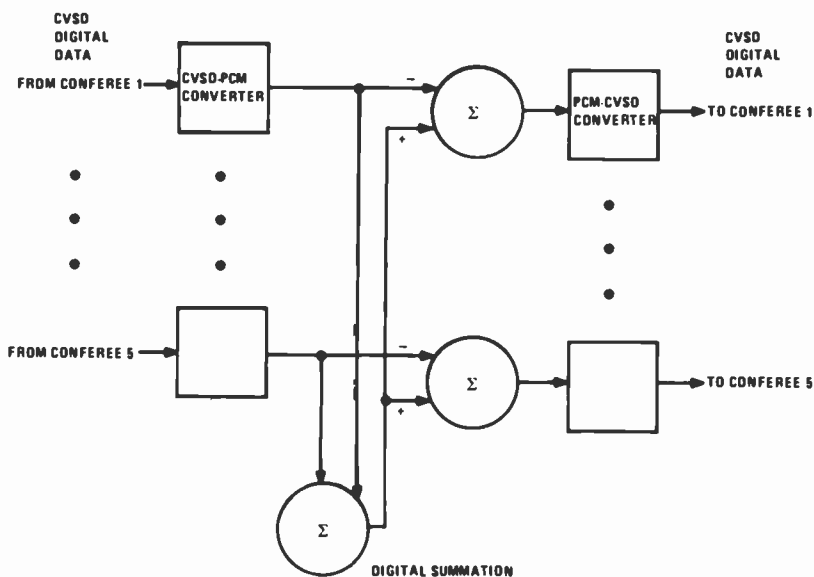

Fig. 6
Diagram showing functions performed by the microprocessor for an all-digital conferencing unit.

Conferencing in a CVSD System

The most obvious approach to conferencing in a CVSD system is to decode all conferees' signals to analog speech, use an analog conferencing bridge, then re-encode the signal to be transmitted to each conferee. However, this approach is undesirable because of the number of decoders and coders required and because there is some loss of quality at each CVSD conversion. Three approaches that do not require conversion to analog speech were evaluated by digital simulation; namely, Digital Summation, Instant Speaker Selection, and Activity Selection.

Digital summation

Digital summation is the digital equivalent of the analog conferencing technique illustrated in Fig. 1. The technique can be implemented using a single 12- or 16-bit microprocessor with the input and output CVSD digital signals being multiplexed to and from the processor. Multiplexing is simplified because all of the CVSD digital signals are controlled by a common system clock. Fig. 6 shows operations within the processor, where the CVSD digital signals are first decoded to PCM, the conferencing network is then formed in the digital domain using the PCM signals, and finally the PCM outputs are encoded to CVSD for output. This approach is called digital summation. (The CVSD decoders and

encoders, as previously described, are implemented within the microprocessor using digital filtering techniques.)

Instant speaker selection

A second approach to digital conferencing consists of first converting the CVSD signal to linear PCM and then applying "instant speaker selection"² to select the CVSD signal on a sample-by-sample decision basis. The instant speaker selection algorithm scans all of the conferees' PCM signals each sample period and selects the line having the highest value. Even if two or three lines are active at once, switching between lines can occur at such a rate (and for such duration) that the resulting signal sounds like a mixed signal, with a small increase in noise occurring because of the switching.

In the instant speaker selection approach to CVSD digital conferencing (see Fig. 7) the digital processor performs the following functions:

- Accepts as input the CVSD digital data from all conferees' lines.
- Decodes each CVSD signal and produces a PCM representation of the speech signal.
- Scans all of the PCM signals each sample time and selects the line having the largest absolute amplitude, designating it the primary speaker.

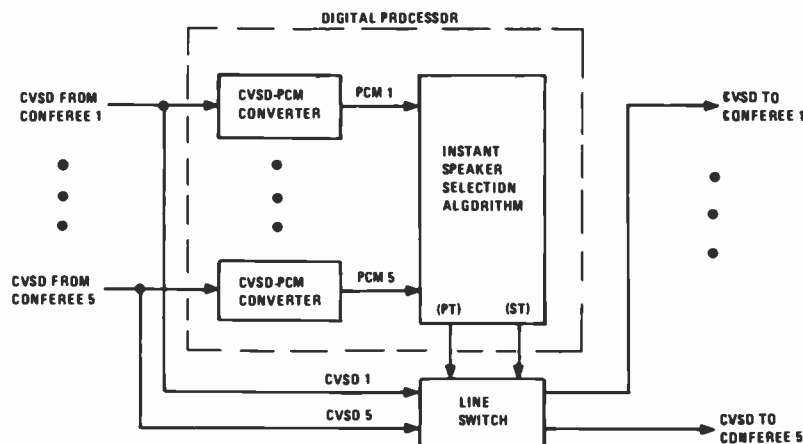

Fig. 7
Instant speaker selection system for CVSD digital conferencing prevents speaker from hearing his own voice.

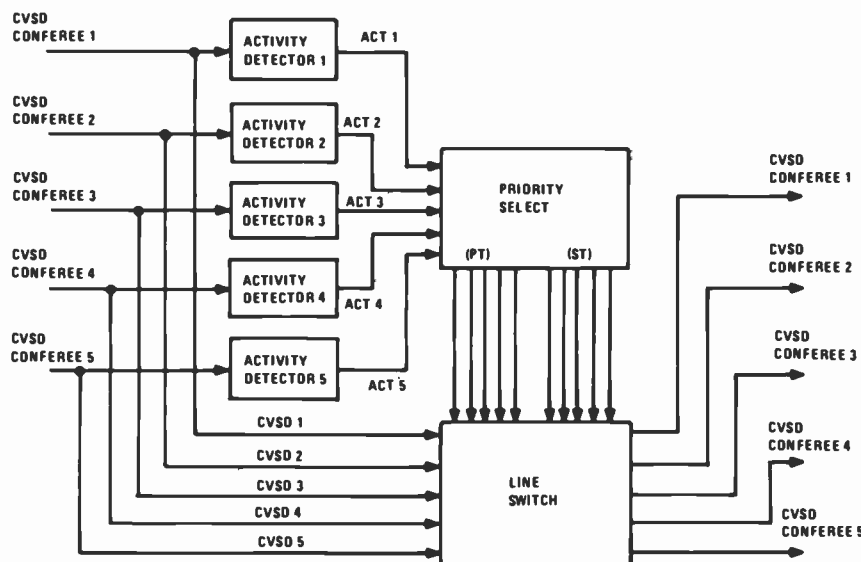

Fig. 8
Activity selection system for CVSD digital conferencing. This system requires that speaker priorities be established.

- Maintains identification of the previous primary speaker (designating him as the secondary speaker).
- Outputs the address (line number) of the primary speaker and the address of the secondary speaker to the switching network.

The switching network has the necessary logic and switching capability to connect the primary speaker's input line to all output lines except that of the primary speaker and to connect the secondary speaker's input line to the primary speaker's output line. This arrangement prevents the primary speaker from hearing

his own voice, but allows him to hear other active lines.

The switching rate is controlled to some extent by the way in which the selection of the largest signal is made. If all of the bits of the PCM signal are used in making the selection of the largest signal, switching will occur often and will introduce excessive noise. By using only the three most significant bits of the 12-bit PCM word, the switching rate for simultaneous speaking is fast enough that no speech is lost and switching noise is not objectionable. Yet, it is slow enough that the listener's CVSD decoder can pick up and follow the speech signal.

Activity selection

A third approach to CVSD digital conferencing is Activity Selection.³ This technique is based on the characteristics of the digital output of a CVSD encoder during intervals of speech input. With no analog input the CVSD output is an alternating series of ones and zeros. With speech input the CVSD encoder generates sequences of ones and zeros, although such sequences will be interspersed with short intervals of alternating ones and zeros. Thus, an indication of an "active" line can be obtained by making some measure of the number of ones or zeros in sequence. Such a measure is conveniently obtained by monitoring the CVSD bit stream and incrementing a four-bit counter whenever the present bit is the same as the preceding bit and decrementing it when they differ. The count is limited to a maximum of 15 and a minimum of zero. When the count is at least 8, the line is considered to be active.

In the activity selection system (Fig. 8), activity detectors are attached to each input line and their outputs go to a priority select network, which has three functions:

1. If two or more lines are active simultaneously, a choice must be made. Hence, some priority must be established. The priority select network selects the active line of highest priority as the primary speaker.
2. Identification of the previous primary speaker (secondary speaker now) is maintained.
3. Identification of both the primary speaker and secondary speaker lines are output to the line switch.

The line switch connects the input line of the primary speaker to all output lines except that of the primary speaker, and connects the input line of the secondary speaker to the output line of the primary speaker. While it would appear that only one speaker can be heard at a time, there are generally enough intervals of alternating ones and zeros occurring during speech that the activity indication will be intermittent. Consequently, two simultaneous speakers can be heard. There is, of course, some noise introduced by the switching.

Conclusions

On the basis of simulations run at Advanced Technology Laboratories, all three

Table 1
Estimated requirements for conferencing techniques. Relative performance quality of each technique is reflected by its order of listing.

Requirements

<i>Conferencing Technique</i>	<i>Material Cost (\$)</i>	<i>Volume (in³)</i>	<i>Weight (oz)</i>	<i>Power</i>
Digital Summation	700	90	27	14 W
Instant Speaker Selection	572	58	18	11 W
Activity Selection	88	16	5	1.2 mW
Analog Summation (Reference)	512	28	8	0.5 W

techniques for digital conferencing of CVSD signals are technically feasible and offer usable solutions to the conferencing problem. The digital summation technique was judged to be essentially equivalent to analog summation in terms of speech quality. The instant speaker selection technique and the activity selection technique introduce a small amount of noise when two or more lines have simultaneous speakers. The activity selection technique degrades faster as the number of simultaneous speakers increases. However, all of the techniques are usable for conferencing.

In addition to the computer simulations, an estimate of system complexity was made for each of the three digital techniques, and for the analog technique for a five-party

conferencing network. Comparing the functional requirements at the conferencing network for the three digital techniques, the digital summation technique requires a CVSD decoder and encoder for each conference line and a PCM summing bridge. The activity selection technique requires a CVSD decoder for each conference line and control for the switching matrix. Since the conferencing network will most likely be located within a network switch, an additional matrix switch for the conferencing will not be necessary. Finally, the instant speaker selection requires an up-down counter, a threshold comparator, and control for the switching matrix. Table 1 provides an estimate of the component costs, volume, weight, and power. The order of the listing indicates the judged quality of the various techniques. It is not

Willard Meeker, a Principal Member of the engineering staff, has researched acoustical devices and communications systems, and has served as audio and acoustical consultant for many programs. Recently he has concentrated on speaker authentication, word recognition, and bandwidth compression, including digital computer simulations of linear predictive coding systems and digital conferencing schemes.

Contact him at:
Advanced Technology Laboratories, Government Systems Div., Camden, N.J. Ext. 222-2897

Jerry Richards is Unit Manager of Speech Processing Group in Advanced Technology Laboratories. Since joining RCA in 1971 he has been involved with applying speech recognition and speech bandwidth compression techniques to advanced communications systems. His current responsibilities are in audio communications, speech bandwidth compression, and speech processing.

Contact him at:
Advanced Technology Laboratories, Government Systems Div., Camden, N.J. Ext. 222-4561

Allan Nelson, a Senior Member of the engineering staff in ATL, has participated in studies of the application of feature-abstraction techniques to speaker recognition and speaker authentication, and in studies of speech synthesis. Currently, he is participating in the development of a speech bandwidth compression system that utilizes LPC techniques and HF modem techniques implemented with an ATMIC microprocessor.

Contact him at:
Advanced Technology Laboratories, Government Systems Div., Camden, N.J. Ext. 222-4573

surprising that the speech quality is directly proportional to the system complexity.

The choice of a particular digital technique depends to some extent on where the conference network is located. If it is located in conjunction with a several hundred line switch, where the conferencing functions could be implemented within the switch's processor, the digital summation technique could be implemented with very little cost impact to the switch. If the conferencing network is located where a processor is not available, then a system tradeoff must be made between cost and desired speech quality. Regardless of which technique is finally chosen, it appears that with the increased demand for digital voice communication in both the military and private sectors, digital conferencing will soon be incorporated in future digital speech communication networks.

Acknowledgment

This work was sponsored by the U.S. Navy as a subtask of the Unit Level Switch Study under Contract N00039-75-C-0053.

References

1. Anderson, A.I.: "Digital Conferencing Units," Quarterly Report on ECOM Contract DAAB07-73-C-0146, (Oct 1973).
2. Pitroda, S.G., Rekiere, B.J., and deLillis, J.: "Simulation of PCM Conferencing Algorithm," GIE Automatic Electric Labs., Inc., conference paper—publication source unknown.
3. Goutmann, M.M.: "Digital Conferencing Units," final report on ECOM contract DAAB07-73-C-0150, (Jun 1974).



Authors Allan Nelson, left, Jerry Richards, and Willard Meeker, seated.

Prototype manufacturing in research and development

E.V. Fitzke

Where do you go when your research program needs five versions of a new picture tube by next Tuesday?

In today's rapidly changing technological and competitive business world, it has become absolutely necessary to minimize the time lapse between the conception of a product and the manufacturing of that product. Such speed has become an extremely important factor for any company if it is to realize the full profit potential from its investment in new technology. At RCA Laboratories in Princeton, literally hundreds of concepts and ideas are generated annually. A screening and selection scheme organizes and narrows down these concepts into specific research and development programs designed to optimize the return on investment in new technology development. Today these R&D programs are very much oriented toward improving products already produced by RCA, extending existing product lines, and producing new and unique products for future markets.

As a result of this product orientation, increasing numbers of R&D programs require prototype equipment and devices to be constructed in the Laboratories, evaluated, modified, and reproduced in the shortest possible time. This must all be done under conditions that allow the scientists and engineers to directly observe and guide the construction of these prototypes in order to avoid costly and time-consuming iterations of product design. It is the charter of my organization, Technological Services, to provide the scientific staff with a pool of resources, consisting of highly skilled technical personnel and specialized equipment, to produce working prototypes of experimental devices.

At the outset, it must be pointed out that Technological Services is only one of a number of resource centers at the Laboratories and is concerned primarily with the construction of devices that

operate in vacuum, systems that require the production of sophisticated artwork, and construction that involves precision processing and "watchmaking" quality assembly. Other associate sections of the Laboratories provide machining, wiring, circuit design, thin film deposition, and mechanical engineering support for the technical staff. This article describes those resources provided by Technological Services.

How it works

Technological Services turns ideas into realities.

Most typically, a member of the Laboratories' technical staff reaches a point in his/her program where it becomes necessary to reduce some design or process to practice. Often, the design of a particular device remains somewhat vague and the only way to prove out the design is to construct the device on a best-effort basis, evaluate the unit, discover its shortcomings, redesign, reconstruct, etc., until the device performs to design specifications.

When this reduction-to-practice phase is reached, the scientist consults with the manager of the appropriate service section and describes the proposed device. Usually some sort of sketch is produced, dimensions and materials decided upon, and a work order is submitted for construction. The task is then assigned to an appropriate individual in Technological Services, who is briefed on the job and instructed to work directly with the person who requested the job. The details of the job are again reviewed and check points are identified where construction should be inspected by the requester.

The technologist then accepts responsibility for completing the job even though it

may be necessary to involve other shops and individuals in the fabrication of the experimental prototype. The unit is then constructed under the direct control of the technologist with the requester having the option of making design changes throughout the course of construction. On completion of the prototype, it is tested by the requester and the design modification cycle continued as necessary. As iterations of a prototype are developed, the same technologist remains assigned to the task in order to ensure continuity in the process.

The group acts as an intermediate step between research and production.

Before a prototype development program begins, the Major Operating Unit (MOU) most likely to eventually produce the device becomes involved to some degree in determining program objectives. During prototype development, both the research personnel involved and key Technological Services people make every effort to familiarize themselves with existing facilities and equipment at that MOU in order to duplicate processes or, in general, use procedures in prototype construction that are compatible with those already used in the MOU. "Looking ahead" in this manner can contribute significantly to a rapid and efficient transfer of technology to manufacturing when that phase of development is reached.

As a program develops and it appears as if technology will indeed be transferred to an MOU, the Manufacturing Systems and Technology Research Laboratory at Princeton will assess the development and become involved as is necessary to insure that the most effective manufacturing process is set in place at the MOU.

The role of Technological Services in prototype manufacturing can therefore be

viewed as an intermediary between the scientific staff and engineering staff, a group that reduces principles to practice, and passes on the resulting technology to manufacturing-oriented individuals who refine the technology and guide it into production.

Individual responsibility means less red tape and the best possible prototype in the shortest time.

The two key factors emphasized in Technological Services are: 1) direct involvement in the research program; and 2) the assignment of clear-cut responsibility for prototype construction.

Direct involvement shortens the communication path between the inventor and technologist, eliminating unnecessary bureaucratic paperwork, lengthy written instructions, and the need for detailed drawings. For the duration of the assignment, the technologist essentially becomes a temporary extension of the research group that requested the prototype and is directly responsible to that group for completing the assignment. Because the technologist oversees all phases of device construction, including ones that may be done in other shops by other people, the prototype will appropriately be inspected and controlled throughout its construction cycle. The responsible technologist tends to develop an overall pride in workmanship and will do everything necessary to produce the best possible finished device in the shortest possible time.

Resources

Our resources consist of equipment, much of it very specialized, and of highly trained technologists who operate that equipment and provide special craft skills where necessary. Table I is a partial list of the equipment and facilities available through Technological Services.

The organization is staffed by fifty-two technologists, with the majority trained in at least two areas of specific expertise. In addition to the staff directly assigned to Technological Services, virtually the entire Laboratories research staff is available to us on a consulting basis should we need to request technical help on a particular problem.

Providing this equipment and manpower as a central resource pool for the entire Laboratories has proven to be a very

Table I

Special equipment and trained technicians are available for a wide range of services.

Color picture tube production equipment	Ultrasonic machining equipment
Class 100 cleanroom	Lens grinding and lapping machines
Gerber coordinatograph	Precision cameras
Digitizing computer system	Integrated circuit bonders
Precision grinding and lapping machinery	H ₂ and vacuum firing furnaces
Completely facilitated glass shop	Exhaust stations
Electronic discharge machining equipment	Electronic test equipment
Vacuum leak detection systems	X-ray crystallography equipment
Etching facilities	Metallography apparatus
Step-and-repeat exposure stations	Processing ovens
Photoresist processing equipment	Electroplating facilities
Photoemulsion processing equipment	Exposure stations
Film coating facilities	PC board processing
Precision assembly tooling	IC packaging equipment
	Optical benches

Table II

Product improvement takes place continuously. These products are constantly being modified and require prototypes for analyzing the benefits of the proposed changes.

Picture tubes	Electron guns
Vidicons	IC artwork drawings
Gas lasers	IC mask sets
Glass vacuum systems	Custom IC substrates
Vacuum tubes	Lenses and optical components
Photomultipliers	Printed circuit boards

flexible and cost-effective means of producing prototype devices.

Services

Services are not limited to prototype construction alone—at times, our assistance may only amount to providing a single special weld on a test instrument. In other cases, we might accept responsibility for constructing only one section of a complicated system. We often provide many identical precision parts which are then incorporated into devices in other parts of the Laboratories. It is not unusual for us to provide a specially skilled technologist to a research group for a limited time in order to avoid that group's having to hire outside help. Most of the work done, however, does follow the pattern of our being asked

to construct a finished working device with a minimum of "red tape" in the shortest possible time. Table II is a sampling of the prototypes we routinely produce; all are in the general category of devices and products which must constantly be improved or technologically advanced.

For "mature" products, it is possible for a scientist to simply request a single component change and expect to have a finished working device, component, or precise drawing delivered to his or her desk.

A rough sketch and a short discussion is all that is normally needed for making small changes in devices or drawings that already exist. For example, it is possible to change a grid spacing on an electron gun and deliver a finished 19-inch picture tube

containing that gun within 48 hours of the request. An electronic device can be exhausted and sealed in a glass envelope in a matter of hours; an integrated circuit mask set, which takes weeks to initially prepare, can be revised in a few days; a custom printed circuit board can be fabricated in a day.

Obviously, the more complicated the change or redesign, the more time it will take to incorporate the change. A constant effort is made, however, to keep the request procedure simple and to expedite the process as much as possible within the limits of our resources. Clearly, once a design is firm in the mind of the scientist, the device must be constructed as rapidly as possible in order to allow the evaluation and reiteration cycle to proceed in the shortest time frame.

"New and different" devices require a whole series of prototypes.

For instance, a researcher, in the course of synthesizing a new compound, may note that the material exhibits some unusual light-emission characteristic. In an effort to beneficially use that characteristic, it is necessary to design some experimental vehicle to demonstrate that the material "works." This may at first require that we construct a crude but simple device containing appropriate sensors and input leads. This unit then allows the researcher to verify the material's behavior under specific conditions, which may lead him/her to design a more sophisticated device to optimize the observed effect.

A second device is then constructed to accommodate the design changes and to verify the optimization of light output. The next iteration may be an attempt to use the new material in a new and unique visual display device, constructed on a scale most convenient to observe the material's behavior under display conditions where perhaps a single line or digit lights up.

If the observed performance justifies further development of a specific optical display device, prototypes of a proposed product are constructed to the degree of sophistication and performance necessary to clearly demonstrate the utility and practicality of the device. Cost estimates and market surveys are made, the device is engineered for manufacturing, technologies are transferred, and the unit is produced for consumption.

The establishment of priorities is the most difficult and critical aspect of prototype development.

A typical development scenario may easily require the construction of dozens of experimental devices and an equal number of prototype "products." The turnaround time for the construction of each version of the device is obviously critical. Similar scenarios on other programs invariably develop as the first proceeds through its phases, and priorities must be established to allow the most promising product to be developed in the shortest possible time.

There is a finite limit on the resources available to the research staff. Only so many parts can be machined by a fixed number of tool and die makers; the number of devices that can be assembled depends on the number of technologists employed at the Laboratories; the digitizing and drawing of IC artwork is limited by the capacity of available computers and machines. The question of which task gets done first is of constant importance.

Most resource sections of the Laboratories work under backlog conditions where there is always more to be done than there are resources to get it done immediately. Technological Services is no exception; its sections must be continuously aware of the program priorities set in the individual research laboratories and apply their resources accordingly. This is not a trivial task and how well it is done determines the overall effectiveness of each resource section.

Summary

A successful prototype development program, therefore, depends first on having an abundance of good ideas, then selecting those with the most promise, applying resources to efficiently construct the prototypes, and applying the knowledge gained in the process to manufacturing the product in quantity.

Prototype manufacturing in research and development is a necessary and dynamic function. The time constraints and quality requirements are severe, but the satisfaction associated with seeing ideas become products is great. New and improved products are the foundation for the Corporation's future, and there is every reason to believe that the Laboratories will continue to make every effort to insure that future.

Emil Fitzke has been Manager of Technological Services at RCA Laboratories since 1975. A former Member of the Technical Staff and Administrator, he has worked in the fields of thermoelectrics, magnetic recording media, and technical administration. In his present position he is responsible for supporting the research staff with a central resource pool of highly skilled technologists and specialized equipment providing the types of technical services described in this article.

Contact him at:
Technological Services
RCA Laboratories
Princeton, N.J.
Ext. 2554

Reprint RE-24-4-13
Final manuscript received November 14, 1978.

Emil Fitzke and prototype picture-tube faceplates.



Equipment development— the vital link

L. Rarig
W.R. Kelly

How does manufacturing keep pace with changing production requirements? In the Picture Tube Division, the answer is a special department to help develop the equipment needed to assure economical manufacturing of quality products.

The rapidly changing, competitive world of color picture tubes requires unique, flexible specialty equipment for manufacturing. This equipment must be compatible with process and human parameters. To meet this requirement, the Picture Tube Division of RCA in Lancaster and Scranton, Pa., and Marion, Ind., has an Equipment Design & Development department. The function of this department is to assist the Division's Manufacturing operations in solving equipment problems and to equip the Division for the future.

To handle the volume of work, ap-

proximately one hundred thirty engineers, designers, draftsmen, secretaries, and administrators are employed in the department. They have backgrounds in various engineering disciplines, physics, and chemistry, and provide the department with expertise in high vacuum technology, fluidics, photochemical etching, electronics, computer technology, etc.

Establishing the need for specialty equipment

Projects for developing new production

equipment originate from various stimuli: problems in manufacturing; the introduction of new tube types; new methods for cost reduction; quality improvements; health and safety considerations; and others.

For example, when Manufacturing perceives a need for a new piece of equipment, it issues an Estimate Request. This request is assigned to the group, within Equipment Design and Development, which has the expertise required. The group receiving the assignment investigates the needs of the Manufacturing Department, setting process parameters based on a combination of a knowledge of present techniques, related fields, and future needs. Information is drawn from personnel of the many Product and Process Development groups in both Engineering and Manufacturing.

Based on this information, an estimate of the cost of the needed equipment is generated. This estimate is submitted to the Manufacturing Facilities group which determines if the change is cost effective. If it is, Facilities submits an Appropriation Request to Management. (This request may go as high as the RCA Board of Directors for approval if the investment is sufficiently large.)

After the request has been approved, Equipment Development proceeds. Operator capabilities are considered, and new processing concepts are sometimes tested. Based on the information gathered during this initial period, a set of specifications is developed. These specifications include the variations from normal operating procedure associated with shutdown of existing processes and start-up of the new equipment.



Bill Kelly joined the Government Service Division of RCA in 1960 and transferred to Lancaster's Equipment Development Department in 1965. Since then, he has been involved in the design of most major equipment groups including welding, equipment controls, test equipment, circuit design, Mini/Micro Computers, automated system design and robotics. Bill is currently Leader Technical Staff, Automation and Computer Systems Group.

Contact him at:
**Picture Tube Division
Lancaster, Pa.
Ext. 3222**



Larry Rarig joined Lancaster's Equipment Development Department in 1976. Since then, he has been involved with mechanical aperture mask etch equipment. Larry is also the 1979 Chairman of the Picture Tube Engineering Excellence Committee.

Contact him at:
**Picture Tube Division
Lancaster, Pa.
Ext. 2634**

Reprint RE-24-4-14
Final manuscript received October 15, 1978.

Make or buy decisions

Equipment used in tube manufacturing is of a specialized nature, usually requiring extensive design and development. To avoid needless expenditure, commercial equipment, if available, is purchased and modified to suit the application.

If the engineer chooses to design the equipment in-house, he "lays out" the basic concept on the drawing board. He then meets with all involved parties from Manufacturing, Product & Process Engineering, and Equipment Development to discuss the approach.

Inevitably some changes are made to the engineer's original layout. When all facets of the design are agreed upon, work proceeds. Components are sized and commercial suppliers picked. A draftsman works with the engineer and develops a full set of drawings from which the equipment will be built. After final approval of the prints by the engineer and his manager and the representatives of the plant for which the equipment is to be fabricated, the job is released for construction and installation.

When the construction is complete, the engineer inspects the equipment for any obvious faults. After passing this inspection, the equipment is finally ready for installation.

If the engineer chooses to purchase commercially available equipment, contacts are made with at least three prospective vendors with the assistance of the Purchasing Department. Occasionally, the scope of the project requires that these vendors visit the location for a first hand inspection of the problem. If a vendor is new to RCA, a trip to his facility to check his capabilities may be in order. Finally a request for quotations is sent to at least three vendors.

Upon receiving "quotes," the engineer chooses which vendor is to receive the job. The price is a major consideration in the selection, but also included are delivery estimates, proximity to Lancaster, and previous business relationships. During the design and construction, the engineer visits the vendor to inspect the quality of the work. He notes, on site, any modifications or improvements that must be made before RCA will accept shipment for delivery.

Getting the bugs out

There is no tube production in Lancaster. Therefore, the equipment development engineer travels to manufacturing facilities in Scranton, Pa; Marion, Ind; Midland, Ont; Puerto Rico; or other world-wide plants to check on the installation and also to debug the equipment. Quite often this occurs over a weekend or plant shutdown, so as not to interrupt production.

When all the bugs are worked out and the manufacturing personnel have taken over, the engineer returns to up-date the drawings in order to show any modifications, and to answer questions such as "can it run 30% faster." Usually during this time there are a few frantic problems, which can sometimes be handled

over the telephone. Other times a quick trip is arranged to diagnose the problem. Eventually, everything settles down and the equipment becomes just another part of the Manufacturing Department.

Industrial robots are one example

When one hears the name **ROBOT**, a mental image is formed to the likeness of a humanoid creature in the minds of most people, even those who are technically oriented. Yet, for the most part, industrial robots (IRs) do not look like people and they cannot approach the capability of a person.

IRs can, however, perform tasks such as picking up an item from a predetermined

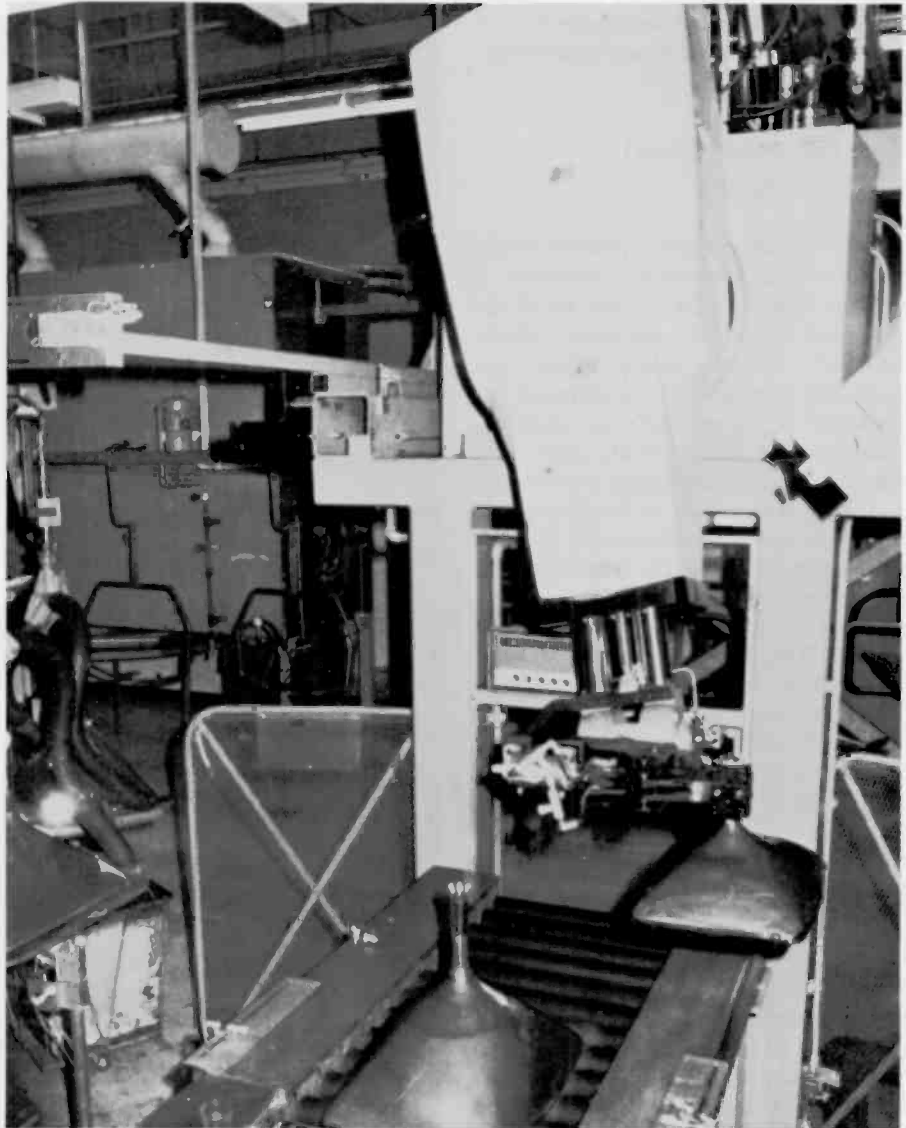

This IR is used to remove picture tube funnels from one of two graphite coating machines and place them on a conveyor for cleaning the seal edge before the application of a glass frit.

place, inspecting it, reorienting it, and placing it elsewhere. IRs can also synchronously track a moving conveyor for picking and/or placing a part and, while tracking, perform milling, polishing, or spraying operations on the part.

By adding sensors to the hand and optical elements of the IR System, much more complicated tasks can be executed. That is the thrust of current efforts: to develop IRs that can perform increasingly more difficult work assignments.

The use of IRs in the Picture Tube Division is practically in its infancy, primarily due to the *systems* complexity of the required transfer task. Only a few production operations incorporate IRs today, but many more applications are in the planning stage for implementation in the near future. The accompanying photographs show various IRs now installed in PTD or currently under development and evaluation.

The IR is only part of the system

An IR is but one element of the total system necessary to successfully automate a specific function. On almost all of the proposed areas for automatic product handling, many modifications are necessary in order to incorporate an IR. Included in these are, for example, rerouting and automatically controlling the feed conveyor; stabilizing the conveyor hanger in preparation for loading or unloading; orienting the tube such that it is presented to the IR in the proper attitude; and providing sensors, such as vacuum switches or mass detectors, for the IR's "hand." Also, inspection devices and sensors must be employed for verification of the tubes' integrity. Last, but certainly not least, a Systems Supervisory Controller must be provided for pacing and controlling all of the elements of the system, including the IR.

Scheduling installation is difficult

Both of our domestic picture tube plants produce tubes on a twenty-four-hour per day basis, five and sometimes six days a week. Consequently, only the weekends are available for installation of the less complicated, less sophisticated automatic transfer systems. For the more difficult and, hence, more time-consuming in-

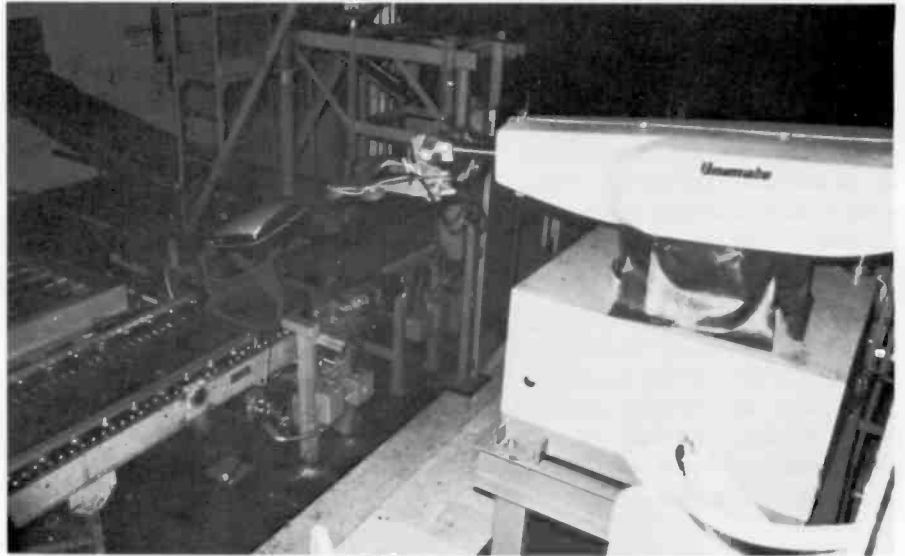

An IR used to unload tubes as they exit from a frit seal lehr and place them on a conveyor hanger for movement to in-line process and test equipment.

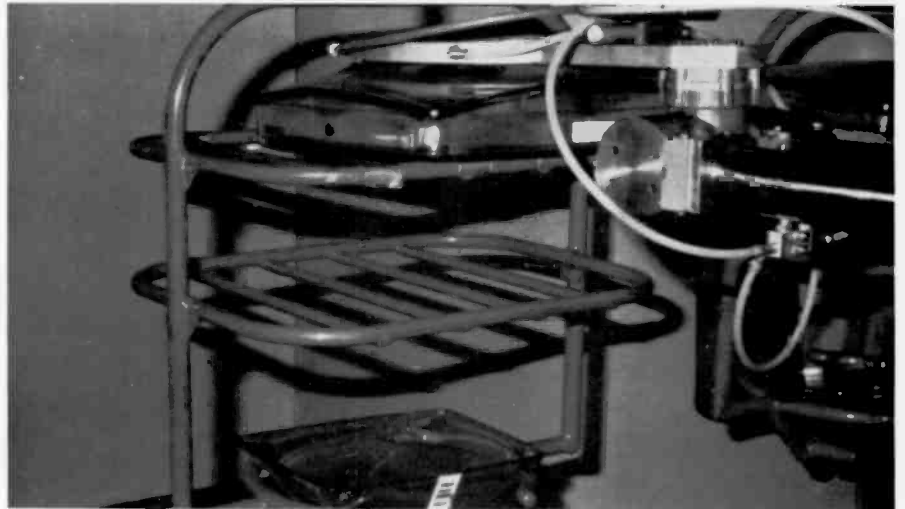

An IR placing a tube cap onto a conveyor hanger.

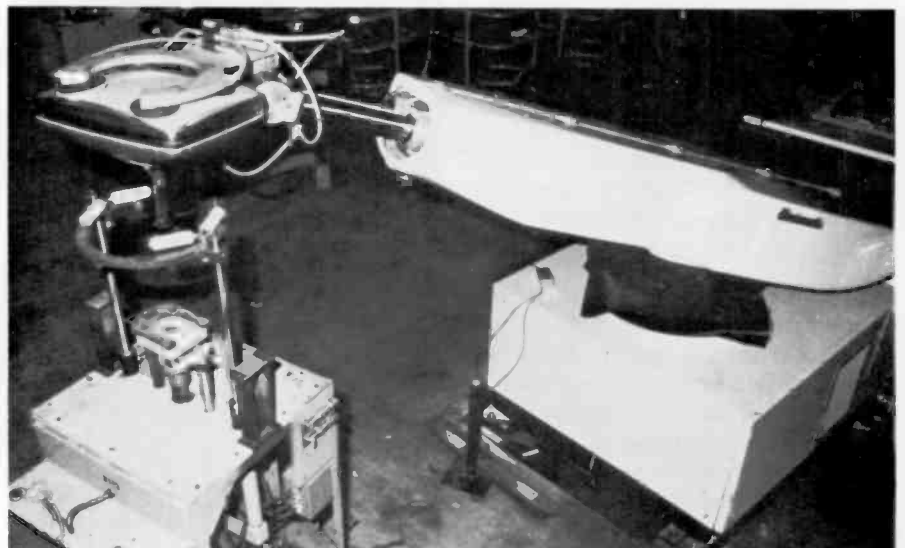

Part of a system under development, this IR is unloading an In-line Exhaust Machine.

stallations, only the two-week plant vacation shut-down is available.

Because of these time constraints placed on the installation of an IR system, much planning is necessary during the conceptual and systems engineering stage. Once the project is budgeted, the most important element of the successful installation is the assigned project engineer. Extensive coordination and liaison work is necessary between Equipment Development, the vendor, and the Plant Engineering Department where the installation is to be made.

The present "Mode of Operation" for a project is to assemble all the parts of the prototype system, mock up the system as thoroughly as possible, and debug it at the Lancaster plant under the direction of the Automation and Mechanization Systems Control Group. By following this procedure, even though it is initially a more lengthy and exhaustive development procedure, time is ultimately saved by ensuring a thoroughly developed and debugged system for installation at the plant during the limited times available.

Some plans for new IRs

Most IRs readily available today have some limitations or disadvantages when we try to use them in PTD plants. These include the cost, size, and complexity of the IR. In an effort to overcome these disadvantages, Equipment Development of Lancaster, in cooperation with various vendors that have demonstrated their capability and expertise in the field, is currently pursuing the design of a new IR.

The IR now being developed will be capable of "tracking" a tube in motion and simultaneously removing it from its captive position or performing an operation upon it. When this new IR is fully developed and available for use, it will enable the Systems Design group to be more effective and efficient in the implementation of IR Systems in the Picture Tube Division facilities.

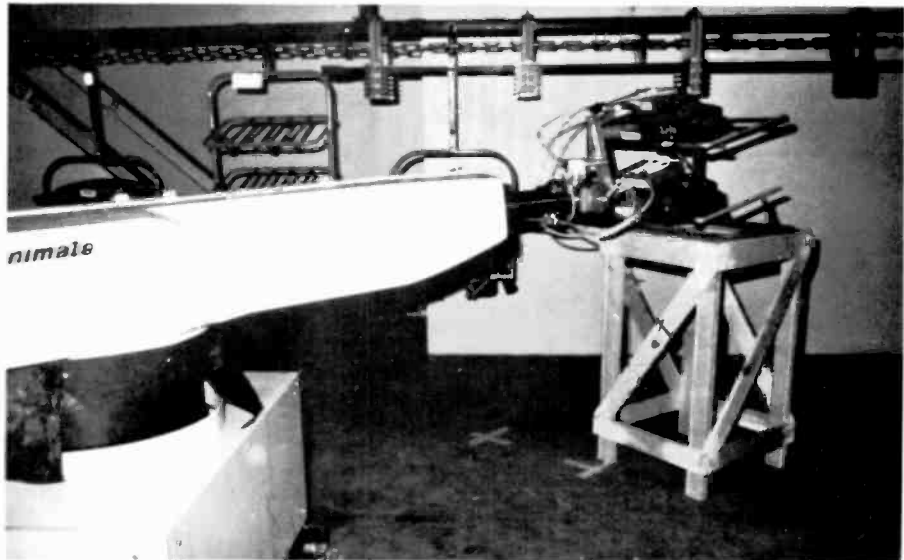

An IR unloading two tube caps from a fixed pick-up point (still in a mocked up status).

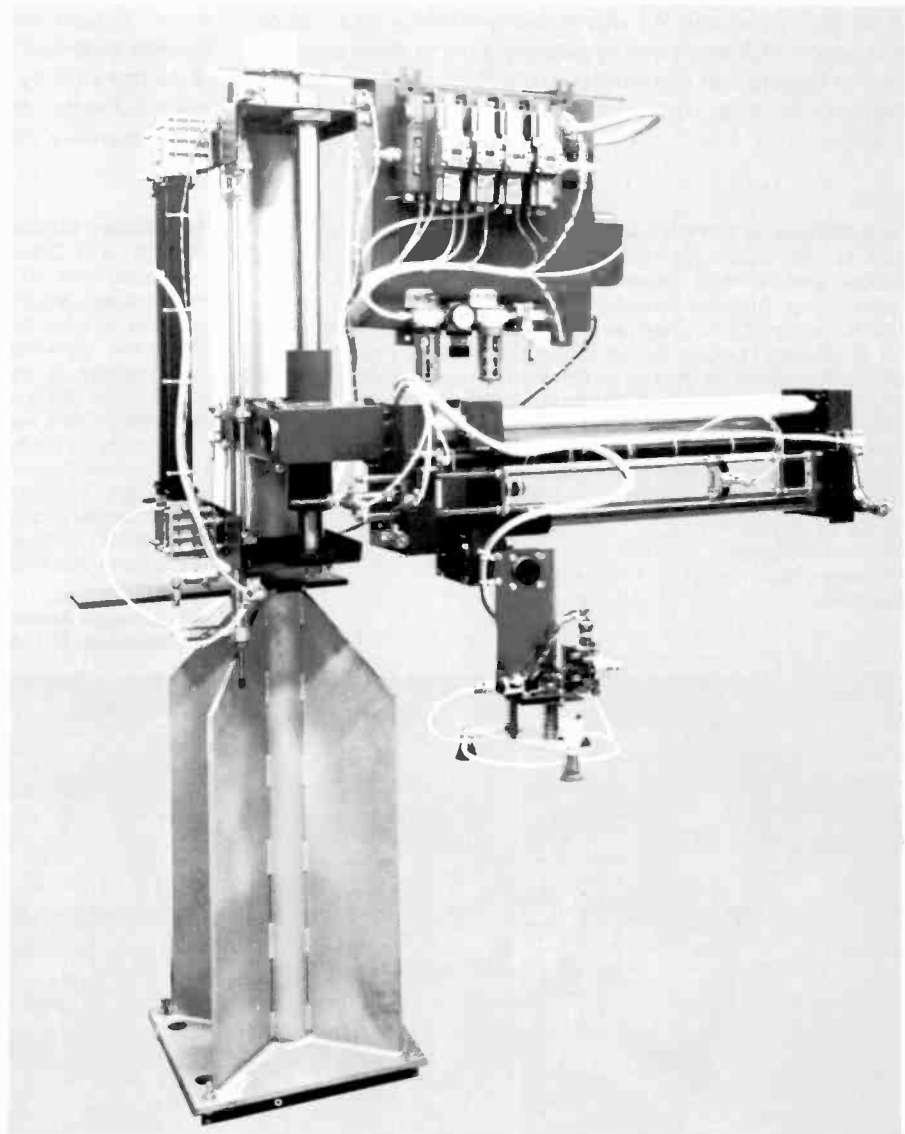

A representative picture of the low-cost transfer device being developed at PTD with cooperation of several industrial robot manufacturers.

on the job/off the job

This is WR2AJC, Princeton, New Jersey

J.C. Hartmann
S.M. Zollers

Hams at the David Sarnoff Research Center in Princeton initially built a 2-meter FM repeater to increase their effective communication range. Today, the David Sarnoff Radio Club with a more powerful repeater station offers a wide range of activities for both the beginning and the experienced hobbyist.

The appeal of ham radio to individuals varies widely. The desire to communicate seems to be the major attraction, but the wish to be an active participant in making something exciting happen (whether it be a contact with a person in a new country or the successful test of a new piece of equipment) is also another powerful motivation. There are, of course, variations of these opportunities for exploration and accomplishment but something akin to them makes a person decide that it is worth the effort of qualifying for the required Federal Communications Commission (FCC) license.

John Hartmann, W2PGI, joined the Astro-Electronics Division of RCA in 1962 where he worked on the Dielectric-Tape Camera, Ranger and Nimbus projects. In 1967 he transferred to the Laboratories Graphic Systems Research group to work on the Videocomp and Color-Scanner projects. In 1970, he became part of the Electronic Printing Group of the Communications Research Laboratory where he worked on terminal printers for Homefax and Videovoice, video signal generators, and LED and inkjet printing. In late 1974, he was transferred to the Display Systems Research Laboratory. In 1978, he received the RCA Laboratories Achievement Award for improved techniques in the fabrication of aperture masks. He has been active in the amateur radio field for many years.

Contact him at:
RCA Laboratories
Princeton, N.J.
Ext. 2349

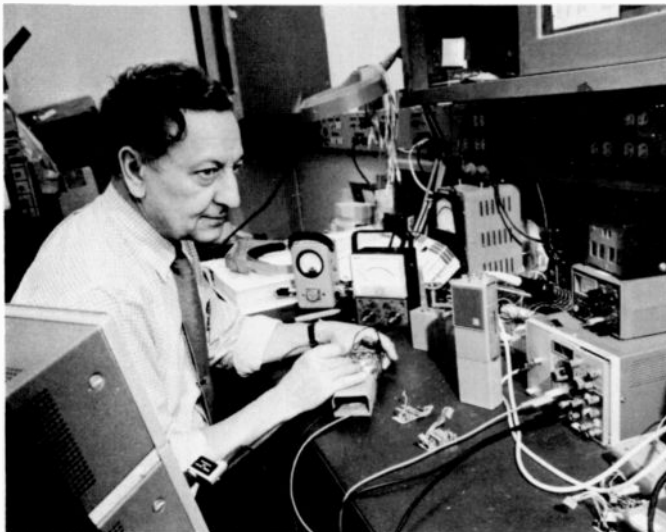

FCC license requirements

One of several classes of licenses is issued only after an applicant has satisfactorily passed tests given by the FCC. These tests demonstrate the applicant's proficiency in using international Morse code and in understanding the rules, regulations, and amateur practice. The class of license obtained depends upon the degree of proficiency demonstrated by the applicant. Being able to copy Morse code at five words per minute and having an understanding of elementary radio theory and amateur radio rules and

Sam Zollers, W2EWN, now retired, joined RCA at its Camden Plant in 1934 as a Drexel Cooperative Student. After graduation, he continued with RCA and worked on electron microscopes and high-voltage structures of the C-Stellarator Ohmic and Ionic Heating System that RCA built for the Forrestal Laboratory of Princeton University. In 1969 he transferred to the RCA Laboratories to participate in the electron beam recording of VideoDiscs. Sam has been a Ham since 1950 and holds an Advanced Class Radio License. He is past-president of the David Sarnoff Radio Club and of the South Jersey Radio Association. He is also a member of the Quarter Century Wireless Association, the American Radio Relay League, and the David Rittenhouse Astronomical Society. Sam presently serves as net control station for a general discussion net and as co-leader for a microprocessor discussion net. Both nets meet weekly on the repeater.

Contact him at:
44 Jefferson Avenue
Haddonfield, N.J. 08033



regulations entitles one to a Novice Class license. The ability to pass a more comprehensive technical test will get you a Technician Class license. Couple this with an ability to copy code at a rate of thirteen words per minute and you will qualify for the General Class license. The highest license obtainable by an amateur is the Extra Class license that requires passing a very comprehensive technical test and handling Morse code at twenty words per minute.

The fact that more than 300,000 stations have been licensed in the Amateur Radio Service is evidence that qualifying is not really very difficult, although some individuals may experience difficulties in certain areas. For some, the code requirement seems most difficult. For others, the legal and technical knowledge required is formidable. This diversity in attitude is paralleled in operating practice too. There are those who look upon Morse code as an obsolete and inefficient means of communications. Other amateurs view code operation as the truest form of amateur communication and look down on those who use more complex means such as microphones, teletype, or tv cameras. At present, the FCC requires that code proficiency be maintained and even offers some incentive for improving this skill by making a greater range of frequencies available to those licensees with the higher classes of licenses.

Even though some hams do develop and use complicated systems, participation in ham radio is by no means limited to persons with prior electronic education or experience. But where electronic expertise exists, hams are likely to be found. It is not surprising that there should be about fifty licensed amateur radio operators at the David Sarnoff Research Center, since RCA Corporation was founded on radio communications as an activity worthy of exploration and exploitation.

Establishment of the David Sarnoff radio club

John Bowker, WA2WEN, who is now Manager, Frequency Bureau, was instrumental in organizing the ham radio club at the DSRC. In December 1974, he circulated a questionnaire to a list of known hams at the DSRC. Forty-two indicated an interest in forming a club. At an organizational meeting on March 6, 1975, Stan Miskowski, K2MEJ, was elected the first President of the David Sarnoff Radio Club. Three classes of membership were established:

Full Member—A licensed Radio Amateur who is also an employee of the David Sarnoff Research Center.

Associate Member—Any active or retired employee of RCA Corporation.

Honorary Member—Membership conferred on a friend of the club by unanimous vote.

From the start, it was recognized that the pleasures and benefits of such an organization consisted of more than having a name. The task of obtaining space suitable for use as a club radio station at the DSRC proved to be formidable because of the dearth of space for any project. A part of the club membership put a high priority on the business of establishing a 2-meter repeater. For this it was possible to

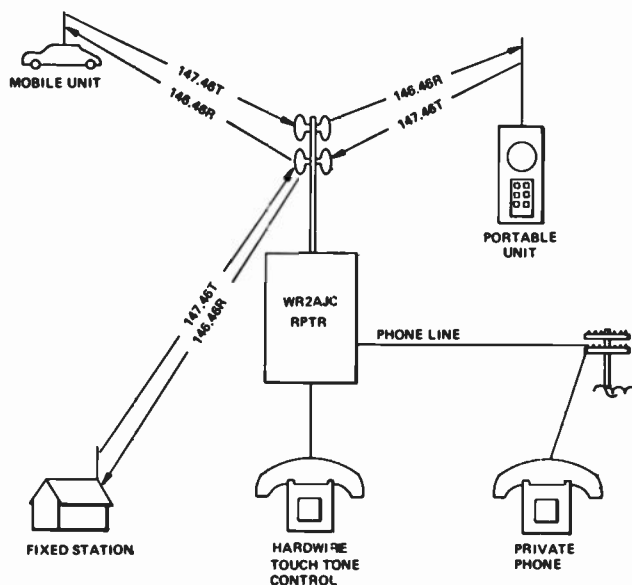

Fig. 1 System concept of the DSRC repeater station shows how WR2AJC can be addressed by various units in the system on a radio transmission (T) frequency of 147.46 MHz. The repeater retransmits the signal at 146.46 MHz. Hardwire phone lines enable calls to be made from mobile stations to telephones and are also a primary control of the repeater system.

obtain some space in a penthouse on the roof of one of the DSRC buildings. A repeater committee was formed with Bob Sanford, K2MQM, as chairman and Repeater Trustee and application for a repeater license was made. The club repeater first went on the air in August 1975 with the call WR1ABH/2, and it had a transmitter power output of 10 watts. On November 20th of that year, the repeater frequency was changed to eliminate interference with another repeater in northwest New Jersey. Power output was increased to 25 watts in December, and on December 22, 1975, our assigned call arrived and the new identification WR2AJC was first transmitted.

What is a repeater?

Used both in amateur and commercial radio, a repeater is a system composed of a single channel receiver tuned to the appropriate frequency and a transmitter to rebroadcast the received audio signal on a second frequency. The antenna is usually located high above the surrounding area to pick up weak signals from distant mobile stations and to provide good transmitter coverage. In some situations, the receiving and transmitting sites may be separated by several miles in which case voice communications between sites would be via telephone lines. Station WR2AJC uses a single transmitter site but has receiving sites at Willingboro and Somerville, N.J., as auxiliaries to the main receiver at Princeton. The auxiliary inputs transmit the signals that they receive over a 450-MHz link to a voting system at Princeton for re-transmission.

Components of the repeater

Fig. 1 shows the basic system concept of the repeater. (Details of the block labeled WR2AJC RPTR are shown in

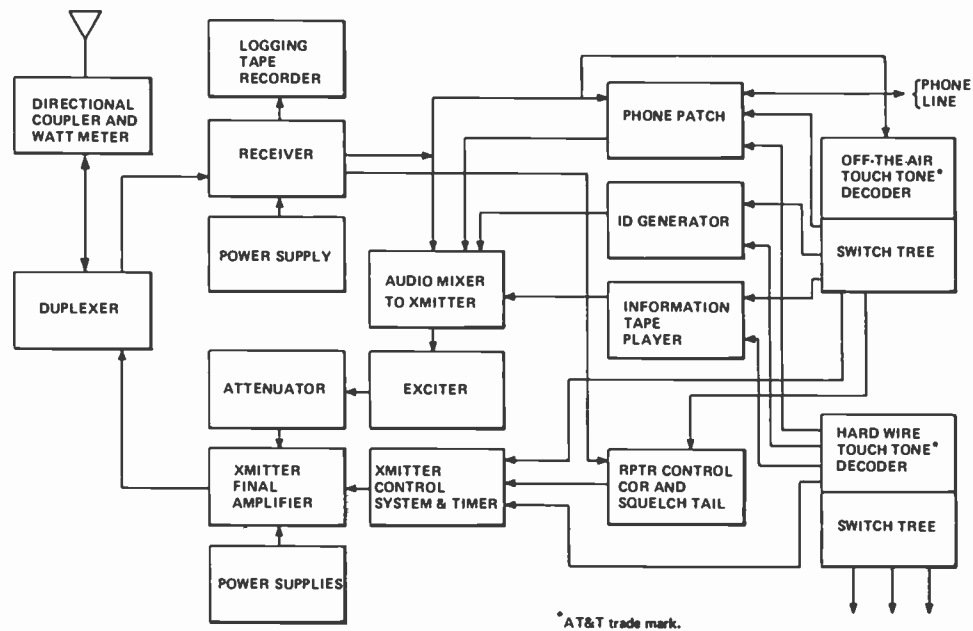

Fig. 2

Block diagram of the repeater shows the various elements used for reception, control, amplification, and retransmission of signals at 50 watts output.

the repeater block diagram of Fig. 2). In operation, a mobile station using the repeater transmits on a frequency of 147.46 MHz. This signal, picked up by the antenna, is sent through the duplexer to the receiver where the audio signal is detected. The audio is first sent to the mixer and then to the transmitter exciter where it modulates the oscillator signal. From the exciter, the modulated signal is routed to the final amplifier, where it is fed at a frequency of 146.46 MHz through the duplexer to the antenna to be reradiated.

The advantage of a repeater becomes evident when we compare signal strengths. With a low-power mobile input to the repeater of about 1×10^{-6} volt, there is a -107 dBm signal at the 50-ohm impedance antenna. This signal is amplified by the repeater to a level of 50 watts for a 145-dB gain and is radiated in an omnidirectional pattern to other mobile stations. The communication area covered by the mobile unit is thus extended to that of the transmitter coverage area.

The duplexer, mentioned above, is required for single-antenna repeater operation. In this case, the antenna must act as a receiving element at the same time it is transmitting a signal. This duplexer (a Phelps Dodge type 497-509) consists of six pass-notch resonators arranged with three in the receive section and three in the transmit section. A minimum of 85 dB isolation is provided in each of the two channels with an insertion loss of less than 1 dB. The resonators in the transmit section are tuned to provide maximum transfer of signal at the transmitter frequency with minimum transfer of signal at the receive frequency. Similarly, the receiver resonators are tuned for maximum signal transfer at the receive frequency with minimum transfer of signal at the transmit frequency.

The audio mixer provides the proper audio level for input to the transmitter and also allows simultaneous transmission

of several audio signals. FCC regulations require identification of repeaters every five minutes when in use. Station WR2AJC is arranged so that the identification signal from the ID generator is sent to the mixer at 5-minute intervals and transmitted with any audio signal present at that time. Other signals fed to the mixer come from the information tape and the phone patch. The information tape provides up-to-date news on DSRC activities as well as repeater information to visitors traveling through the area. The phone patch is especially useful in reporting accidents to the police and provides an opportunity to make calls from mobile stations to telephones in the local area of the repeater.

Some of the other sections shown in the repeater block diagram of Fig. 2 have the following functions:

Logging tape recorder—This audio tape recorder is activated by a received signal and records all signals coming into the receiver.

Repeater control, etc.—Normally, the repeater transmitter is off. When a signal is picked up by the receiver, the carrier-operated relay (COR) is activated and sends a signal to the transmitter control. When a transmission is completed and the received signal has dropped, the transmitter is kept on for a few seconds before it shuts down. This part of a transmission is known as the squelch tail, and the circuit that provides for it is part of the repeater control system.

Hardwire TT decoder—Primary control of the repeater system is accomplished through a telephone line. Should any problems occur during repeater operation, any one of the several control operators can command the repeater by means of the telephone line.

Off the Air TT decoder—A secondary system for operating the various sections of the repeater is by means of Touch

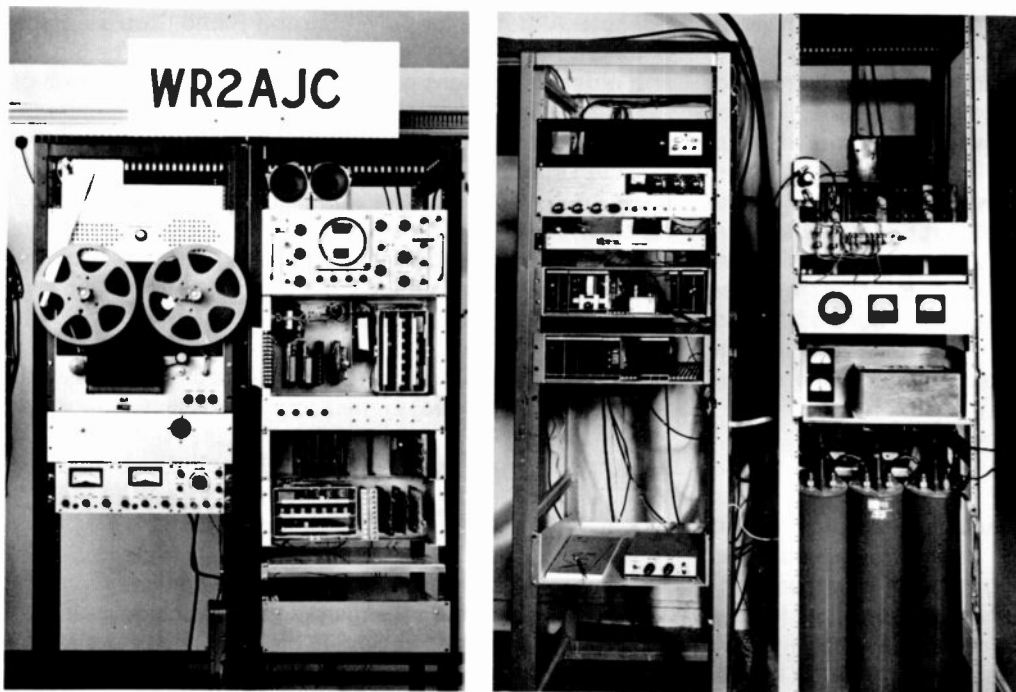

Fig. 3
Composite photograph of the repeater. At present the repeater occupies a portion of four racks (left to right): 1) off-the air audio tape deck for recording all input to the repeater; 2) carrier-operated relay, controls and decoding, and cassette tape decks; 3) audio, receiver and exciter; and 4) main power supply, transmitter, and duplexer.

Tone* signals sent over the air. By sending different combinations of tones, the system can also be made to transmit the ID, to activate the information tape player, operate the phone patch, or command the repeater off or on.

Transmitter Control, etc.—This section provides the on-off control of the repeater as commands are received from the decoders or receiver. Should any malfunction occur to keep the transmitter on, a built-in timer will shut the transmitter off after three minutes of continuous operation.

The foregoing description illustrates the versatility (and complexity) of the repeater. Modifications and improvements are continually being made. The initial antenna has been modified to provide 6 dB gain and the final power output has been increased to 50 watts. Auto-patch was added in 1976 and plans are being formulated to incorporate a microprocessor for repeater control and logging functions.

Fig. 3 is a composite photograph of the elements of the repeater. The rack on the left contains the monitor tape deck which records all inputs to the repeater. The next rack holds a test oscilloscope, phone line and off-the-air decoders, and controls. Behind the lowest panel in this rack is a cassette tape setup which currently contains the information tape player. The third rack from the left contains the UHF link monitoring equipment at the top. The phone patch and audio mixer panel are at the next level down, and just below that is the ID generator chassis. Below the ID generator is a nest containing the receiver, power supplies, and audio amplifier for the receiver and mixer. The lower nest contains the circuit boards for the exciter, timer,

and power supplies. On the shelf below the exciter nest is the exciter audio amplifier. The fourth rack holds the transmitter. At the top (attached to the frame) is the repeater license. The dummy load used for off-the-air tests rests just above the main power supply and its associated distribution panel at the top of the rack. The circular panel meter below the main power supply indicates the rf amplifier power output. The rf amplifier is on the chassis below the meter panel. On this chassis can be seen the dc power metering for the amplifier. In the base of this fourth rack is the duplexer. The array of three cavity filters in front are those tuned to the transmitter frequency. A similar set of three filters tuned to the receiver frequency are at the back of the rack.

Services of the DS radio club

The demonstrated effectiveness of the 2-meter repeater stimulated action to create an Emergency Communications Plan for the Laboratories. The David Sarnoff Radio Club participates with guidance, added manpower, and supportive communications facility through the use of the repeater. This plan has been implemented to the extent that security personnel, equipped with "handi-talkies," can communicate with each other and with Guard Headquarters. Liaison has also been established with the nearby West Windsor police, fire, and ambulance units through their assigned public service frequencies.

Another service came into being when non-amateurs indicated interest in code and theory training so that they might join the fun. Classes have been formed by the club to help these aspirants to prepare for obtaining the necessary FCC license. To date, 12 persons have obtained their Novice licenses, and 2 have upgraded to General.

* AT & T Trade Mark

Since the repeater has been activated, a growing number of hams are using it. It is an "open" repeater (not restricted to club members) and is especially active during commuting hours. Contacts between RCA employees heading to and from work at Princeton, Hightstown, and Somerville are commonplace. Non-RCA persons commuting at the same time as well as RCA retirees who want to exchange information with past associates help relieve the drabness of a long daily drive to work. This daily fellowship has in turn brought about a series of informal meetings of the "repeater gourmet club" at restaurants in the area covered by the repeater's signals. These dinner meetings provide an opportunity to make personal contact with some of our otherwise unseen friends.

Conclusion

Involvement in the hobby of amateur radio provides an opportunity for establishing new friendships and (particularly where co-workers unite in a common non-work project) for developing a new appreciation for the skills and personalities of people who otherwise might be only casual or business acquaintances. Organizing a club, assembling a club station or repeater, engaging in the tests or use of the equipment, and training others in the skills that will make the hobby available to them too, makes ham radio a stimulating and wonderful hobby.

Reprint RE-24-4-10 Final manuscript received May 15, 1978.

Ed. note: Although the David Sarnoff Radio Club is not the first RCA radio club it is not the last one either. The largest and oldest of present groups is the Manhattan Avenue of Americas Radio Club (MAARC) run by the NBC amateurs. About one-third of the 237 members are NBC employees. The club operates repeaters on 2 meters and 220 MHz and plans to have one in the 450-MHz region. The 2-meter repeater, WR2AHU, transmits on a frequency of 147.36 MHz with the input on 147.96 MHz. The antenna is located on the RCA building approximately 1000 feet above ground and the transmitter power output is 28 watts.

Also, in the Princeton area, the Astro-Electronics Amateur Radio Club has been formed and operates the repeater station WR2APA with an input frequency of 449.6 MHz and an output frequency of 444.6 MHz. The club also operates WB2JQR on the low bands with a beam as well as a 250-ft dipole antenna.

At Somerville, the Solid State VHF Club has been formed, and work is going toward equipping and installing a satellite receiver for WR2AJC at Somerville. This receiver site will permit operation through the repeater by mobile stations that are ordinarily blocked off from the Princeton antenna by intervening hills. Signals picked up by the Somerville receiver will be relayed by a UHF link to Princeton for transmission through the repeater there.

DAVID SARNOFF RADIO CLUB

Organized March 6, 1975

For development of:

- Fellowship
- Individual proficiency
- Preparedness for emergency communications

This has led to:

- Club meetings for the exchange of ideas, news, experiences of interest to hams
- A 2-meter FM repeater serving hams over a 50-mile radius
- An Emergency Communications Plan involving the repeater and club members
- Training classes so that non-licensed persons may obtain amateur radio operators licenses

Some of the hams who brought together the first repeater include (left to right) **John Valachovic, K2GOX**; **George Bodeep, WA2ZNS**; **Bill McMillan, W2BMA**; **Bob Sanford, K2MQM**; and **Bill Haldane, AC2F**.



Dates and Deadlines

Upcoming meetings

Ed. Note: Meetings are listed chronologically. Listed after the meeting title (in bold type) are the sponsor(s), the location, and the person to contact for more information.

MAR 6-8, 1979—Optical Fiber Communication (IEEE, OSA) Shoreham Americana Hotel, Washington, DC **Prog Info:** Optical Soc. of America, 2000 L Street, N.W., Suite 620, Washington, DC 20036

MAR 13-16, 1979—Audio Engrg. Soc. 62nd Technical Mtg. and Exhibit, Sheraton, Brussels, Belgium **Prog Info:** Donald J. Plunkett, AES, 60 E. 42nd St., New York, NY 10017

MAR 14-16, 1979—Simulation Symposium (IEEE) Tampa, FL **Prog Info:** Dr. Joe Clema, Simulation Tech., 4124 Linden Ave., Dayton, OH 45432

MAR 19-21, 1979—Fourth Annual Control of Power Systems Conf. (IEEE) Texas A&M U., College Sta., TX **Prog Info:** B. Don Russell, Electric Power Institute, Dept. of Elect. Engr., Texas A&M, College Sta., TX 77843

MAR 25-28, 1979—Natl. Association of Broadcasters Conv., Dallas, TX **Prog Info:** NAB, 1771 N St., N.W., Washington, DC 20036

MAR 27-30, 1979—Vehicular Technology (IEEE) Arlington Heights, Chicago, IL **PROG Info:** Al Goldstein, Natl. Mgr. Field Engr., Motorola, Inc., 1301 E. Algonquin Road, Schaumburg, IL 60196

APR 2-4, 1979—Acoustics, Speech & Signal Processing (IEEE) Intl. Inn, Washington, DC **Prog Info:** Anthony Eller, Naval Research Laboratory, Washington, DC 20375

APR 2-4, 1979—American Nat'l. Metric Councils Fifth Annual Conf. (ANMC) Hyatt Regency, Washington, DC **Prog Info:** Dene Joyce, American Nat'l. Metric Council, 1625 Massachusetts Ave., NW, Washington, DC 20036 (202-232-4545)

APR 3-5, 1979—Space Instrumentation for Atmospheric Observation (IEEE) El Paso Civic Center, El Paso, TX **Prog Info:** Dr. Joseph H. Pierluissi, Dept. of Elect. Engrg., U. of Texas at El Paso, El Paso, TX 79968

APR 18-20, 1979—Lasers for Material Processing (American Society for Metals) Hyatt Regency, Washington, DC **Prog Info:** James J. Lombardo, ASM, Metals Park, OH 44073

APR 23-25, 1979—Intl. Symp. on Computer Architecture (IEEE) Marriott Hotel, Philadelphia PA **Prog Info:** Dr. Barry Borgerson, Sperry Univac, P.O. Box 500, Blue Bell, PA 19424 (215-542-2013)

APR 24-26, 1979—ELECTRO (IEEE) Coliseum, New York, NY **Prog Info:** W. C. Weber, Jr., Program Chairman, ELECTRO, 999 N. Sepulveda Blvd., El Segundo, CA 90245 (213-772-2965)

APR 24-26, 1979—Reliability Physics Symp. (IEEE) Airport Hilton, San Francisco, CA **Prog Info:** Dr. Frank B. Micheletti, Rockwell International, 3370 Miraloma Ave., Anaheim, CA 92803

APR 25-27, 1979—Conf. on Modeling and Simulation, U. of Pittsburgh, Pittsburgh, PA **Prog Info:** W.G. Vogt, Modeling and Simulation Conf., 348 Benedum Engineering Hall, U. of Pittsburgh, Pittsburgh, PA 15261

APR 28-MAY 2, 1979—American Ceramic Soc. 81st Annual Mtg. and Exposition, (ACS) Convention Center, Cincinnati, OH **Prog Info:** American Ceramic Society, Inc., 65 Ceramic Drive, Columbus, OH 43214 (614-268-8645)

APR 30-MAY 2, 1979—Intl. Microwave Symp. (IEEE) Sheraton Twin Towers, Orlando, FL **Prog Info:** R.E. Henning, College of Engr., University of South Florida, Tampa, FL 33620 (813-974-2581)

MAY 7-10, 1979—Design Engrg. Conf. (ASME) McCormick Place, Chicago, IL **Prog Info:** American Soc. of Mechanical Engineers, United Engineering Center, 345 E. 47th St., New York, NY 10017 (212-644-2129)

MAY 8-10, 1979—Society for Information Display Int. Symp. (SID) Chicago Marriott Hotel, Chicago **Prog Info:** Lewis Winner, 301 Almeria Ave., P.O. Box 343788, Coral Gables, FL 33134

MAY 14-17, 1979—Industrial and Commercial Power Systems Conf. (IEEE) Washington Plaza, Seattle, WA **Prog Info:** T.E. Sparling, T.E. Sparling & Assoc., 1920 Eastlake Ave., Seattle, WA 98102 (206-325-7770)

MAY 15-17, 1979—National Aerospace & Electronics Conf. (NAECON) (IEEE) Dayton Convention Ctr., Dayton, OH **Prog Info:** NAECON, 140 E. Monument Ave., Dayton, OH 45402 (513-255-3627)

MAY 30-JUN 1, 1979—Clea '79, Washington Hilton Hotel (IEEE, Optical Soc. of America) **Prog Info:** Susan C. Henman, Courtesy Associates, 1629 K St., NW, Suite 700, Washington, DC 20006

JUN 4-7, 1979—National Computer Conf. (AFIPS, IEEE) New York, NY **Prog Info:** Thomas C. White, American Federation of Information Processing Societies, 210 Summit Ave., Montvale, NJ 07645 (201-391-9810)

JUN 11-13, 1979—Intl Conf. on Communications (IEEE) Sheraton Hotel, Boston, MA **Prog Info:** Richard C. Stiles, Director Telecommunications Planning, GTE Labs. Inc., 40 Sylvan Road, Waltham, MA 02154 (617-890-8460 ext. 301) or Duane Mattisen (617-862-5500 ext. 5400)

JUN 12-14, 1979—Intl. Pulsed Power Conf. (IEEE) South Park Inn, Lubbock, TX **Prog Info:** Dr. M. Kristiansen, Texas Tech. U., Box 4439, Lubbock, TX 79409 (806-742-35330)

JUN 18-22, 1979—Intl. IEEE/AP Symp. & USNC/URSI Mtg. Seattle, WA **Prog Info:** I. Peden, Dept. of Elect. Engr., U. of Washington, Seattle, WA 98195 (206-543-0340)

JUN 19-21, 1979—Power Electronics Specialists Conf. (IEEE) San Diego, CA **Prog Info:** Jerrold Foutz, code 9234, Naval Ocean Systems, San Diego, CA 92152 (714-225-2752)

JUN 25-27, 1979—Design Automation Conf. (IEEE) Cherry Hill, NJ **Prog Info:** Harry Hayman, P.O. Box 639, Silver Springs, MD 20901 (301-981-0060)

Calls for papers

Ed. Note: Calls are listed chronologically by meeting date. Listed after the meeting (in bold type) are the sponsor(s), the location, and deadline information for submittals.

APR 22-26, 1979—22nd Semiannual Inst. of Printed Circuits Mtg. (IPC) Sheraton Boston Hotel, Boston, Mass. **Deadline Info:** 3/1/79 abs. to Institute of Printed Circuits, 1717 Howard St., Evanston, IL 60202

JUN 12-14, 1979—Intl. Pulsed Power Conf. (IEEE) South Park Inn, Lubbock, TX **Deadline Info:** 3/15/79 150-word abs. to M. Kristiansen, Dept. of Elec. Engrg., Texas Tech. U., P.O. Box 4439, Lubbock, TX 79409

JUN 2-5, 1979—Ninth Int'l Conf. on Laser Atmospheric Studies (Optical Soc. of America/German Soc. of Appl. Optics/German Meteorological Soc.) **Deadline Info:** 300-word abs. to C. Werner, Institute of Atmospheric Physics, DFVLR, Oberpfaffenhofen, D-8031 Wessling, West Germany

Patents

Astro Electronics

T.J. Cunningham|D.H.L. Schwartzberg
Solder connection between copper and aluminum conductors—4129744

Automated Systems

R.J. Bosselaers
Frequency synthesizer with frequency modulated output—4119925

B.R. Clay|D.A. Gore
Hologram having expanded viewing area—4130338

R.E. Hanson|R.E. Tetrev
Compression test using battery voltage waveform during cranking—4126037
(Assigned to U.S. Government)

Avionics Systems

K.C. Adam|F.C. Easter
Over-current protection circuit for voltage regulator—4127885

F.C. Easter
Over-current protection circuit for voltage regulator—4127886

E.B. Gamble
D-C converter using pulsed resonant circuit—4128868

K. Katagi
Image resolution enhancement method and apparatus—4127873

K. Katagi
Range mark generation—4128834

Broadcast Systems

A.M. Goldschmidt
Turntable rotational speed and phase control system for a video disc play/record apparatus—4123779

M.R. Johns
Circularly polarized antenna using slotted cylinder and conductive rods—4129871

A.C. Luther, Jr.|D.A. Sauer
AM transmitter with an offset voltage to the RF stage to compensate for switching time of the modulators—4122415

C.R. Mills
Circuit test apparatus—4129826

J.S. Oblak|P.J. Schmalz
Shielded, DC-isolated RF connector assembly—4122416

Consumer Electronics

L.A. Cochran|R.L. Shanley, II
Service switch arrangement for a color television receiver—4123776

R.E. Fernsler|D.W. Luz|J.C. Peer
Inrush current start-up circuit for a television receiver—4127875

C.J. Martin|R.J. Ryan
Vinyl-chloride-based injection molding composition—4129536

R.L. Shanley, 2nd
Kinescope beam current limiter employing automatic sequential control of image contrast and brightness to limit beam current—4126884

D.H. Willis
High voltage protection circuit—4126816

Government Communications Systems

L.P. Nahay
Digital time division multiplex switching system—4119807 (Assigned to U.S. Government)

E.J. Nossen|V.F. Volertas
Unidirectional phase-shift-keyed communication system—4130802

Laboratories

L. Abbott|G.W. Beakley|R.E. Flory
System for passing two color tv signals through non-linear path—4120001

C.H. Anderson
Beam guide for display device with beam injection means—4128784

R.A. Bartolini|J.P. Russell
Duplicating a holographic record by using two reference beams—4121881

H.R. Beelitz|D.R. Preslar
Integrated circuit mesa bipolar device on insulating substrate incorporating schottky barrier contact—4127860

H.R. Beelitz|D.R. Preslar
Electrical circuit for multiplexing and dividing different bands or frequencies—4127820

A.E. Bell|D.E. Carlson|B.F. Williams
Photovoltaic device having increased absorption efficiency—4126150

D.P. Bortfeld|R.W. Cohen|D.A. DeWolf
Electron gun having a distributed electrostatic lens—4124810

J.E. Carnes|R.H. Dawson
Balanced capacitance charge transfer device—4126836 (Assigned to U.S. Government)

T.N. Chin
Cathode for flat-panel display—4119882

T.L. Credelle
System for achieving image uniformity in display devices—4121137

J.M. Cusack
Method and apparatus for determining a signal of uniform period—4121211
(Assigned to U.S. Government)

W. Denhollander
Side pincushion correction circuit with low dissipation damping—4130783

D.W. Fairbanks
Solar energy heat apparatus—4126121

E.C. Fox
Signal defect detection and compensation with signal de-emphasis—4119812

J.S. Fuhrer|E.O. Keizer
Narrowed-electrode pickup stylus for video disc systems—4124867

R.A. Gange
Cathode structure and method of operating the same—4121130

L.A. Goodman|W.B. Hall|K.W. Hang
Self illuminated liquid crystal display device—4126384

L.A. Goodman|D. Meyerhofer
A.W. Levine
Electro-optic device—4120567

P.E. Haferl
Correction circuit for load-dependent raster distortion—4129806

G.M. Harayda
Data encoding keyboard—4120044

A.C. Iprj|J.H. Scott, Jr.
Integrated circuit structure and method for making same—4119992

K. Knop
Fine-line diffractive subtractive color filters—4130347

H. Kressel|F.Z. Hawrylo
Lateral mode control in semiconductor lasers—4122410 (Assigned to U.S. government)

H.W. Lehmann|R.W. Widmer
Fabrication of multi-level relief patterns in a substrate—4124473

H.G. Lewis, Jr. | S.B. Calo
Error detection and correction—4119945

E.S. Lo
Novel amino siloxane lubricants—4127872

D.P. Marinelli
Method for depositing epitaxial semiconductor from the liquid phase—4123302

F.J. Marlowe
Electron-gun control system—4126814

J.H. McCusker | S.S. Perlman
Uniform surface acoustic wave transducer configuration having improved frequency selectivity—4126838

J.W. Mirsch
Multilayered deflection yoke—4128824

K. Miyatani | I. Sato
Grooved n-type TiO₂ semiconductor anode for a water photolysis apparatus—4124464

E.S. Poliniak | N.V. Desai
Method of transferring a surface relief pattern from a wet poly(olefin sulfone) layer to a metal layer—4126712

L.R. Rockett, Jr.
CCD binary-to-gray code generator—4119961

F.N. Sechi
Microwave coupler—4124823

C.F. Smollin
Circuit for rearranging word bits—4130886

D.J. Tamutus
Method of making a thermoplastic lens by vacuum forming—4129628

S. Weisbrod
Image display device commutator—4129804

C.M. Wine
Memory type tuning system with provisions to facilitate setup—4123713

Mobile Communications Systems

D.F. Medendorp | P.C. Schwabel
Amplifier protection circuit—4133400

Missile and Surface Radar

T.V. Bolger | R.A. Dischert
Signal defect compensator—4122489

C.E. Profera
Antenna feed network—4122453
(Assigned to U.S. Government)

Picture Tube Division

J.T. Coble
Spiked low-voltage aging of cathode-ray tubes—4125306

B.G. Marks
High-voltage electron-tube base with drip relief means—4127313

W.D. Masterton
Cathode ray tube with corrugated mask having a corrugated skirt—4122368

J.J. Moscony | G.S. Gadbois
Etching a succession of articles from a strip of sheet metal—4126510

W.A. Sonntag | T.F. Simpson
Method and apparatus for simulating magnetic environment of television receivers—4122485

RCA Ltd., Canada

V.R. Krishnamurthy
Cathode-ray tube with double tension band—4121257

C.K. Mok
Array of directional filters—4129840

P.P. Webb
Multi-element avalanche photodiode having reduced electrical noise—4129878

RCA Service Co.

J.K. Randolph
Automatic release mechanism for a tether—4126850

Solid State Division

A.A. Ahmed
Delayed kinescope blanking pulse generator—4126815

A.A. Ahmed
Switchable current amplifiers—4119924

L.S. Greenberg
Plastic-encapsulated semiconductor devices—4124864

W. Hulstrunk
Semiconductor device having reduced leakage current—4122483

S.W. Kessler, Jr. | J.A. Olmstead
Semiconductor device with ballast resistor adapted for a transcaent device—4126879
(Assigned to U.S. Government)

B.A. Kirschner
Phase-lock-loop indicator—4125815

J.T. O'Brien | A.C. Limm
P. Nyul | V.S. Tassia, Jr.
Radiation emitter-detector package—4125777

C.J. Petrizio
Touch switch circuits—4119864

O.H. Schade, Jr.
Low-leakage gate-protection circuit—4126830

SelectaVision Project

J.A. Allen | C.F. Coleman
Stylus position control system—4128247

C.F. Coleman
Video disc insertion/extraction system for a video disc player—4124866

J.H. Helm
Rotational restraint for a video disc package—4124118

Patent honorarium increased

For U.S. patent applications filed after Jan. 1, the RCA honorarium paid to a sole inventor has been increased from \$200 to \$400. For joint inventors, it has been raised from \$250 to \$500 to be divided equally among the inventors.

The honorarium paid for a Technical Note remains unchanged, namely, \$75 for a sole inventor and \$100 divided equally among joint inventors.

Pen and Podium

Recent RCA technical papers and presentations

To obtain copies of papers, check your library or contact the author or his divisional Technical Publications Administrator (listed on back cover) for a reprint. For additional assistance in locating RCA technical literature, contact RCA Technical Communications, Bldg. 204-2, Cherry Hill, N.J., extension 4256.

Advanced Technology Laboratories

G.J. Ammon

Wideband optical disc archival data storage—*Proc. Electro-Optics System Design Conf.*, Boston, MA (9/19/21/78)

R. Gordon

Compound hybrids with LSI for a mini RPV-carrier circuit—*Electronic Packaging & Production*, Vol. 18, No. 11 (11/78) pp. 39-50

G. Hunka

Aided-track cursor for improved digitizing accuracy—*Photogrammetric Engr'g. & Remote Sensing*, Vol. XLIV, No. 8 (8/78) pp. 969-1096

H.W. Kaiser|J.I. Pridgen|L.J. Palkuti

High speed radiation hard CMOS/COS code generator for satellite applications—*Proc. IEEE Workshop*, Vail, CO (10/4-6/78)

P.W. Ramondetta

Neutron dosimeter development model—*J. Health Physics*, Vol. 35, No. 6 (12/78) pp. 835-847

P.C. Scott|M. Mintz

A hierarchical decision model for large-scale public system planning—*Proc. 1978 Int'l. Conf. on Cybernetics and Society*, Tokyo (11/3-5/78), Kyoto (11/7/78)

E.S. Shecter

Quality assurance and its role in Air Force procurement—*Air Force Systems Command Annual Contracting and Manufacturing Conf.*, Andrews Air Force Base, MD (10/31/78)

E.S. Shecter

Design for reliability—33rd ASQC Midwest Conf., Dallas TX (10/12/78)

Astro Electronics

F. Drago|J. Goel

GaAs FET power amplifiers for communication transponders at 4 and 15 GHz—*EASCON '78*, Washington, D.C. (9/26/78)

K. Eng|M. Hecht

Switch matrix for TWTAs redundancy on communication satellites—*Nat'l. Telecommunications Conf.*, Birmingham, AL (12/4-6/78)

G. Niederoest

Finite element methods in spacecraft dynamic analysis—*RCA Review*, Vol. 39 (12/78)

J. Staniszewski

DMSP Block 5D—the "smart" spacecraft—*AIAA/NASA Conf. on "Smart" Sensors*, Hampton, VA (11/14-16/78)

Automated Systems

T.E. Fitzpatrick|R.E. Hanson

F.W. Hohn|R.T. Cowley
Diagnosis of combat vehicle systems using simplified test equipment—*Mechanical Failures Prevention Symp.*, San Antonio, TX (11/78)

T.E. Fitzpatrick|R.E. Hanson

D.S. Sarna|J.W. Steyaert
STE/FVS—total combat vehicle support with simplified test equipment—*AUTOTESTCON '78*, San Diego, CA (11/78)

H.A. Goldstand

Software techniques for a microprocessor-based data acquisition device—*AUTOTESTCON '78*, San Diego, CA (11/78)

F.P. McGurk

Design to unit production cost—principles and practices—*Western New England College*, Burlington, MA (5/78)

L.S. O'Hara

2.06-micron eyesafe laser rangefinder—*DoD Laser Conf.*, San Diego, CA (11/78)

V.J. Stakun|W.H. White

Laser testing at the intermediate maintenance level—*AUTOTESTCON '78*, San Diego, CA (11/78)

R.E. Turkington|H. Kaunzinger

Novel language features in OPAL—*AUTOTESTCON '78*, San Diego, CA (11/78)

R.J. Wildenberger|T.J. Dudziak

J.F. Kelly
An automatic in-process microcircuit evaluation (AIME) system—*AUTOTESTCON '78*, San Diego, CA (11/78)

Laboratories

M.S. Abrahams|W.E. Ham

Some effects of planar defects near the SiO interface on electrical properties of SOS/MOS devices, *Appl. Phys. Lett.*, Vol. 33, No. 8 (10/15/78)

R.A. Bartolini|A.E. Bell|R.E. Flory

M. Lurie|F.W. Spong
Optical disk systems emerge—*IEEE Spectrum* (8/78)

J. Blanc

A revised model for the oxidation of Si by oxygen—*Appl. Phys. Lett.*, Vol. 33, No. 5 (9/1/78)

A. Bloom|R.A. Bartolini|H.A. Weakliem

Organic materials for optical devices—*Optical Engineering*, (Sep/Oct 1978)

D. Botez

Single-mode cw operation of "double-dovetail" constricted DH (AlGa)As diode lasers—*Appl. Phys. Lett.*, Vol. 33, No. 10 (11/15/78)

G.R. Briggs|S.J. Connor

J.O. Sinniger|R.G. Stewart
40-MHz CMOS-on-sapphire micro-processor—*IEEE Trans. on Electron Devices*, Vol. ED-25, No. 8 (8/78)

C.A. Catanese|J.G. Endriz

The physical mechanisms of feedback multiplier electron sources—*IEEE Trans. on Consumer Electronics*, Vol. CE-24, No. 3 (8/78)

L.S. Cosentino|V. Christiano|J.G. Endriz

J. Dresner|G.F. Stockdale|J.L. Cooper
J.N. Hewlitt|J.B. Harrison, Jr.
Feedback multiplier flat-panel technologies—*IEEE Trans. on Consumer Electronics*, Vol. CE-24, No. 3 (8/78)

B.J. Curtis|H.J. Brunner

End point determination of aluminum CCl₄ plasma etching by optical emission spectroscopy—*J. Electrochemical Soc.*, Vol. 125, No. 5 (5/78)

A.H. Firester|C.B. Carroll|I. Gorog

M.E. Heller|J.P. Russell|W.C. Stewart
Optical readout of the RCA VideoDisc—*RCA Review*, Vol. 39, No. 3 (9/78)

A.H. Firester|I. Gorog|J.P. Russell

J.J. Gibson|C.B. Carroll|W.R. Roach
Optical recording techniques for the RCA VideoDisc—*RCA Review*, Vol. 39 (9/78)

W.H. Fonger|C.W. Struck

Relation of the Lauer-Fong formula to the SCC model: application to Sm²⁺5d-5D crossovers—*J. Chemical Physics*, Vol. 69, No. 9 (11/1/78)

A.M. Goodman

Optical interference method for the approximate determination of refractive index and thickness of a transparent layer—*Appl. Optics*, Vol. 17 (9/1/78) p. 2779

I. Gorog

VideoDisc optics—*RCA Review*, Vol. 39 (9/78)

- S.T. Hsu
Electron mobility in SOS films—*IEEE Trans. on Electron Devices*, Vol. ED-25, No. 8 (8/78)
- S.A. Keneman|J.G. Endriz
C.A. Catanese|L.B. Johnston
Flat tv display using feedback multipliers—*IEEE Trans. on Consumer Electronics*, Vol. CE-24, No. 3 (8/78)
- H. Kiess|R. Clarke
Pyroelectric effect in PTS—*Phys. Stat. Sol. (A)*, Vol. 49 (1978) p. 133
- K. Knop
Reflection grating polarizer for the infrared—*Optics Communications*, Vol. 26, No. 3 (9/78)
- I. Ladany|H. Kressel
Degradation in short wavelength (AlGa)As light-emitting diodes—*Electronics Lett.*, Vol. 14, No. 13 (6/22/78) pp. 407-409
- H.W. Lehmann|K. Frick|R. Widmer
J.L. Vossen|E. James
Reactive sputtering of PTFE films in argon-CF₄ mixtures—*Thin Solid Films*, Vol. 52 (1978) pp. 231-235
- J.J. Mezrich
Modification of spatial frequency processing rates with multiple frequency stimuli—*Vision Research*, Vol. 18, No. 11 (1978) pp. 1505-1507
- A. Miller
Elasto-optical technique for measurement of stress at surfaces—*Appl. Phys. Lett.*, Vol. 33, No. 7 (10/1/78)
- A. Okda|Y. Ohnuki|T. Inada
AES measurements on anodically oxidized layers of single crystal GaP—*Appl. Phys. Lett.*, Vol. 33, No. 5 (9/1/78)
- G.H. Olsen|M. Ettenberg|R.V. D'Aiello
Vapor-grown InGaP/GaAs solar cells—*Appl. Phys. Lett.*, Vol. 33, No. 7 (10/1/78)
- G.H. Olsen|C.J. Nuese|R.T. Smith
Effect of lattice-mismatch stress on the energy band gap and lattice parameter of III-V heteroepitaxial layers—*J. Vac. Sci. Technol.*, Vol. 15, No. 4 (July/Aug 1978)
- D. Redfield
Mechanism of performance limitations in heavily doped silicon devices—*Appl. Phys. Lett.*, Vol. 33, No. 6 (9/15/78) pp. 531-533
- W.R. Roach|C.B. Carroll|A.H. Firester
I. Gorog|R.W. Wagner
Diffraction spectrometry for VideoDisc quality control—*RCA Review*, Vol. 39, No. 3 (9/78)
- J.R. Sandercock
Light scattering from surface acoustic phonons in metals and semiconductors—*Solid State Communications*, Vol. 26 (1978) pp. 547-551
- P. Sheng
Theoretical considerations of optical diffraction from RCA VideoDisc signals—*RCA Review*, Vol. 39, No. 3 (9/78)
- E.K. Sichel|J.I. Gittleman
Characteristics of the electrochromic materials Au-WO₃ and Pt-WO₃—*J. of Electronic Materials*, Vol. 8, No. 1 (1979)
- E.K. Sichel|J.I. Gittleman
Transport and optical properties of electrochromic Au-WO₃cermets—*Appl. Phys. Lett.*, Vol. 33, No. 7 (10/1/78)
- R. Williams|R.S. Crandall|A. Bloom
Use of carbon dioxide in energy storage—*Appl. Phys. Lett.*, Vol. 33(5) (9/78)
- P.J. Zanzucchi|M.T. Duffy
Surface damage and the optical reflectance of single-crystal silicon—*Appl. Optics*, Vol. 17 (22/1/78) p. 3477
- ### Missile and Surface Radar
- J.A. Bauer
Comparison of high-speed timing systems utilizing PC board and hybrid techniques—*IEEE Computer Packaging Group*, NYC (10/13/78)
- F.J. Buckley
Standard for software quality assurance plans—*Proc.*, IEEE Conf. on Software Applications COMSAC, Chicago, IL (11/15/78)
- F.J. Buckley
Management of RT programming—*Drexel University*, Phila., PA (11/8-10/78)
- M.W. Buckley
Project management—*Engr'g Mngmt. Conf.*, Denver, CO (10/16-18/78); *Adv. Proj. Mngmt Seminar*, London, England (10/24-25/78); *IEEE Continuing Education*, Portland, OR (11/3-4/78)
- S.D. Cottrill|P. Gelznis|W.J. Ince
Operation of SAW reflective array pulse compressors in a high performance radar with 0.4 meter range resolution—*Proc.*, AGARD Avionic Panel Symp., Neuilly Sur Seine, France (10/11-15/77)
- D.J. Dempsey
Rangemaster: application of a new but mature technology—*Proc.*, Phased Array Instrumentation Radar Systems Technical Conference, M&SR, Moorestown, NJ (11/2/78)
- C.N. Falcon
Testing of systems developed by the incremental build method—*Workshop on Software Testing and Test Documentation*, Ft. Lauderdale, FL (12/18-20/78)
- J.W. Hurley
Industrial logistics management—*Society of Logistics Engineers*, Phila. Chapter, Temple U., Phila., Pa. (10/3, 11/6, 11/14, 11/28, 12/5/78)
- P.R. Jackson
DoD R&D radar directions—*EIA Symp. on the Future of Government Electronics*, Los Angeles, CA (10/24-26/78)
- R. Lieber|J. Liston
G. Sparks|R. Udicious
Aircraft course direction—*IEEE Control Theory Group*, RCA M&SR, Moorestown, NJ (Sponsored by Univ. of Pa.) (11/15/78)
- W.T. Patton
Microwave design for reliability/availability—the AN/SPY-1 radar—*Military Microwaves*, Wembley, London, England (10/25-27/78)
- W.T. Patton
Phased array: the heart of the system—*Proc. Phased Array Instrumentation Radar Systems Technical Conference*, M&SR, Moorestown, NJ (11/2/78)
- R.J. Rader
Real-time programming—*Drexel University*, Phila., PA (11/8-10/78)
- D. Shore|J.B. Tindall
Mobile tactical C³ systems—*36th Tech. Mtg. of the Avionics Panel*, U.S. Naval Postgraduate School, Monterey, CA (10/18-21/78)
- R.J. Soggi
The Aegis radar receiver—*Microwave Journal*, Vol. 21, No. 10 (10/78) pp. 38-47
- J.C. Volpe
Phased array instrumentation radar systems—*Proc. Phased Array Instrumentation Radar Systems Technical Conf.*, M&SR, Moorestown, NJ (11/2/78)
- K.H. Wedge
Generic phased array radar—*Proc. Phased Array Instrumentation Radar Systems Technical Conf.*, M&SR, Moorestown, NJ (11/2/78)
- M.L. Weisbein
Up-to-date approach to software quality assurance—*Trans.*, ASQC 22nd Annual Symp., NSIA-DCAS Conf., Phila., PA (10/15/78)

Engineering News and Highlights

Griffiths announces creation of VideoDisc operation

Edgar H. Griffiths recently announced RCA's decision to launch its "SelectaVision" VideoDisc product in the United States. He said RCA will proceed with maximum speed for the earliest possible market introduction of the product, with a schedule to be announced later this year.

Mr. Griffiths noted that the research and development of the video disc had been a corporate project. "Now that we have decided to launch this product in the United States it has been turned over to the appropriate operating activity for market introduction," he said.

Development of software for the new video disc will continue to be the responsibility of Herbert S. Schlosser, RCA Executive Vice President.

The following is a rundown of the major organizational changes brought about by this decision.

Pollack heads VideoDisc, SSD and CE

Roy H. Pollack has assumed responsibility for the newly created "SelectaVision" Video



Disc Operations and the Solid State Division. He continues to be responsible for the Consumer Electronics Division where he had been Vice President and General Manager since 1974. President Edgar H. Griffiths announced on Jan. 11 that Mr. Pollack will be proposed for election as an RCA Group Vice President at the Feb. 7 Board of Directors meeting.

Brandinger moves to VideoDisc

Jay J. Brandinger has been appointed Division Vice President, SelectaVision VideoDisc Operations. Dr. Brandinger was previously Division Vice President, Engineering, Consumer Electronics Division.



Sauter to manage CE

Jack K. Sauter has been named Division Vice President and General Manager of the Consumer Electronics Division. He was most recently Division Vice President, Marketing, for Consumer Electronics.

Bingham becomes VP, Engineering, at CE

J. Peter Bingham will succeed J.J. Brandinger as Division Vice President, Engineering, Consumer Electronics Division. Dr. Bingham was formerly Chief Engineer, New Products Laboratory.

Sonnenfeldt is VP, Special Corporate Projects

Richard W. Sonnenfeldt, who as Vice President, SelectaVision VideoDisc Project, spearheaded the technical development of the product, has been appointed Vice President, Special Corporate Projects.



Latham is Division VP, Engineering, at GSD

Donald C. Latham has joined Government Systems Division, Moorestown, as Division Vice President, Engineering. He succeeds Paul E. Wright, who has been appointed Division Vice President, Operations, at Astro-Electronics.

An engineering executive with 15 years business experience, Mr. Latham was most recently Director of Research and Engineering at Martin Marietta Aerospace in Orlando, Florida.

Neumann is TPA for Mobile Communications

Karl L. Neumann has been designated Technical Publications Administrator for Mobile Communications Systems at Meadow Lands, PA. In his more than 38-year long RCA career, Karl has been involved in communications engineering. He is currently Manager of Advanced Development Engineering for Mobile Communications Systems.



Swaim is Chief Engineer at Globcom

Joe T. Swaim has recently been appointed Chief Engineer of RCA Global Communications, Inc. He has overall responsibility for management of cost, schedule, technical performance, and talent development of the Engineering Department.

Mr. Swaim has 19 years of professional experience in commercial product development and military systems, primarily in digital communications, computer and terminal design and application.

His experience includes project and line management, product planning, marketing, and marketing support.

Lancaster Hosts First Manufacturing Engineering Productivity Symposium

The first technical symposium for engineers and managers in manufacturing activities at RCA was held on December 12, 1978 at the Lancaster plant. Attended by 100 RCA employees from plants in the United States, Canada and Mexico, the symposium provided the opportunity for many of RCA's key manufacturing personnel to meet, exchange experiences, and develop links for future communications.

Jim Miller, Director, Mfg. Systems and Technology Research Lab, and the symposium chairman, introduced the following presentations, which were videotaped and will be available for controlled loans to interested locations. Contact Hans Jenny, tel. 222-4251, for information on obtaining these tapes.

Fred Pfifferling, Mgr., Test Engineering, CCSD/GSD: "Low-Volume Manufacturing"—covered the building and testing of products in quantities ranging

from several per year to several hundred per month.

Steve Race, Mgr., Mfg. Projects, CE: "IEMS"—showed a modern production facility for color television sets producing hundreds of units per day.

James Scantzos, Mgr., Production Engineering, PTD: "Mechanization and Robotics"—reviewed a number of projects to modernize picture tube manufacture including the use of robots.

Stu Levy, Mgr., Computer Aided Mfg., SSD: "Computer Aided Manufacturing"—showed systems aimed at manufacturing logistics control, test data collection and analysis, and process monitoring and control.

Dave Mishra, Mgr., Engineering and Operations Services, Records: "Automatic Identification Systems"—described the Record Division's product identification and control system.

Gust Diamantoni, Mgr., Industrial Engineering, EO&D: "Uses of Video Tape for Cost Improvement"—provided examples of uses in training, time study, process development, cost reduction, and technology transfer and documentation.

Wane Jordon, Electrical Facilities Engineering, Banquet:—"Banquet Refrigeration System"—detailed an example of what high technology (computer control) can do for a rather mature facility.

A valuable feature of the symposium was the opportunity for many of RCA's key manufacturing personnel to meet, exchange experiences, and develop links for future communications.

Staff announcements

Solid State Division

Carl R. Turner, Division Vice President, Integrated Circuits, announced the organization as follows: **Larry J. French**, Director, Photomask Technology; **Larry J. Gallace**, Project Manager, IC Quality and Reliability Programs; **Heshmat Khajezadeh**, Director, IC Manufacturing Operations; **Richard L. Sanquini**, Director, IC Product Marketing; **John E. Schaefer**, Director, Government and Hi Reliability IC Products; **Joseph H. Scott**, Director, IC Technology; **Carl R. Turner**, Acting IC Engineering; and **Norman C. Turner**, Manager, IC Operations Planning.

Richard W. Ahrons, Manager, Memory and Microprocessor Product Marketing and Support Engineering, announced the organization as follows: **Richard W. Ahrons**, Acting Manager, Product Marketing—Microprocessor Systems; **Michael V. D'Agostino**, Manager, Product Marketing—Memory and Microprocessor Components; **Edwin M. Fulcher**, Manager, Microprocessor Systems Engineering; and **A.A. Key**, Leader, Technical Staff—Memory and Microprocessor Component Applications Engineering.

David S. Jacobson, Manager, Photomask Technology and Operations, announced

the organization as follows: **Robert A. Geshner**, Manager, Advanced Mask Technology; **David S. Jacobson**, Acting Manager, Photomask Tooling Production; **Ronald M. Melewski**, Manager, Photomask Production Control; **Robert L. Van Asselt**, Leader, Technical Staff, Photomask Quality Assurance; and **Evan P. Zlock**, Manager, Mask Production.

RCA Laboratories

Nathan L. Gordon, Staff Vice President, Systems Research, announced the organization as follows: **David D. Holmes**, Director, Television Research Laboratory; **James L. Miller**, Director, Manufacturing Systems and Technology Research Laboratory; **Roland N. Rhodes**, Staff Advisor; and **Alfred H. Teger**, Director, Advanced Systems Research Laboratory.

William M. Webster, Vice President, RCA Laboratories, announced responsibility for research and development on the VideoDisc

player is assigned to **Nathan L. Gordon**, Staff Vice President, Systems Research. Reporting to **David D. Holmes**, Director, Television Research Laboratory for the VideoDisc player will be: **Jon K. Clemens**, Head, Signal Systems Research; and **Eugene O. Kelzer**, Head, Video Recording Research.

Robert D. Lohman, Director, Display Systems Research Laboratory, appointed **Robert W. Shisler**, Manager, Advanced Development—Yokes, Technology Transfer Laboratory.

Commercial Communications Systems Division

Carleton H. Musson, Manager, Transmitter Equipment Engineering and Product Management, Broadcast Systems, announced the appointment of **Robert M. Unetich** as Manager, Television Transmitter Engineering.

Global Communications

Eugene F. Murphy, President, RCA Global Communications, Inc., announced the organization as follows: **Robert J. Angliss**, Executive Vice President, Switched Services; **Lawrence M. Codacovi**, Vice President, Leased Facilities and International Affairs; **Donald R. Stackhouse**, Vice President, Operations; **Joe T. Swalm**, Chief Engineer, Engineering; **Francis J.H. DeRosa**, Vice President and General Counsel, Law and Regulatory Affairs; **Robert V. Luongo**, Vice President, Finance; **Charles H. Twitty**, Vice President, Industrial Relations; **Leonard W. Tuft**, Vice President, Corporate Affairs; and **Thomas J. Brady**, Vice President, RCA Globcom Systems, Inc.

Joe T. Swalm, Chief Engineer, announced the organization as follows: **James R. McDonald**, Manager, Systems Engineering; **John P. Shields**, Manager, Project Engineering; **Louis P. Correard**, Manager, Standards and Documentation; **Solomon J. Nahum**, Manager, Construction and Engineering Services; and **Alexander A. Avanesian**, Staff Engineer.

Two RCA engineers elected IEEE Fellows

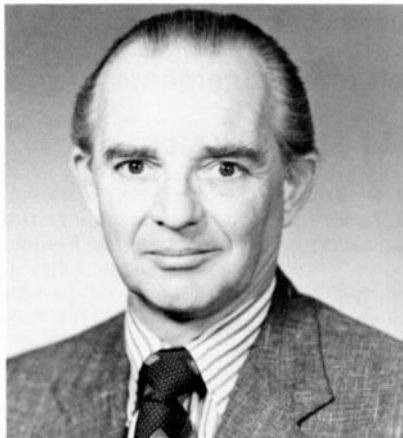

The membership grade of Fellow is the highest attainable in the Institute of Electrical and Electronic Engineers. The IEEE annually recognizes as Fellows those members who have made outstanding contributions to the field of electronics.

J. James Gibson

"for contributions to consumer electronic systems and solid-state circuits."

Mr. Gibson joined the Laboratories in 1956 and was appointed a Fellow of the Technical Staff in 1969. He has worked on a variety of projects related to broadcast systems, solid-state circuits, and consumer electronics. His current research is largely related to the RCA VideoDisc system. He received RCA Laboratories Outstanding Achievement Awards in 1960, 1961, and 1965, has published numerous papers in the fields of antennas, circuits, and systems, and holds one Swedish and 14 U.S. patents.



Willard T. Patton

"for contributions to the development of phased-array antenna technology."

Dr. Patton has been with Missile and Surface Radar since 1962, and is now Manager, Advanced Antenna and Microwave Technology. He has contributed several significant new array concepts, but is best known for his initial conception and direction of phased-array antenna development. This work brought the David Sarnoff Outstanding Technical Achievement Award to Dr. Patton and his team members in 1975.

Editorial Representatives

Contact your Editorial Representative, at the extensions listed here, to schedule technical papers and announce your professional activities.

Commercial Communications Systems Division

Broadcast Systems

BILL SEPICH* Camden, N.J. Ext. 2156
KRISHNA PRABA Gibbsboro, N.J. Ext. 3605
ANDREW BILLIE Meadow Lands, Pa. Ext. 6231

Mobile Communications Systems

KARL NEUMANN* Meadow Lands, Pa. Ext. 6444

Avionics Systems

STEWART METCHETTE* Van Nuys, Cal. Ext. 3806
JOHN McDONOUGH Van Nuys, Cal. Ext. 3353

Cablevision Systems

JOHN OVNICK* N. Hollywood, Cal. Ext. 241

Government Systems Division

Astro-Electronics

ED GOLDBERG* Hightstown, N.J. Ext. 2544

Automated Systems

KEN PALM* Burlington, Mass. Ext. 3797
AL SKAVICUS Burlington, Mass. Ext. 2582
LARRY SMITH Burlington, Mass. Ext. 2010

Government Communications Systems

DAN TANNENBAUM* Camden, N.J. Ext. 3081
HARRY KETCHAM Camden, N.J. Ext. 3913

Government Engineering

MERLE PIETZ* Camden, N.J. Ext. 2161

Missile and Surface Radar

DON HIGGS* Moorestown, N.J. Ext. 2836
JACK FRIEDMAN Moorestown, N.J. Ext. 2112

Solid State Division

JOHN SCHOEN* Somerville, N.J. Ext. 6467

Power Devices

HAROLD RONAN Mountaintop, Pa. Ext. 633-827
SY SILVERSTEIN Somerville, N.J. Ext. 6168

Integrated Circuits

FRED FOERSTER Somerville, N.J. Ext. 7452
JOHN YOUNG Findlay, Ohio Ext. 307

Electro-Optics and Devices

RALPH ENGSTROM Lancaster, Pa. Ext. 2503

Consumer Electronics

CLYDE HOYT* Indianapolis, Ind. Ext. 5208
FRANCIS HOLT Indianapolis, Ind. Ext. 5217
PAUL CROOKSHANKS Indianapolis, Ind. Ext. 5080
STEVE RACE Indianapolis, Ind. Ext. 5636
DON WILLIS Indianapolis, Ind. Ext. 5883

SelectaVision VideoDisc Operations

ROBERT MOORE Indianapolis, Ind. Ext. 3313

RCA Service Company

JOE STEOGER* Cherry Hill, N.J. Ext. 5547
RAY MacWILLIAMS Cherry Hill, N.J. Ext. 5986
DICK DOMBROSKY Cherry Hill, N.J. Ext. 4414

Distributor and Special Products Division

CHARLES REARICK* Deptford, N.J. Ext. 2513

Picture Tube Division

ED MADENFORD* Lancaster, Pa. Ext. 3657
NICK MEENA Circleville, Ohio Ext. 228
JACK NUBANI Scranton, Pa. Ext. 499
J.R. REECE Marion, Ind. Ext. 5566

Alascom

PETE WEST* Anchorage, Alaska Ext. 7607

Americom

MURRAY ROSENTHAL* Kingsbridge Campus, N.J. Ext. 4363

Globcom

WALT LEIS* New York, N.Y. Ext. 3655

RCA Records

JOSEPH WELLS* Indianapolis, Ind. Ext. 6146

NBC

BOB MAUSLER* New York, N.Y. Ext. 3589

Patent Operations

JOSEPH TRIPOLI Princeton, N.J. Ext. 2992

Research and Engineering

Corporate Engineering

HANS JENNY* Cherry Hill, N.J. Ext. 4251

Laboratories

MAUCIE MILLER Princeton, N.J. Ext. 2322
LESLIE ADAMS Somerville, N.J. Ext. 7357

*Technical Publications Administrator, responsible for review and approval of papers and presentations.

RCA Engineer

A technical journal published by Corporate Technical Communications
"by and for the RCA engineer"

Printed in USA

Form No RE-24-4