

tED

the ELECTRICAL DISTRIBUTOR



CURRENT
A CORNER
ON COPPER

BUSINESS
THE PROMISE
OF THE IDW

SPECIAL REPORT
SUCCESSFUL
SUCCESSION
PLANNING

[Ken Stier. (Dec. 01, 2014). Cornering the copper market, Red Kite Group, Lord Michael Farmer, pp. 20-23, PDF pp. 22-25. Commodities, Ted Magazine. Reproduced for educational purposes only. Fair Use relied upon. Source: <https://www.tedmagazine-digital.com/9de34181e518f0c7bc9f2ff84cb79c/6303afc7/pp/tedmagazine201412-14793389720004fbdf27d0b-pp.pdf>]

[[Click here](#) to go directly to "Cornering the copper market, Red Kite Group, Lord Michael Farmer, pp. 20-23]



**PRODUCT
PREVIEW:**
10 Trends to Watch
in 2015

BUSHINGS REDEFINED.



**MIGHTY-RITE® SPLIT BUSHINGS
DO MORE THAN JUST PROTECT CONDUCTORS.**



¾ TO 4-INCH TRADE SIZES



2 TO 4-INCH TRADE SIZES



¾ TO 4-INCH TRADE SIZES

NO MORE BURNING THROUGH BUSHINGS OR FIGHTING WITH PULLERS.

Install your bushings after pulling wire. MIGHTY-RITE's innovative hinge adjusts and aligns easier – even in tight spots. Our adjustable lay-in lugs position conductors for easy alignment and access; and our self-aligning latches provide a simple, one-handed install. That's the new definition of bushing innovation. Only from Bridgeport.

See the Difference a bushing can make on your next job.

Recent Awards:



 **BRIDGEPORT**
www.bptfittings.com

For more information visit tEDmag.com/InfoCard



**THE BRIDGEPORT
FITTINGS DIFFERENCE**



SCAN TO WATCH OUR
SPLIT BUSHINGS VIDEOS

TOTAL PACKAGE.

Get the job done right start to finish.



PRE-CONSTRUCTION



POWER DISTRIBUTION



BRANCH CIRCUIT



LOW VOLTAGE

The Power of Connections.™

#SOUTHWIRE | Connect With Us



Southwire®

©2014 Southwire Company, LLC. All Rights Reserved.

®Registered Trademark and ™Trademark of Southwire Company, LLC.

For more information visit tEDmag.com/InfoCard



Dec. 14

Features

NEW PRODUCT PREVIEW

66 10 Product Trends to Look for in 2015

Electrical product manufacturers tell us what will be trending in 2015—followed by 14 pages of some of the hottest products hitting shelves.

by **Susan Bloom**

SPECIAL REPORT

86 Succession Planning Takes Talent

Taking steps to retain your best and brightest is key to successful succession planning in an industry struggling to find qualified candidates.

by **Lisa Anderson**

90 Is Your Family Business Ready for the Future?

Because choosing the right successor is all about job suitability, here's a different take on family business succession planning.

by **Howard Coleman**

EasyLED

Because choosing
LED LIGHTING
shouldn't be difficult.



Maximum Optical
Performance.

Superior Thermal
Management.

Professional Grade.



Built for the
real world.
Keep it Easy,
Keep it Simple.

DuraGuard
PRODUCTS INC.
A QSSI Company
Lighting Your Way Since 1989

For more information visit us at
duraguard.com/EasyLED

800-736-7991



20
Cornering the
copper market



26
Fight back with
better procedures



24
Accelerated
growth



30
A capital
investment



46
Customer service
affects loyalty

Dec. 14 Departments

CURRENT

13 Market Outlook

Indicators suggest that construction is picking up overall, which is great for electrical distributors that depend on the construction industry—but the gains remain spotty by sector.

20 Commodities

Is there reason to fear that the London-based hedge fund, Red Kite Group, is trying to corner the copper market?

24 Research Review

A third-quarter Baird Survey finds accelerated growth and an upbeat attitude going into the fourth quarter and 2015.

26 Channel Issues

How better warehouse procedures can help in the fight against Amazon Supply and other nontraditional competitors.

30 Clean Industry

An LED lighting upgrade at a renowned hotel ensures a brighter and more sustainable stay in the nation's capital.

BUSINESS

41 How-To

Take advantage of what other companies have already learned about social/digital media and make 2015 a great year.

46 Branch Basics

In this competitive economy, loyal customers are critically important assets that a distributor can't afford to lose.

48 Clause & Effect

Understanding lien waivers in the construction industry.

SELLING

55 Market Focus

Higher education demands sustainability—and proof.

60 Selling Smart

The best salespeople develop both the hard and soft side of their selling approach—and understand which to use when.

62 Best of the Best Coverage

A pair of winning Direct Promotion entries and four engaging Events make up this month's 2014 awards coverage.

ALSO IN THIS ISSUE 6 President's Note | 8 Chair's Column | 10 What's on tEDmag.com | 14, 42, 56 Industry News | 16 Quarterly Product Report | 18 Contractor Q&A | 32 LED Update | 34 Happenings | 52 IDEA Update | 53 On the Bookshelf | 92 Ad Index | 94 People | 96 Publisher's Note

Lutron sensors make your job easier

Control all load types with a full line of in-wall sensors

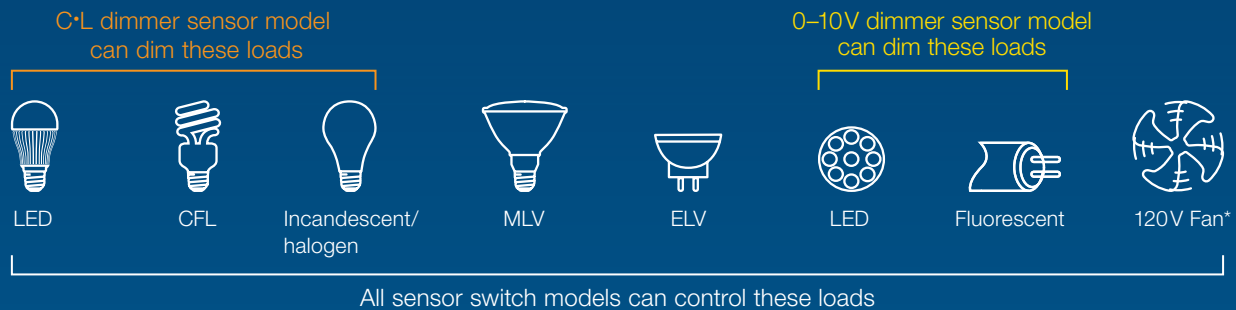

*2A PIR sensor switch is for lighting loads only

Easy installation

- Works right out of the box—default settings optimized for most common applications
- Easily adjust settings with no DIP switches or dials
- Miswire protection
- No neutral required

Products that work

- XCT™ sensing technology recognizes the difference between fine human motion and background noise
- Smart ambient light detection learns user's preferred light level and keeps lights off when sufficient daylight is available
- Extended relay lifetime and tamper-resistant lens

©2014 Lutron Electronics Co., Inc. | P/N 306-0114 REV A



For more information, visit www.lutron.com/sensors
Order now at your electrical distributor

For more information visit tEDmag.com/InfoCard

2014: a year in review

by Tom Naber

We've had a very productive year at NAED, and I'd like to highlight some of our major accomplishments. I look forward to building on these successes next year.

- The Women in Industry Forum, held in June, experienced a 38% increase in attendance with a 9% increase in the number of companies that participated compared to 2013.

- In April, we launched several Spanish online courses, including Bottom Line Basics and a VIP Spanish Training Bundle.

- The Foundation's Annual Campaign ended June 30; the total amount raised was \$255,000.

- The fourth annual Congressional Fly-In took place in September. More than 45 members of NAED conducted 156 meetings on Capitol Hill with members of Congress and their staffs.

- Four new research projects were published (visit naed.org/research for details about the NAED Education & Research Foundation's research).

- Branch Management University enrolled 60 new students (17 of whom are from Canada and one of whom is from Mexico) and 17 new companies.

- The AdVenture Marketing Conference, which was held in August, had a 5% increase in attendance over 2013.

- The Electrical Products Education Course (EPEC) was updated to include, among other things, the most up-to-date versions of the *National Electrical Code* and the *Canadian Electrical Code*.

- In partnership with Electro-Federation Canada, NAED launched the EPEC French Silver course.

- The October 2014 Women in Industry Bootcamp exceeded registration expectations by more than 14% and sold out in record time.

- The Repfiles NAED edition app was released in August.

- The Certified Electrical Professional (CEP) program continues to grow with 74 new CEPs for Inside Sales, 64 new CEPs for Outside Sales, and 54 recertifications.

I want to wish you a wonderful holiday season. Be sure to look for many incredible things from NAED in 2015. ■



Naber is president and CEO of NAED. He can be reached at tnaber@naed.org.



SUBSCRIBE TO TOM NABER'S "PRESIDENT'S BLOG" AT NAED.ORG.

PUBLISHER Scott Costa
scosta@naed.org

EDITOR Misty Byers
mbyers@naed.org

ART DIRECTOR Randi Vincent
rvincent@naed.org

PRODUCTION EDITOR Karen Linehan
klinehan@naed.org

WEB CONTENT MANAGER Nicky Herron
nherron@naed.org

EDITORIAL & WEB ASSISTANT Marie Jakle
mjakle@naed.org

CIRCULATION ADMINISTRATOR Stephanie Wobbe
subscriptions@naed.org

CONTRIBUTING WRITERS

Lisa Anderson, Susan Bloom, Darlene Bremer, John Chapin, Howard Coleman, Craig DiLouie, Dick Friedman, William Lynott, Jan Niehaus, Dan Nitowsky, Joe Nowlan, Katrina Olson, Jim Romeo, Ken Simonson, Ken Stier, Scott Wolfe Jr.

ADVERTISING

East-Central Region: Rich Ryan
P.O. Box 102, Port Clinton OH 43452
(419) 734-5545, Fax: (810) 958-0475
email: rgrsvc@gmail.com

Western Region: Steve Wafalosky
512 East Washington Street
Chagrin Falls, OH 44022
(440) 247-1060, Fax: (440) 247-1068
email: stevew@larichadv.com

Southern Region: Gary Lindenberger, Lori Gernand
7007 Winding Walk Drive, Suite 100
Houston, TX 77095
(281) 855-0470, Fax: (281) 855-4219
email: gl@lindenassoc.com; lg@lindenassoc.com

Southeast Region: Doug Fix
590 Hickory Flat Road, Alpharetta, GA 30004
(770) 740-2078, Fax: (678) 405-3327
email: dfix@bellsouth.net



AWARDS



missouri association of publications



Copyright © 2014 by National Association of Electrical Distributors, Inc. All rights reserved. Reproduction in whole or in part without written permission is strictly prohibited.

Simple, affordable controls for all applications.



Lighting Controls | Surge Protection | Weatherproof | Photo Controls | Sensing Solutions

Intermatic offers contractors solutions designed for easy installation, effective control, and reducing energy use in one building or across a campus. From electronic photo controls for LED street lighting to automated indoor/outdoor controls for retail locations to office buildings, Intermatic gives contractors great solutions.



Contact us at intermatic.com

©2014 Intermatic Incorporated



For more information visit tEDmag.com/InfoCard



Revisiting the subject of SPAs

by Maureen Barsema

In September, I wrote about Special Pricing Authorization (SPA) contracts, but this is such a significant topic that I want to revisit it and go into further detail.

When properly deployed and monitored, SPA contracts offer distributors and manufacturers an opportunity to meet competitive situations in the marketplace and enhance competition. Given the multitude of channel partners that each distributor and manufacturer deals with and the different SPA processes employed by each of them, the channel devotes a considerable amount of time and resources to processing SPAs. It stands to reason that if all channel partners were to standardize and streamline the SPA process, costs could be removed from the channel and competition would be enhanced.

Over the years, NAED has put together two SPA Task Forces. In 2005, the task force produced a white paper on best practices. A second task force was created in 2011 to continue to work toward a solution. This task force identified 37 pages of inefficient processing concerns despite the published best practices published years ago. Talk about an opportunity to evolve to something greater—and NAED set out to do just that.

The four strategic goals set to improve the SPA process, reduce costs, and enhance competition were:

1. Standardize industry terminology
2. Standardize the format of SPAs

3. Automate SPA transmission and processing

4. Prevent common discrepancies

In August, *tED* conducted a survey of electrical distributors about SPAs. Nearly 80% of those surveyed responded that no manufacturer currently offers a rebate/claim process that could be adopted as an industry standard. Why do we make conducting business with one another so difficult? It's frightening to think about the cost of this waste. In the end, we can make a lot more money by working together to reduce costs and deploy an industry solution.

So what do distributors think a standardized process should look like? According to the survey, the parts of the current rebate systems considered to be best practices include turnaround time/timely payment (16%), automated entry (9%), ease of use (7%), and reconciliation (5%).

To help promote SPA standardization, the SPA Task Force created an SPA Process Accreditation Program. NAED launched this program by gathering key electrical distributors, each of which evaluated key manufacturers. Once completed, working sessions will be scheduled to help individual manufacturers implement the recommended best practices and make the SPA process more efficient for all parties involved. Adopting these best practices would certainly go a long way toward improving the current SPA rebate process by making it more efficient.

All of this got me thinking. In addition to standardizing the current rebate

process, we should also be thinking about adopting a common rebate platform that establishes an efficient methodology that allows both distributors and manufacturers to measure the effectiveness and performance of their SPA contracts. Such an SPA platform should include:

- The ability to closely monitor actual SKU purchase and sale activity on any given SPA contract
- The ability to add new products to (or delete nonperforming products from) an existing SPA contract
- The ability to compare pricing levels among similar customers to ensure consistent and effective pricing strategies
- The ability to provide sales personnel with the data they need to meet with their customers to share and discuss actual contract performance
- The ability to determine the inventory levels needed to support actual SPA contract performance
- The ability to provide (at any time) the average on-hand carrying cost of the unsold stocked product

In an industry where competition is fierce, can we afford not to reduce costs and make the SPA process more efficient? I have received many comments on this topic from industry partners, and I encourage you to participate in a solution and make a difference. ■

Barsema is vice president, business administration, Revere Electric Supply, Chicago, and former vice president and CFO of BJ Electric Supply, Madison, Wis. Reach her at maureenb@bjelectric.com.



GET INVOLVED IN OUR ONLINE COMMUNITIES BY FOLLOWING US ON TWITTER: @NAED_ORG AND @TEDMAGAZINE.



MANUFACTURED IN AMERICA

TO BUILD AMERICA

General Cable's high-quality copper building wire and Carol® Brand cord are manufactured in America and installed in many commercial and institutional buildings across the U.S.

Offering a total building wire solution that features the new **High Speed** line of copper building wire, General Cable provides cutting and paralleling services as well as pulling eyes for easy installation. Our rugged Super Vu-Tron® Supreme SJOOW and SOOW cord products are designed to withstand severe environmental conditions in both permanent and temporary power applications.

We are committed to providing the products you need when you need them. Place an order for copper building wire that meets the freight minimum, and General Cable will waive freight charges for Carol Brand cord products placed on the same order.

Go all-in and contact your local General Cable sales representative to take advantage of our bundled freight offer today!



 **General Cable**

www.generalcable.com 1.800.243.8020

For more information visit tEDmag.com/InfoCard

BONUS CONTENT



BONUS FEATURE

Three steps that keep a sale moving forward

This month's bonus feature follows the story of Steve, a salesperson who was frustrated because he was encountering the same problem over and over: He would have successful meetings with prospects who expressed interest in his products. They would ask lots of questions and appear genuinely interested in doing business with him. At the end of the meetings, the prospects would tell him to reach out in a few weeks when things have settled down. But when Steve called them—several times over the next month—he didn't get any responses.

Learn how to avoid suffering the same fate as Steve and keep your sales moving forward in the "Bonus Content" section of tEDmag.com.

PRODUCT SHOWCASE

More new products for 2015

This year's New Product Preview starts on page 70 and runs for 14 pages—but if that's not enough, check out our online gallery of even more new products being introduced just in time for the new year. Find them in the "Bonus Content" section of tEDmag.com.

© THINKSTOCK

»DISCOVER THE NEW tEDTV

tED magazine is happy to announce the relaunch of tEDTV, the improved video site that now connects the entire supply chain like never before. Check out the latest videos from NAED member companies—or submit your own videos—at tedtv.tedmag.com.

»DOWNLOAD THE tED MAGAZINE APP

All the news, columns, features, and information found each month in tED fit in your pocket—get the app for free from Google Play and the App Store.

KEEP IN TOUCH ONLINE...

»FACEBOOK

 We're working on our social media every day. Now is the time for you to "Like" the tED magazine Facebook page. Visit our page, click "Like," and join in the conversations.

FIND US AT:
[facebook.com/tEDmagazine](https://www.facebook.com/tEDmagazine)

»TWITTER

 Participate in our Twitter chats the second Monday of each month. Simply log on to Twitter at 1 p.m. CST and send tweets with #tEDchat at the end to track the conversation.

FOLLOW OUR TWITTER FEED: [@tEDmagazine](https://twitter.com/tEDmagazine)

»EMAIL

Do you have news to share? Are you connected to the people who can help you get it in tED magazine or on tEDmag.com? Send your press releases to tED magazine Editor Misty Byers at mbyers@naed.org or tEDmag.com Online Editor Nicky Herron at nherron@naed.org.

»TEDMAG.COM

tEDmag.com is your go-to source for the latest industry news and headlines. Updated daily, tEDmag.com features headlines on distributor, manufacturer, and people news, as well as commodity information, industry perspective from our bloggers, and more.

SAVE TIME...FAST, EASY **PUSH ON** INSTALLATION

PUSH-ON CONNECTORS

FOR NON-METALLIC LIQUID-TIGHT CONDUIT



NO TOOLS!



DONE.

PUSH ON
installation

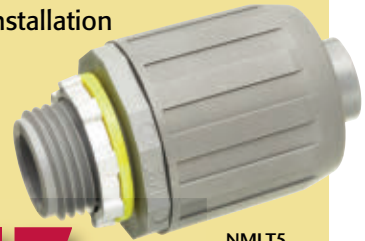

17 seconds
per connector

VS

Conventional
installation



57 seconds
per connector

SAVE 40 seconds or *33¢ per push-on connector!

Arlington's push-on connectors offer the fastest, easiest way to install non-metallic liquid-tight conduit, type B.

Our one-piece connectors reduce labor steps and eliminate lost pieces. They ship fully assembled with no disassembly needed – and are removable and reusable.

Save time and money with our user-friendly, straight and 90° push-on connectors.

*at \$30.00/hour labor rate

View Video



NMLT905

NON-METALLIC

Catalog Number	Trade Size	Straight	90°
NMLT5	1/2"	✓	
NMLT905	1/2"		✓
NMLT7	3/4"	✓	
NMLT907	3/4"		✓
NMLT10	1"	✓	
NMLT9010	1"		✓

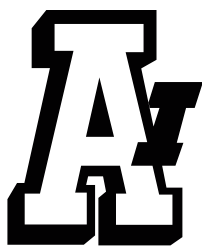

Arlington



Made in USA

www.aifittings.com Scranton, PA 18517 800/233-4717

Patented.

For more information visit tEDmag.com/InfoCard

©2012 Arlington Industries, Inc.

tEDmag.com is pleased to announce the *relaunch* of tEDTV

TEDTV MAKES IT SIMPLE TO UPLOAD AND VIEW VIDEOS, BROADEN YOUR AUDIENCE, AND INCREASE YOUR CUSTOMER BASE.

The best library of product and technology videos to provide the industry with the place to go for everything you need to know.

We provide multiple ways to promote your video on our website:

- Featured videos
- Videos by category
- Sponsored videos

THE BENEFITS OF A FEATURED VIDEO:

- Promoted on the tEDmag.com homepage
- Presented in the features section of tEDTV
- Given top billing in the video's category on tEDTV
- User-friendly for the supply chain (contractors, distributors, and manufacturers)
- Easy search functions

To submit a video, go to:
tedtv.tedmag.com



create • watch • learn • engage



Bright spots in a marred landscape

Construction prospects brighten, but dark patches remain.

by Ken Simonson

Electrical distributors that depend on the construction industry have more reasons to smile this fall as both concurrent and forward-looking indicators suggest construction activity is picking up overall. But the gains remain spotty by sector. For instance, “New construction starts in September advanced 10%” from the August level, adjusted for normal seasonal variation, McGraw Hill Construction (MHC) reported on Oct. 20, adding, “The increase followed an up-and-down pattern during the previous two months and brought activity to its highest level so far during 2014. Nonresidential building registered a sharp gain, helped by an elevated pace for several institutional categories plus another brisk month for manufacturing plants, while the nonbuilding construction sector also strengthened. Running counter in September was a decline for residential building.”

MHC Chief Economist Robert Murray commented, “The progress for construction starts has been uneven at times on a month-to-month basis, but the quarterly averages show that an upward trend has been re-established. In this year’s first quarter, construction starts fell back 10% but then climbed 6% in the second quarter and another 6% in the third quarter.”

Murray noted that a key factor in keeping the construction expansion going in 2014 has been the greater role now being played by nonresidential building.

“Commercial building has continued to see moderate growth from low levels, and the manufacturing building category is still showing a surge of chemical and energy-related plants reach groundbreaking,” he said.

“What’s different in 2014,” he continued, “is that the institutional structure types are now beginning to contribute to the nonresidential building upturn. In contrast, both public works and electric utilities have generally lost momentum during 2014, notwithstanding their strong showing in September. And residential building is now providing a much smaller lift than in the past two years, as the sluggish performance by single-family housing has

outweighed further gains by multifamily housing.”

A week earlier, CMD (formerly Reed Construction Data) reported that the value of nonresidential building and heavy/civil engineering starts in September jumped 30% from a year earlier. CMD said starts in the first nine months of 2014 combined were 10% higher than

“The progress for construction starts has been uneven at times on a month-to-month basis, but the quarterly averages show that an upward trend has been re-established.”

—Robert Murray, McGraw Hill Construction

in the first three quarters of 2013. CMD and MHC collect data independently.

A third favorable omen appeared on Oct. 22, in the form of the American Institute of Architects’s (AIA) monthly Architecture Billings Index. This gauge measures the percentage of responding architecture firms that reported an increase in billings from August to September, net of those reporting a decrease. Readings above 50 signal an increase in construction spending nine to 12 months ahead, according to the AIA.

The overall index registered 55.2, up from 53 in August and the fifth consecutive mark above 50. Firms with a predominantly residential practice—

INDUSTRY NEWS



► Brook purchases Platinum

Brook Electrical Supply, Chicago, has purchased Platinum Electrical Supply in Streamwood, Ill.

► North Coast grand opening

North Coast Lighting, Portland, Ore., a division of Seattle-headquartered North Coast Electric, has opened a new 7,400-square-foot showroom. A grand opening was held on Nov. 13.

► GE’s dual expansion

On Nov. 19, GE Industrial Solutions celebrated the grand opening of its Advanced Manufacturing Lab at its Plainville, Conn., headquarters. The company is also investing \$5 million to strengthen its Mebane, N.C., operations, adding production and testing capabilities that enhance the customer experience. Earlier in the month, GE Lighting’s Hendersonville, N.C., plant unveiled a new production area for the manufacture of LED circuit boards.

► A buy for Group CBS

Group CBS, with commercial interests in electrical supply, field service, and engineering throughout North America, has acquired Electric Control Equipment, an electrical equipment supplier and service provider headquartered in Norwalk, Conn.

► MaxLite’s new facility

MaxLite recently opened a new LEED-certified facility in Anaheim, Calif. The 48,864-square-foot building increases the company’s product assembly and testing capabilities and features its first full showroom on the West Coast.

For up-to-date industry news and information, go to tEDmag.com.

BEFORE THE FANS STARTED ROOTING FOR THEIR HOME TEAM, CONTRACTORS WERE CHEERING FOR TOPAZ



Topaz products can be found in America's most iconic construction projects.

... because we're the easiest company to do business with in the industry. With over 17,000 electrical and lighting products, our value and quality is unsurpassed as is our 99% order fill rate. With knowledgeable, responsive and friendly service, we deliver on time - even next day. Visit our new website www.topaz-usa.com so you can start cheering too!



www.topaz-usa.com • 800.666.2852 | 99% FILL RATE. NEXT DAY DELIVERY

ALABAMA • CALIFORNIA • FLORIDA • GEORGIA • MICHIGAN • MISSISSIPPI • MISSOURI • NEW YORK • OKLAHOMA • OREGON • PENNSYLVANIA • TENNESSEE • TEXAS

For more information visit tEDmag.com/InfoCard

generally multifamily—have now reported increased billings on net every month for three full years. Firms with a commercial/industry practice have been close to, but above, the breakeven 50 level for all of 2014. Firms with institutional and mixed practices reported positive billings for the fourth and fifth straight months, respectively.

MHC issues a similar measure, the Dodge Momentum Index, “a monthly measure of the first (or initial) report for nonresidential building projects in planning, which have been shown to lead construction spending for nonresidential buildings by a full year.” MHC reported on Oct. 7, “After rising 13% during the first half of 2014, the Momentum Index declined in each of [the] last three

months, retreating a combined 7%. Despite these setbacks, the Momentum Index remains 8% higher than a year ago, indicating that to this point the upward trend for nonresidential building projects at the planning stage is still present.”

For a finer-grained look at what types of construction are doing well, it is useful to examine the monthly report on “value put in place,” or spending on projects under way, that the Census Bureau issued on Oct. 1. The agency found that total construction spending was 5% higher in August than in August 2013. Private residential spending was up 6%; private nonresidential, 9%; and public construction, 2%.

Within these broad categories there were significant differences. New multi-

family construction was the standout, soaring 36% from year-ago levels. New single-family construction rose a tepid 4%, and improvements—additions and major renovations to existing residential structures—plunged 10%.

A separate Census report on housing starts and building permits, issued on Oct. 17, suggested that the divergent single- and multifamily trends will continue. Single-family starts climbed 11% from September 2013 to September 2014, while multifamily starts (in buildings with five or more units) jumped 30%. Building permits, a generally reliable indicator over time for future single-family starts, inched up .8% in the first nine months of 2014 compared to the same period of 2013, while

Quarterly Product Report

SAME-BRANCH SALES

ELECTRICAL DISTRIBUTION CHANNEL: PERCENT CHANGE VS. ONE YEAR AGO—ROLLING THREE MONTHS (DOLLAR BASIS)

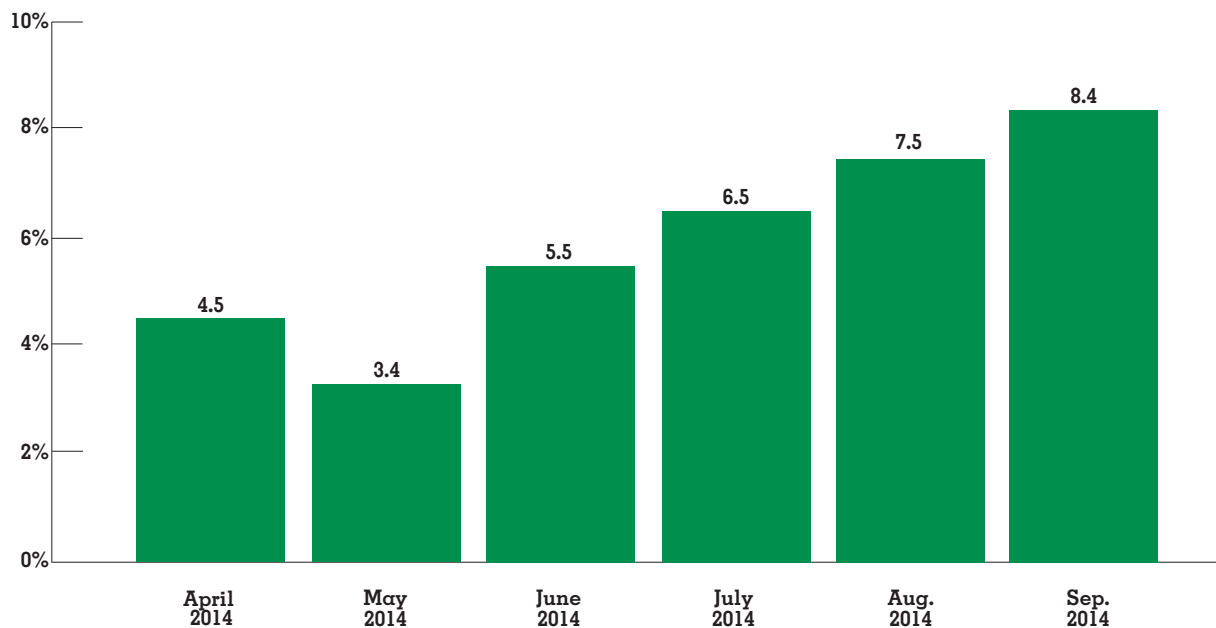

Calculation of total out-the-door sales percent changes within a unified panel of full-line electrical distributor branches. Using same-branch sales as an indicator, over the past six months, electrical product sales have increased by 7% over the same time period last year.

Sales tracking information is based on estimated sales from a representative sample of full-line electrical distributors located throughout the United States. **Source:** Vista Information Services; call 512-278-5800 or go to epicor.com/Vista-Information-Services.

IDENTICAL PRODUCTS?



ONLY **ONE** COMES FROM THE EASIEST COMPANY TO DO BUSINESS WITH.

Take the Topaz Challenge. You'll see our quality and price is equal to or better than most every brand in the market. Email ChallengeUs@topaz-usa.com and we'll send you any electrical fitting sample* to compare side-by-side with your current brands. Nobody makes business easier than Topaz.

*Some exceptions apply



www.topaz-usa.com • 800.666.2852 | 99% FILL RATE. NEXT DAY DELIVERY

ALABAMA • CALIFORNIA • FLORIDA • GEORGIA • MICHIGAN • MISSISSIPPI • MISSOURI • NEW YORK • OKLAHOMA • OREGON • PENNSYLVANIA • TENNESSEE • TEXAS

For more information visit tEDmag.com/InfoCard

multifamily permits increased 16%.

As for private nonresidential construction spending, there were double-digit year-over-year increases in each of the four largest segments, which together account for 70% of the category. The biggest niche, power construction—comprising oil and gas field and pipeline construction as well as power plants, renewables, and transmission lines—leaped 17% from August to August. Manufacturing construction gained 15%; commercial construction—retail, warehouse, and farm, in the agency's terminology—rose 10%; and office construction was up 19%.

Oil and gas field, pipeline, and related manufacturing projects are likely to keep growing rapidly in 2015, even if oil prices continue to sink. In fact, multi-billion-dollar "downstream" projects to deliver hydrocarbons from well sites to power plants, petrochemical complexes, and export terminals will generate demand for electrical components for years to come.

There will also be demand to expand capacity from manufacturers of every type of transportation equipment. Orders have mushroomed for cars, trucks, trail-

ers, rail cars, airliners, and barges. Selected other factories are also in the permitting or groundbreaking stage, ranging from a tire plant in South Carolina to Tesla's "gigafactory" to produce batteries in Nevada.

Demand for commercial and office construction may not be as strong as the Census numbers suggest, however. Those figures, unlike the residential data, do not break out new construction from renovations. Much of the retail construction appears to be tenant improvements as one retailer replaces another that closed up shop(s). Similarly, office construction includes renovations to accommodate the smaller offices and open floor plans many tenants now want or to improve the energy efficiency of older buildings. These projects generate business for electrical distributors but not necessarily as much as new construction.

More than half of public construction spending comes from two segments: highway and street construction, which was flat over the 12 months ending in August, and educational construction, which rose 3%. Electrical distributors should not expect any improvement in

those percentages in the next year. In fact, highway construction is at risk of a steep contraction after next May, when the current federal highway aid legislation, known by the acronym MAP-21, will expire.

Educational construction may finally have stemmed its years-long descent, but the Census Bureau reported on Sept. 24 that enrollment at two- and four-year colleges and universities decreased for the second year in a row in 2013. The two-year decline was the largest since the series began in 1966. It reflects the downturn in the high-school-age population and a reaction against the high levels of debt many college students take on. Meanwhile, school districts have sharply cut their construction budgets as prerecession bond issues have been used up.

Thus, there are many bright spots for electrical distributors contemplating the near-term construction market. But several large dark patches mar the landscape as well. ■

Simonson is chief economist for the Associated General Contractors of America. Reach him at ksimonson@erols.com.

Contractor Q+A

To better help electrical distributors respond to the needs of electrical contractors, "Contractor Q&A" features remarks from real contractors from around the country. This month, Frank Bartlett, president and owner of Pace Electrical Contractors in Savannah, Ga., and Larry Howell, former vice president and co-owner of the company, answer the question: **What is the one thing you wish your electrical distributor could/would do for you?**

Bartlett: "I have more trouble getting consistent pricing at branches of national and regional distributors. It's an occurrence where we didn't send the correct amount of materials to the jobsite so somebody has to run to the distributor or we have to call a smaller order in, and we have blanket pricing on that equipment. The benefit for the contractor is that it gets consistent pricing at whatever branch it goes to. And while in theory that sounds good, in practice it doesn't seem to work that well."

"City Electric Supply is one of the best at it because it operates smaller multiple branches and it has a tendency to check back with a central office before sending out invoices to us. We try to do the same with some other distributors, but it just doesn't work out the same way. [Pricing discrepancies] take a lot of extra time with my payable department in that invoices get kicked out because they don't match purchase orders and have to be reprocessed by another person and then resent to the payable department, which is a large expense for a contractor. When POs, invoices, and tickets match up, it's automatic for us and a win-win for all."

Howell: "The problem can be solved as usually these blankets are fairly profitable for the distributor; it's just their implementation. Because it is not a daily problem, we don't track it. A lot of contractors have arrangements for blanket purchasing, and a solution can be found." ■

Send your questions to "tED" Editor Misty Byers at mbyers@naed.org.



WHY
nsi
INDUSTRIES



© SAVAS KESKINER/ISTOCK

A corner on the copper market

Late October brought the news that the Red Kite Group held as much as 90% of the “live” copper in LME warehouses. Is there reason to fear that this London hedge fund is trying to corner the market? **by Ken Stier**

Alarm bells went off when business press reports emerged in late October that a sole entity—generally believed to be the Red Kite Group, one of the world’s largest metals merchants—held as much as 90% of the “live” copper in London Metal Exchange (LME) warehouses, sparking fears that this London hedge fund was trying to corner the market. Although the LME inventory is only about 10% of the total global supply, it has an outsized influence as a benchmark for spot prices, which carry premiums for those needing to take immediate physical possession of the red metal. Premiums for LME copper have been rising, reaching their highest levels in years, and there is concern that if LME inventory remains tight—stocks in late October (roughly 162,625 metric tons) were less than half where they stood in January—premiums might continue to rise from the ~\$75 per tonne level.

Commodity markets are periodically plagued by price-squeezing maneuvers despite exchange rules designed to thwart such leveraging. For its part, the LME insists that such large positions are not that unusual for base metals—although more often they are taken by large banks—and that they have “lending guidance” rules that kick in with positions of 50% or more to prevent profiteering.

Just how effective these measures are is difficult to judge because of their ar-

**We take our best ideas
and make them yours.**

Learn more about our focus on ingenuity at www.leviton.com/values

For more information visit tEDmag.com/InfoCard

cane mechanics and what one expert calls the “hall of mirrors” nature of the exchange. Many analysts, though, say the alarm is unwarranted. “It happens all the time for various base metals and the LME has rules in place to deal with it,” noted Catherine Virga of the CPM Group. “The LME member [taking the long position] could be JP Morgan and represents the interests of thousands of

its clients, or as rumors suggest it could be Red Kite, [but] it doesn’t necessarily mean Red Kite is trying to corner the market.”

Red Kite, she argued, has a far broader interest in the overall copper market—pointing to the firm’s substantial, though less known, role through RK Mine Finance subsidiary in underwriting a wide range of mining projects.

In some transactions involving copper mines, Red Kite is compensated by off-take agreements. That might even prove to be the more profitable side of their business. “It puts its money in and then its kicker is really in the off-take of the material when the mine comes into play; that’s really where it makes its money,” said a veteran U.S. metals trader who requested anonymity.

That adds a new dimension to the formidable trading reputation of Red Kite and its principal, Michael Farmer, a near-legendary figure in metals trading circles, with half a century of copper experience (decades before it became a mainstream asset class). Indeed, Farmer’s whole life has been in copper. When his father, director of an LME ring dealer AJ Strauss, died, the firm paid for Farmer’s schooling and gave him his first job. He was mentored by other trading luminaries and led several outfits before starting Red Kite in 2005 with \$24 million; it currently has \$2.3 billion under management.

Red Kite was the first hedge fund active in China, which consumes 40% of global copper, and was reportedly supplying the world’s second-largest economy with 15% to 20% of its copper needs, and its involvement in the physical market provides invaluable market intelligence that can provide decisive trading advantage. For example, in 2008, after a Chinese contract party just receiving a shipment suddenly asked to cancel the deal, Farmer took that as a sign of impending trouble—months before the crash, he explained in a March 2014 *Metals Bulletin Magazine* profile.

Previously known as “Mr. Copper,” Farmer had a “working peerage” bestowed on him this past August, elevating him to Britain’s unelected House of Lords, where now as “Lord Copper” he said he hopes to influence market reforms. “The experience of being an active Christian involved in the markets can be of use in defining good practice,” he told Reuters.

“Jesus warns us that there are many dangers to money,” the evangelical Christian told a Bloomberg reporter, who

WIREMOLD® OVERFLOOR RACEWAY

CONNECT YOUR CONTRACTORS TO AN OFF-THE-WALL INNOVATION.



Off-the-wall innovation for your contractors. OFR Series Overfloor Raceway is the fastest growing raceway product from Legrand. Requiring only 15 SKU’s for a complete and simple installation, the raceway features a low profile and brings power, communications and A/V services off the wall to open spaces. Learn more at legrand.us/overfloor.

For more information visit tEDmag.com/InfoCard

designed to be better.™



listened to him sermonize at St. Helen's Bishopsgate, an 800-year-old church in London's financial district. "I know that in my heart there is greed; there is wanting just a little bit more. It helps that the Bible tells me to be wary of this and that one day I will fall off my perch," he said.

But after posting gains of 50% last year, Red Kite—named for a day-hunting raptor—is still soaring high. Analysts say the firm's commanding LME position also reflects a generally bullish view of copper. "I think there is a general consensus medium to longer term that the copper market is facing a supply issue [in 2017-2018], but where there is a little less certainty is in the near term," said Stefan Ioannou, a base metals analyst with Haywood Securities. "Either Red Kite has a much longer time outlook and it's willing to sit on physical copper for a while or it thinks the copper bears out there are wrong and we are going to see the price run up before it goes down in the shorter term."

The rationale for Red Kite's positioning would have been clear to anyone following industry press coverage. "We haven't seen the refined-copper market this tight since the 2005-2006 period," Red Kite Co-Founder David Lilley told Reuters in January. "Inventory is low, premiums are high, and there is difficulty in sourcing refined metal." In the *Metals Bulletin Magazine* interview, Farmer predicted that an expected surplus would be undermined by mine production problems and renewed buying by China's Strategic Reserve Bureau. "We haven't had a world-class mine discovered since Chile's Escondida, virtually 25 years ago," he added.

That proved prescient and dodged the flawed forecasting of the Lisbon-based International Copper Study Group (ICSG), which in April saw a 405,000-tonne surplus in global refined copper for the year. But its most recent semi-annual assessment, published Oct. 14, envisioned a 307,000-tonne deficit, which, according to Andy Home, one of the industry's most acute observers, "amounted to a spectacular statistical

U-turn"—one that seems sure to have put a smile on Farmer's face. To all the inherent difficulties of predicting a dynamic global metals market, Home, a Reuters columnist, added the off-exchange inventory found in China's bonded warehouses that have come to dwarf the transparently reported stocks. That reinforces his "key point...[that] there is no statistical 'truth' when it

comes to a market such as copper." Next year ICSG forecasts what Home says is the "first clearly visible surplus in six years." The question remains: How much are you willing to bet on it? ■

Stier is a New York-based reporter, editor, and communications professional with more than 25 years of experience. He can be reached at kenstier@earthlink.net.

PASS & SEYMOUR® NIGHT LIGHT DEVICES

CONNECT YOUR CONTRACTORS TO A BRIGHTER PATH FOR BUSINESS.



Give your contractors a guiding light. Since creating the original in-wall night light device, Legrand has continued to develop the latest innovations in nighttime accessories. With the full line of redesigned night lights, contractors can offer greater convenience, control, and safety for navigation in any dark setting. Learn more at legrand.us/night-light-dist.

For more information visit tEDmag.com/InfoCard

designed to be better.™

 **legrand**®



© ROBERT THYRONS/STOCKPHOTO

Respondents indicated that average year-over-year revenue growth in the third quarter was 4.8% in the electrical sector and 7.4% among datacom businesses, outpacing the 4.4% growth across the broader industrial distribution market, which is composed of 19 product lines. Growth for electrical firms came in slightly below the levels forecast last quarter (+5.5%), while datacom distributors outperformed expectations (+3.6% forecast).

Among electrical distributors, firms based in Canada reported higher revenue growth than those in other regions, which showed little variation. The Midwest was by far the strongest region for revenue growth among datacom respondents, while growth was roughly in line with overall trends in the South and Canada, with relatively weaker—but still solid—trends seen in the Northeast and West and internationally.

Average pricing in the third quarter rose 1.1% from a year earlier for electrical respondents, 1.3% among datacom panelists, and 1.1% across the broader industrial distribution market. Pricing trends were roughly unchanged from second-quarter levels, despite recent moderation in copper prices (which likely had a disproportionately negative impact on electrical trends). Price increases were clustered in roughly a 1% to 2% range in all regions, except for international firms, which reported negligible price increases.

Looking forward, survey respondents expect electrical revenue to continue growing at a 4.9% rate in the fourth quarter (virtually matching the third-quarter growth rate of 4.8%), with datacom growth at 5.5% (a deceleration from the 7.4% growth experience in the third quarter). These rates would again top the revenue growth of 3.8% forecast across the broader industrial distribution market.

Assuming these growth rates materialize, they would mark the highest level of fourth-quarter growth for electrical and datacom distributors since 2011. Full-year growth for both segments would be in the 3% to 4% range.

Revenue revs up

Third-quarter Baird Survey finds accelerated growth, upbeat attitude. **by Ken Simonson**

Revenue growth accelerated from the second quarter of 2014 to the third quarter, according to the 98 respondents to the third-quarter survey conducted by securities analyst Robert W. Baird & Co. in partnership with *tED*. Participants are also upbeat about revenue growth in the fourth quarter and 2015. Third-quarter gains were driven by both broadening nonresidential construction activity and improved trends for industrial and OEM segments. Collectively, participating firms' revenue totals approximately \$14 billion, with roughly equal representation from all regions of the United States (in addition to Canadian and international businesses) and range in size from under \$10 million in annual revenue to more than \$500 million. The number of responses expanded from 57 in the second quarter.

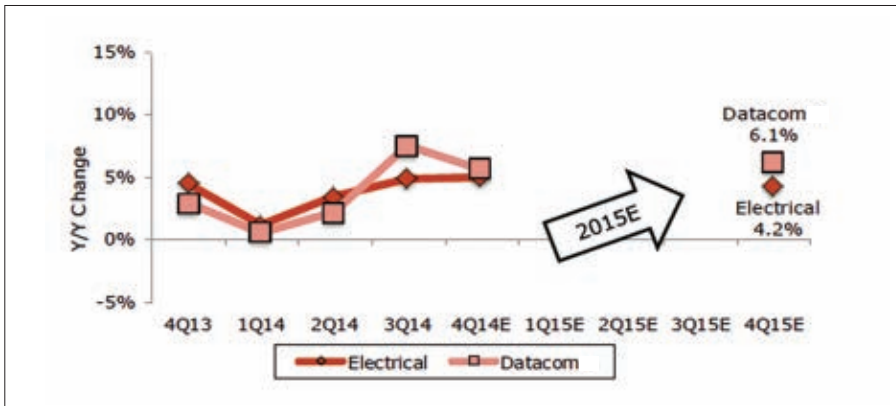

In their initial outlook for the full year 2015, respondents forecast revenue growth of 4.2% in electrical and 6.1% in datacom. This compares to 4.1% expected growth across the broader industrial distribution market.

Regarding the fourth-quarter outlook for inventory, electrical respondents forecast net inventory decreases in the fourth quarter at a similar rate to the previous year. Datacom respondents expect a more meaningful shift to destocking than seen in 2013.

In their initial outlook for the full year 2015, respondents forecast revenue growth of 4.2% in electrical sales and 6.1% in datacom. This exceeds anticipated results for 2014 as well as the 4.1% growth expected across the broader industrial distribution market. Electrical and datacom distributors in the Midwest are considerably more bullish about 2015 than their peers elsewhere, while international distributors foresee minimal growth next year.

The survey asked respondents how their customers' expectations of doing business with them have changed and how they are adapting their business to meet these new demands. Roughly 70% of panelists said customers expect more services. One panelist said the firm is "adding resources like product specialists." Another is "increasing warehouse storage capabilities and extended hours for deliveries and pickups." A third commented, "Many expectations require more services without adequate fees to offset. Working with customers that understand that relationship."

Nearly as many panelists said they are experiencing more price pressure. To adapt, one respondent is "working closer with manufacturing partners." A second said, "We have shifted our product mix away from commodity items." Another is "selling with more than just price, relationships, etc. Showing added value and service to earn customer trust and business." A fourth respondent is "sending the price shoppers away," while another reports "tightening prices on high-velocity items."

About 40% of respondents said they are making more product data available or offering online account information. Roughly 33% said they have been adding more product categories; about 10% reported making no significant changes.

Included in the survey were questions about the third-

quarter revenue and pricing growth for 19 product lines and overall, along with respondents' forecasts for fourth-quarter and 2015 revenue growth. The result: Datacom distributors' 7.4% third-quarter revenue increase was the steepest of any product line and they rank among the top three in their expectations for the fourth quarter and 2015. (However, Baird calls a "continued shift to larger data centers a longer-term secular negative" for datacom firms.)

Electrical product distributors expect their revenue growth in the fourth quarter (4.9%) to exceed the growth rates of all but three other product lines. In contrast, their expectations for

4.2% growth in 2015 are in the middle of the forecasts, although Baird remarks, "Nonresidential construction recovery expected to accelerate in 2015." ■

Simonson is chief economist for the Associated General Contractors of America. Reach him at ksimonson@erols.com.



Let Hammond Be Your Enclosure Supplier



Profit with the "Hammond Advantage"

- 95% Fill Rate
- NO Minimum Billing
- Low Prepaid Freight
- NO Inventory Risk

Contact Jim Sullivan
716.630.7030 | jsullivan@hammfg.com

hammondmfg.com

For more information visit tEDmag.com/InfoCard



Fight back with better warehouse procedures

Few electrical distributors can afford the warehouse automation used by nontraditional competitors—but all can take steps to ensure that orders are filled accurately, quickly, and at a low cost. **by Dick Friedman**

The mythical Ali Baba uttered “open sesame” to gain access to treasure, but manufacturers that sell on the Alibaba B2B trading site don’t need magic words to gain access to the treasure of customers of traditional electrical distributors. The modern-day Alibaba is no myth, and upon going public this past fall, it had some 279 million active buying customers, dwarfing Amazon Supply, Grainger, and others. This article describes some measures electrical distributors can take to ensure that their warehouses are operating cost-effectively enough to help compete against nontraditional competitors (many of whom use automated material handling).

MSC Industrial Supply, not normally thought of as a competitor, is a good example of a company that is using its warehouse as a competitive tool. (The company offers more than 20,000 electrical and lighting products). Orders re-

ceived by the cutoff time and not subject to restrictions are shipped that day. For an additional charge, “qualifying orders” taken by 8 p.m. ET can be shipped via air freight to the lower 48 states by the next business day.

KNOWN PROBLEMS

E-commerce “distributors” rarely make warehouse mistakes and operate very efficiently, so competing against them requires filling orders accurately, quickly, and at a low cost. If the warehouse mistake rate, the fulfillment rate, and the fulfillment cost are subpar, the time to improve them is now. Customer-detected warehouse mistakes (picking and delivery) should be fewer than one mistake per 1,000 lines picked. When everything that should be delivered by a promised date and time is delivered on time, the fulfillment rate is 100%.

If these three performance measures are not being tracked, create a form for

COMPETE BETTER WITH NONTRADITIONAL DISTRIBUTORS BY FILLING ORDERS ACCURATELY, QUICKLY, AND AT A LOW COST WITH “THE DISTRIBUTOR’S WAREHOUSE GUIDE—PREVENTING MISTAKES THAT HURT CUSTOMERS.” DOWNLOAD IT FOR FREE AT GENBUSCON.COM.



It's What's INSIDE That Counts!

Retrofitting your fixtures
is as *EASY* as...

**BYPASS THE BALLAST
+ SCREW IN LED LAMP**

LED EFFICIENCY!



▲
**LED Screw-In
Retrofit
Solutions**

**Reliable Quality...
From the INSIDE Out!**

Over 50 Models – *IN STOCK*



HIGH BAYS



WALL PACKS



CANS



JELLY JARS



LOW BAYS



POST TOPS



www.led-llc.com
847-380-3540

For more information visit tEDmag.com/InfoCard

recording various kinds of warehouse mistakes, key the recorded data into a computerized database or spreadsheet, and generate monthly reports by type of mistake and person. The fulfillment rate is tracked by some ERP systems under the subject of “service level,” but if it is not, the person who reviews the signed copy of packing lists (such as for invoicing) should create a computerized list of orders not delivered on time.

To track fulfillment cost, set up general ledger accounts to record not only direct labor and other direct warehouse costs, but also allocated costs such as electricity costs for the warehouse. The number of orders filled might be stored in the general ledger; if not, other ERP reports would show that number. Use a general-ledger-suitable report generator to calculate total warehouse cost and cost per order.

SOLUTIONS

• **Warehouse mistake rate.** If the rate of warehouse-related mistakes is too high, the monthly report might indicate who is responsible and/or the area where the most mistakes occur (e.g., delivery). If the report provides no clues, start looking for sources of mistakes in the receiving area.

When barcode scanning is not used, a mistake can be made during receiving that goes undetected until a customer calls it to your attention. Walk through the put-away function, pull-down or replenishment functions, interbranch transfers, picking, checking (which is necessary, even with RF picking), and loading. Look for potential mistakes. An example of a condition that can cause mistakes is having two similar products stored next to each other; in the rush of picking, it's easy to pick the wrong box.

New competitors use barcode scanning to avoid mistakes and track the location of orders in process. Electrical distributors not using this technology should investigate its impact on accuracy and warehouse productivity. For distributors in the “bundled services” business (i.e., selling all the products in an entire room and providing related

services such as design, product selection, and acquisition—including buying from other noncompeting distributors—and coordination of delivery and installation), shipping labels with customer and job information encoded in every label are necessary. Each label should also show the piece number and the total number of pieces (e.g., six of 12.)

• **Fulfillment rate.** If the fulfillment rate is less than 100%, the warehouse manager can drill down into the data of any ERP service level report for details on orders that were delivered late and determine the causes. Absent an ERP report, the manager could use a list of orders that were not delivered

on time to research the causes (an example of a situation that can cause lateness is a truck breakdown).

Even when all orders are delivered on time, the fulfillment rate can be less than 100% because a customer is promised a certain quantity but there is not enough product available to fill the order when the order is picked. This mistake occurs when the quantity indicated in the system is greater than the actual physical quantity in the warehouse. An ERP service level report can measure this data. One way to minimize short ships is to cycle-count products, but cycle counts should only be done while there is no product movement activity occurring in the warehouse—and only after the ERP system has been totally updated. (Try cycle-counting early in the morning; some distributors cycle-count from 5 a.m. to 7 a.m.)

• **Fulfillment cost.** When the fulfillment cost is too high, a team of operations and financial personnel should examine the “cost drivers” of direct and allocated costs—e.g., the efficiency of warehouse lighting. For each cost driver that is problematic, consider reducing the level of that driver (but not in such a

way that it hurts customer service or increases other costs, such as changing the number of workers in the warehouse) and investing in something more efficient (provided it would yield an acceptable return on investment, such as a delivery truck). In a bundled services business, the goal is not high productivity; the goal is to quickly find all the products needed for a job.

“E-commerce ‘distributors’ rarely make warehouse mistakes and operate very efficiently, so competing against them requires filling orders accurately, quickly, and at a low cost.”

Fulfillment cost is also affected by the level of warehouse productivity, which suffers when people waste time looking for products that are not stored correctly. Sometimes a product is physically not in the warehouse at all; other times, a product is eventually found in an unassigned location.

To minimize these “can’t finds” and “couldn’t finds,” the ERP system must be able to track the location of each and every piece in the warehouse (including overflow), in the counter area, and in any yard. This means that receiving and delivery staging areas must be assigned location codes, as must areas used for staging customer returns and counter and yard locations. Additionally, workers must record/capture quantity and location data every time a product is moved. ■

Friedman, CMC, has spent the past 30 years helping electrical distributors manage inventory more profitably, prevent costly warehouse mistakes while reducing warehouse costs, and acquire information and warehouse technology. Reach him at 847-256-1410 or at GenBusCon.com. ©2014 General Business Consultants, Inc.

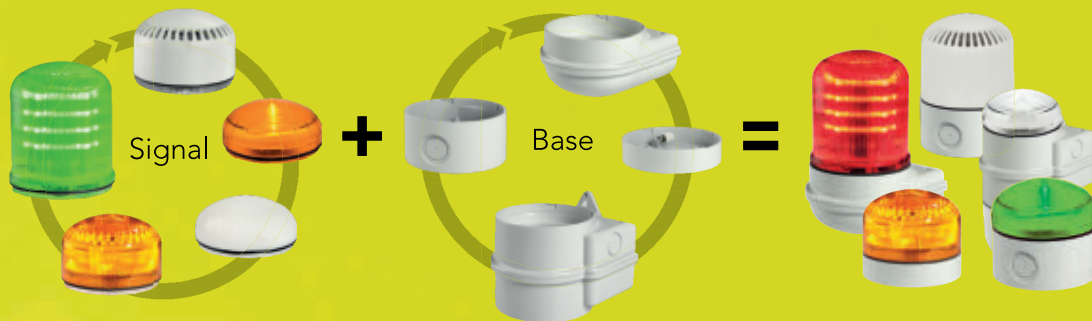

Mix. Match. Mount.

The StreamLine® Modular Series from Federal Signal. Now there's a faster, easier way to customize and reconfigure visual and audible signaling. The StreamLine® Modular Series features a wide range of multifunctional signals and four different bases. All signals and bases use a simple, snap-on technology to easily mix and match together into a multitude of configurations. Which means installation, even in the most challenging environments, is truly a snap.



 **FEDERAL SIGNAL**
Safety and Security Systems
Protecting people and our planet

708.534.4756 www.federal-signal.com



IMAGE COURTESY OF LEDTRONICS

A capital investment

An LED lighting upgrade at a renowned hotel by Shepherd Electric Supply and LEDtronics ensures a brighter and more sustainable stay in the nation's capital. by Susan Bloom

Located just blocks from such high-profile attractions as the White House, the Lincoln Memorial, the complex of Smithsonian museums, Ford's Theater, and the Convention Center in Washington, D.C., the Hilton Garden Inn on 14th Street in the Northwest quadrant of the nation's capital hosts a constant influx of tourists, businesspeople, and dignitaries. And thanks to the recent upgrade of its exterior marquee using LED lighting, the bustling hotel can now rest assured that its hundreds of thousands of annual guests will enjoy a brighter, more inviting, and more sustainable experience than ever before.

The outdoor canopy marquee for the 14-story, 14-year-old hotel, which has 300 rooms and reports a 95% occupancy year-round, represents a critical face to

the public and is an important reflection of the Hilton brand, but according to Santosh Borrison, chief engineer in charge of maintenance, "Several light-

bulbs were always out, and every day one of our maintenance engineers would have to go up on a ladder to change them. It looks bad to have any lights out, especially outside where so many people can see it. We'd been working with Shepherd Electric Supply as our lighting supplier for years, who suggested that we consider LEDs."

A SUSTAINABLE SOLUTION

"Lit by roughly one hundred 12W incandescent bulbs, there were constantly lights out in the hotel's marquee and it was cumbersome for its maintenance people to have to change them all the time, especially on the street right out in front of the hotel," explained Rick Soracoe, sales manager for the more than 120-year-old Shepherd Electric, which serves Baltimore; Washington, D.C.; and surrounding metro areas and prides itself on delivering energy-efficient and sustainable solutions to its customers. "Santosh and his team asked, 'What can we do?' and were very open to converting them to LED if possible."

Knowing that the customer-facing hotel marquee with its prominent outdoor setting and 24/7 operation was a perfect application for the bright, long-lasting, and low-maintenance benefits of LED technology, Soracoe approached LEDtronics, one of its regular suppliers, for a customized solution.

"The old lights on the hotel's canopy marquee were different because they consisted of mini screw-based lamps with polycarbonate globes on each incandescent bulb," noted Gary Anderson, LEDtronics's representative at Eastern Electronics in Raleigh, N.C. "LEDtronics's miniature E10 screw-based T3¼ LED lamps designed for simple LED panel indicators and 12VAC were able to directly replace the incandescent bulbs with warm, white light."

After sampling many different products through Shepherd Electric and LEDtronics throughout the summer of 2012, the lighting manufacturer specially adapted the aforementioned 1W LED bulb and socket to the marquee in

a way that kept the new lighting protected from the elements while matching the look and feel of the previous incandescent source.

"We tested the LEDs for their color by trying eight to 10 of them in the marquee in place of the incandescent bulbs for a week, and they matched very nicely," said Borrison. "From there, we proceeded to do a simple one-for-one changeout of all the bulbs; the installation was easy." The new configuration ultimately brought a vibrancy and 35,000-hour life to the sign while reducing energy consumption and costs by up to 90%, a savings that was very important to the hotel.

REMARKABLE RESULTS

"Two years later, we haven't had to change a single bulb, the color is good, and the whole sign is so much brighter and more inviting," said Borrison. "Rick

and his team at Shepherd Electric helped us by bringing us a variety of product samples in different wattages and colors so that we could test them in the actual application. They went out of their way to get the job done thoroughly." As a result, he added, "Everyone on our management team is happy with the upgrade."

The hotel is currently working with Shepherd Electric to install LEDs in its garage and plans to convert the lighting in guest rooms to LED technology during its next hotel-wide renovation (involving the overhaul of wall-paper, furniture, mattresses, carpet, and

fixtures), which will be launched in the next one to two years. "At that time, we're hoping to be able to take advantage of an LED product rebate from

"Rick and his team at Shepherd Electric helped us by bringing us a variety of product samples in different wattages and colors. They went out of their way to get the job done thoroughly."

—Santosh Borrison, Hilton Garden Inn

Pepco, our local utility, and Shepherd Electric will be helping us with that as well," Borrison said.

"With the new LED bulbs, the Hilton Garden Inn has taken significant steps

orbit
Orbit Industries, Inc.

**YOUR UNIVERSAL SOURCE FOR
ELECTRICAL PRODUCTS**

www.orbitelectric.com

ONE
It's Really This Simple

✓ **Order**
✓ **Shipment**
✓ **Invoice**

**MORE THAN
6000
PRODUCTS
IN STOCK**



98.7% FILL RATE



For more information visit tEDmag.com/InfoCard

to reduce its energy and maintenance costs while increasing sustainability," Anderson said.

"Switching to LED lamps was truly a win-win for us," Borrison explained. "Not only do the lights provide a nice appearance, but also we won't need to change the bulbs for years, which saves us an extensive amount of maintenance time and cost. Facility managers should

definitely consider upgrading to LEDs. They may cost a little extra, but they pay themselves back."

Once marked by unsightly bulb outages in one of the nation's most high-profile locations, "The marquee is completely lit all the time now; the LED technology brightened it up so much and really helps put the hotel's best foot forward. We're grateful to LEDtronics

for the great design that helped make this system work and also applaud the Hilton Garden Inn for being proactive and wanting to make the change," Soracoe concluded. ■

Bloom is a more than 20-year veteran of the lighting and electrical products industry. She can be reached at susan.bloomchester@gmail.com.

LED Update

A closer look at visible light communication

An emerging new technology is putting lighting in an even more direct sales role.

Lighting has long been considered the "silent salesperson" in retail applications, promoting wayfinding and guiding customers to key merchandise. Now a new technology is emerging that will put lighting in an even more direct sales role.

Visible light communication (VLC) is an emerging technology that enables one-way communication between intelligent LED lighting and user smartphones and tablets that feature a special app. The technology uses rapid, instantaneous pulsing (on/off cycles) at frequencies undetectable to the human eye to transmit data and provides two capabilities ideally suited to big box retail applications. The first is wayfinding: The lighting system provides indoor GPS-like functionality that enables the lighting to guide consumers around the store. The second is communication of targeted sales information: As a customer passes products in the aisles, his or her phone would receive coupons, recipes, and other offers.

According to Deloitte Consulting (deloitte.com), in 2012, more than 60% of mobile shoppers used smartphones while in the store, and 85% of consumers were using retailers' native apps or websites during shopping trips. VLC introduces a new way to connect the retailer with its customers to enhance the shopping experience and improve business value through customer engagement and analytics. To follow are three solutions now being demonstrated by major lighting manufacturers:

1. Philips Lighting recently demonstrated its "connected lighting system" at EuroShop and Lightfair. The LED luminaires form a dense network that not only provides lighting but also acts as a positioning grid. Each luminaire is identifiable and able to communicate its position to an app on a shopper's smart device.

"The beauty of the system is that retailers do not have to invest in additional infrastructure to house, power, and support location beacons for indoor positioning," said Gerben van der Lugt, manager. "The light fixtures themselves can com-

municate this information by virtue of their presence everywhere in the store."

2. GE Lighting is collaborating with VLC technology pioneer Byte-Light to demonstrate "LED infrastructure" that will be available in the next generation of GE LED luminaires. GE demonstrated the technology, which uses a combination of VLC and Bluetooth for communication, at Lightfair. The lighting can communicate with smartphones and tablets with a camera.

"GE Lighting's next generation of LEDs will not only save energy and maintenance costs, but also be a strategic enabler to combining big data with location to deliver a more engaging shopping experience that increases customer loyalty and value," said Jaime Irick, general manager of North America Professional Solutions.

3. Acuity Brands developed its own system using its eldoLED driver platform partnered with Lumicast technology from Qualcomm Technologies, a subsidiary of Qualcomm Incorporated. Like Philips and GE, Acuity demonstrated the system at Lightfair and is currently engaging top retailers to conduct proof-of-concept testing. Lumicast determines a mobile user's location within 10 centimeters, as well as the user's orientation within the aisle.

"This new technology allows LED lighting to be an asset for retailers, not only because of the productivity gains, energy savings, and environment improvements it provides, but also because of its emerging capacity for enhancing and changing in-store customer experiences," explained Steve Lydecker, senior vice president. "Guiding the shopper through the store based on the shopper's actual position, VLC technology opens the door for retailers to more effectively engage and influence consumers on the retail floor." ■

Craig DiLouie, LC, principal of Zing Communications (zinginc.com), is a lighting industry journalist, analyst, marketing consultant, and author. Reach him at cdilouie@zinginc.com.

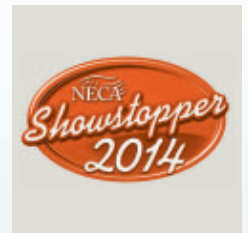
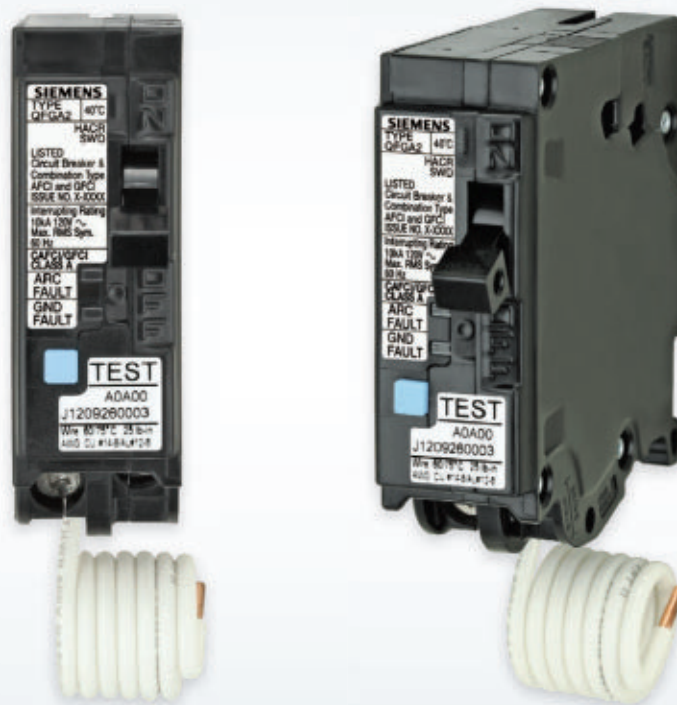

The power of two

Dual Function AFCI / GFCI Circuit Breaker

Siemens has combined GFCI and AFCI into one small device that protects homeowners against both Arc Faults and Ground Faults. NECA 2014 Showstopper Award winning Dual Function AFCI/GFCI Circuit Breakers features:

Features:

- Plug-in or bolt-on options
- Self Test and Lockout feature
(Required by UL 943 effective June 2015)
- Saving time – ease of installation
- LED trip indicator – a Siemens exclusive!
- Available with interrupting rating of 10kA, 22kA or 65kA
- UL Listed CCN: DIYG



CapitalTristate employees Bob Preston (l), energy specialist, and David Wolfe, government business manager, share information during the company's Industrial Tradeshow.

TRADESHOW

CapitalTristate hosts Industrial Tradeshow

CapitalTristate, an Upper Marlboro, Maryland-based unit of Sonepar, hosted the Industrial Tradeshow at Hager Hall in Hagerstown, Md., on Nov. 6.

Dozens of key manufacturers participated, displaying their latest technology and industrial offerings with on-site demonstrations.

In addition, specialists from CapitalTristate were on-site to discuss automation and controls, energy maintenance services, VMI, and kitting and assembly among other services critical to the success of industrial partners.

Nearly 200 CapitalTristate customers and guests attended, enjoying not only the demonstrations, but also food, drinks, and door prizes. Among the door prizes—which were awarded every 15 minutes—were mountain bikes, grills, a Yeti cooler, a Green Egg smoker, and various sports-related items.

GIVING BACK

Halco supports GNTC Earth Craft House project

Halco Lighting Technologies has donated ProLED A19 lamps and ProLED BR30 lamps to the Georgia Northwestern Technical College's (GNTC) Earth Craft House project for use in the energy-efficient model.

As part of the Residential Energy Efficiency Technology program at GNTC, students are building two model/test houses on the Gordon County Campus. The two houses are identical in size, but one is built under the standard/old building specs while the other is built under new green and energy-efficient specifications using new materials and techniques with Earth Craft House and Energy Star ratings.

Hermitage celebrates 300th house lighting donation

Hermitage Lighting Gallery, Nashville, Tenn., was recognized by Habitat for

Humanity of Greater Nashville for its contributions to Habitat in a relationship spanning decades.

In 2004, Jack Fleischer, owner of Hermitage Lighting Gallery, went to the grand opening of Habitat's ReStore in Nashville. From that day on, he supported the ReStore in many ways—from co-hosting lunches and educating other retailers about Habitat's mission to raising more than \$10,000 in support of Habitat's mission by completing an Ironman Triathlon. He has also served on Habitat's board of directors and advisory board.

On Nov. 9, Habitat cut the ribbon at the 300th house for which Hermitage Lighting Gallery has donated the lighting packages.

MaxLite donates to Habitat ReStore, Table to Table

In celebration of the grand opening of its new facility in Anaheim, MaxLite has donated \$14,000 worth of energy-

efficient lighting products to the Habitat for Humanity of Orange County Anaheim ReStore.

"MaxLite is proud to support our local Habitat for Humanity and encourage consumers to embrace quality, energy-efficient lighting," said President



Robyn Willis (l), director of retail operations for the Anaheim ReStore, and Shannon Benson, marketing coordinator for the Anaheim ReStore, accept a donation of energy-efficient lighting products from MaxLite President and CEO Yon Sung.

and CEO Yon Sung. "Our utility solutions team does a tremendous job of working with utilities and their rebate programs to provide lamps and lighting fixtures for sale through Habitat for Humanity ReStores that help save customers energy and maintenance costs."

The company has donated more than

\$300,000 in products to Habitat for Humanity since 2013.

MaxLite has also donated \$1,500 to Table to Table through the organization's "Bag a Lunch, Help a Bunch" program. Table to Table is a community-based food rescue program that collects fresh and perishable food that would

otherwise be wasted and delivers it to nearly 70 recipient agencies that serve the hungry throughout Bergen, Hudson, Passaic, and Essex counties in New Jersey.

This marks the fourth year MaxLite has participated in the campaign. Employee contributions totaled \$750, and

Awards+Honors

ATLANTA LIGHT BULBS NAMED 2014 WINNER OF THE GEORGIA FAMILY BUSINESS AWARDS

Atlanta Light Bulbs has been named as the winner of the Small Business category of the 23rd annual Georgia Family Business of the Year awards by the Cox Family Enterprise Center in the Michael J. Coles College of Business at Kennesaw State University.

The Georgia Family Business of the Year awards honor and recognize the positive contributions provided by family firms that have successfully combined business with family. Companies are chosen on the basis of proven business success, multigenerational family involvement in the business, positive linkages between family and business, contributions to industry and community, and innovative business practices and strategies.



All of the 2014 winners and finalists were honored at the 23rd annual Georgia Family Business of the Year awards dinner on Nov. 6 at The Embassy Suites Atlanta, Kennesaw Town Center. From left: Kelly Leverett, Jesse Root, Mary Root, Jimmy Root, Robert Taitz, and Jessica Mendoza.

IMARK ANNOUNCES 2014 DISTINGUISHED PERFORMANCE AWARDS

On Oct. 20, IMARK Group recognized the following member companies for their effective implementation of IMARK marketing and training programs and their exemplary support of IMARK preferred suppliers during IMARK

Group's 2014 fiscal year (July 1, 2013, through June 30, 2014):

Member(s) of the Year Award

- Blazer Electric Supply, Colorado Springs, Colo.
- Alameda Electrical Distributors, Hayward, Calif.
- Elliott Electric Supply, Nacogdoches, Texas
- Facility Solutions Group, Austin, Texas

Purchasing Power Award

- Sequel Electrical Supply, Meridian, Miss.
- AAI, Auburn, N.Y.
- Crescent Electric Supply, East Dubuque, Ill.
- Harry Cooper Supply, Springfield, Mo.

Excellence in Sales and Marketing Award

- Blazer Electric Supply
- Inline Electric Supply, Huntsville, Ala.
- Granite City Electric Supply, Quincy, Mass.
- Tri-State Supply, Washington, Pa.

GainShare Achievement Award

- Dulles Electric Supply, Sterling, Va.
- Alameda Electrical Distributors
- K&M Electric Supply, Riviera Beach, Fla.
- Colonial Electric Supply, King of Prussia, Pa.
- Elliott Electric Supply
- United Lighting, Hauppauge, N.Y.

KLEIN TOOLS NAMES ROY SMITH 2014 HEAD OF THE CLASS INSTRUCTOR OF THE YEAR

Klein Tools recently gave Roy Smith, a Great Lakes region finalist from Alpena, Mich., its 2014 Head of the Class Award for Instructor of the Year. During his tenure, Smith, a Utility Technology Program head instructor, almost quadrupled the yearly student enrollment as well as designed and developed a pole yard training lab.

"Roy Smith is the epitome of the lineman's lineman," noted Mark Klein, vice president of domestic sales at Klein Tools. "He is a fountain of knowledge, goes by the book, and believes teaching the next generation of linemen is an honor." Smith received \$1,000 in cash, \$1,000 in Klein tools for his school, and a \$50 back-to-school kit for each of his students.

MaxLite matched the contribution dollar for dollar.

WINNERS' CIRCLE

GE awards winners of open innovation challenge

GE's Industrial Solutions business recently announced five winners of its crowd-sourced rotary handle design

competition for its new portfolio of molded case circuit breakers (MCCBs) to be launched in 2015. GE is employing fundamentally different approaches to new product development. As a result, it will introduce this state-of-the-art circuit breaker platform in half the time of its previous product launches. Factors from the five winning ergonomic

designs will be incorporated into this key accessory for GE's MCCBs.

The five winners are Olaf Barski of Barski Design GmbH (Frankfurt, Hessen, Germany), Tom Goddu of Blazing Pencils (Pine Meadow, Conn.), Sandy Richardson of Design Edge (Belrose, New South Wales, Australia), R. Roopnarine of Long Road Enterprises

MILESTONE

FOR FURBAY, PERSISTENCE PAYS OFF IN CANTON

Persistence was Ralph Furbay's watchword when he founded the Furbay Electric Supply Company in Canton, Ohio, in 1934. After all, it took a lot of persistence to get a fledgling company up and running in the throes of the Great Depression. Today, more than 80 years later, Ralph Furbay's grandson, Tim, and the company's 56 employees are reaping the rewards of the elder Furbay's "persistent" efforts.

In truth, the family legacy of the wholesale electrical supply firm took shape many years before the 1934 start date. In fact, it began with Tim Furbay's great-grandfather, Philip Mook, a pioneer in electrical energy and founder of the Mook Electric Supply Company of Canton. A self-taught electrical engineer born to German immigrants, Mook gained experience in a variety of positions in the newly minted electrical industry. In 1906, he purchased Canton's original electrical company and changed its name to his own. In the process, he admonished his employees, "Do your job thoroughly, and do it well." One of his employees took that advice particularly to heart—an energetic and savvy salesman named Ralph Furbay.

Furbay rose to the position of treasurer of Mook Electric and married the boss's daughter, Gourney Valeria Mook. Since Mook's son, Harold, was in line to take over Mook Electric, Furbay made the bold move of starting his own wholesale electrical company. His first order of business was to select a site for his entrepreneurial venture, which turned out to be the old Sell Horse Goods Manufacturing Company near the southwest corner of Schroyer and Tuscarawas streets. (The building is still a part of the Furbay Electric complex today but is scheduled to be torn down in the near future.)

Furbay continued to expand his vision—and his product lines. The initial offerings included GE appliances, toasters, clocks, and even vacuum cleaners. From a modest beginning in the old Sell Harness factory, Furbay enlarged his enterprise to offices and warehouse space across Schroyer and added commercial and residential lighting fixtures, wire and cable, and all types of elec-

trical supplies for contractors. The firm also maintained a facility in Mansfield, Ohio. Tim recently spearheaded a new venture to supply the developing Ohio oil and gas industry with a full line of products to service the Utica Shale fields in eastern Ohio.

Ralph's son, Phil, joined the family venture after serving as Lt. Commander of a PT Boat in the Philippine Islands in WWII. He continued the family tradition of service to the Canton community by serving as president of the Junior Chamber of Commerce, president of the Canton Rotary (of which his grandfather Mook was one of the founders), 4-H leader, and one of the original families of St. Mark's Episcopal Church.

The Furbay family has also participated in NAED for four generations. P.E. Mook and his wife, Anna (Miesmer), were present when the first photograph of Association members was taken for NAED in 1908 (they were the only ones identified in the photo for the 100th anniversary of the organization in 2008). Mook also participated in the 1893 Chicago World's Fair (the first one to use electricity) for Russell and Co. of Massillon. Both Ralph

and Phil were Life Members of NAED and served on its Board of Governors.

Tim joined the family company in 1974 as credit manager after graduating from Heidelberg University and The Ohio State University. As he looks toward the ninth decade of the family business, he noted, "The same advice that my great-grandfather and grandfather followed for their business careers still holds true: Persistence, hard work, a clear vision, excellent customer service, and attention to details continue to be a recipe for success."

Future markets are continuing to evolve, including LED lighting and energy-saving audits, new construction management projects, the oil and gas industry growth, complete wire and cable services, and the need for industrial automation solutions. Tim pointed out, "Without the support of the Canton and Mansfield communities, our loyal customers, and valued employees, the Furbay Electric Supply Company would no longer exist in our community. Thanks to all of them for helping us achieve 80 successful years in business." —tED



Ralph Furbay

(New York), and Giulio Ceppi of Total Tool srl (Milan). Each winner will receive \$10,000.

EVENTS

Meyda Tiffany Lighting sponsors museum exhibit

Meyda Tiffany Lighting is sponsoring "In Company with Angels: Seven Rediscovered Tiffany Windows," an exhibition of stained glass angels created in 1902 in the renowned studios of one of the most illustrious designers of the early 20th century, Louis Comfort Tiffany (1848-1933).

The exhibit opened recently in the Museum of Art at the Munson-Williams Proctor Arts Institute (mwpai.org) in Utica, N.Y., and runs through Jan. 4.

Nora Lighting hosts national training event

Nora Lighting recently hosted a three-day national training conference for

showroom sales representatives from across the country at its Commerce, Calif., headquarters.

More than 40 sales representatives from 21 agencies, representing 39 U.S. territories and Canada, attended the sessions. Attendees were treated to

cocktail receptions, dining events, and a traditional Persian dinner hosted by Nora Executive Vice President Jilla Farzan. ■

 Got an event or news item to share in "tED"? Send it to mbyers@naed.org.



Nora Lighting showroom sales reps attended a national training conference at the company's headquarters. EJ Phillips, national sales manager, showroom division (front, far right), coordinated the event.

ENERGY STAR AWARD 2014 PARTNER OF THE YEAR

Watt's Up?

17W LED Omnidirectional A-Line Lamps

MaxLite's new **100-watt** equivalent delivers soft, bright light in all directions.

- ENERGY STAR®-qualified
- High lumen output and efficacy
- 80 percent energy savings
- Long, 25,000-hour life
- Standard medium base for easy screw-in; GU24 available

maxLED
by **MaxLite**
Simply LED... Simply MaxLED
www.maxlite.com

LIGHTING for tomorrow

For more information visit tEDmag.com/InfoCard



www.atlasled.com

Dear Santa,

Please bring my branch an Atlas LED display full of fixtures that will sell fast at my counter.

Billy - Branch Manager
North Pole Electric Supply

Atlas

Lighting Products



For more information visit tEDmag.com/InfoCard

idw



DATA CERTIFICATION PROGRAM

INTRODUCING IDEA'S **NEW** PROGRAM

designed to measure the **quantity & quality** of data available in the IDW

COMPLIANCE

Completion of
43 Critical Fields
needed to conduct business & sell products



EXCELLENCE

2 Quarterly
Quality Checks
of completed fields to ensure
consistency and accuracy

Compliance



Excellence

= **CERTIFIED**

BETTER DATA. BETTER BUSINESS.

idea 

BY THE INDUSTRY FOR THE INDUSTRY

For more information on IDEA's
Data Certification Program,
please contact IDEA or visit

www.idea4industry.com



Commit to social/digital media in 2015

Frustrated by lack of results with social media? Take advantage of what other companies have already learned and make 2015 your year.

by Katrina Olson

This series of articles started in January 2011 and focused on social media—specifically, pitching social media to management, building a strategy, and managing accounts and information. Subsequent articles discussed the various social media platforms. Over the next three years, the focus was broadened to more strategic topics that incorporated digital media and social media, such as how to use social media for recruiting, trade shows, and crisis management, plus content marketing and podcasting. All of those months and all of that advice...and many distributor marketing personnel, stymied by less-than-stellar efforts, are throwing their hands up in frustration. But this is not the time to give up. For better or worse, social media is here to stay, making now the time to regroup, refocus, and recommit to a social/digital media plan that will drive success in the new year.

Let's start by looking at the difference between digital media and social media. Social media refers to interactions among people that are facilitated by websites or applications. Users create, share, and exchange content and participate in social networking platforms like Facebook or Twitter. These applications make it easy for businesses to engage in social media marketing—using social media to market goods and services.

Digital media is the broader category of which social media is a subcategory. Digital media involves using computers, software, and networks to create, store, or distribute information using binary code, often with some level of interactivity. For example, Netflix uses digital media to deliver streaming video and enables users to choose, rate, and list content for future viewing.

Digital marketing delivers content, often to highly targeted audiences. For example, emailing a digital newsletter or promotional message to customers is digital marketing.

The easiest way for companies to “go digital” is to first experiment with social media. And with the proliferation of smartphones, it makes even more sense. A 2013 study by global research firm IDC (idc.com) found that the average number of daily sessions on Facebook was 14 for mobile users between the ages of 18 and 44. Further, checking Facebook was the second most popular activity for mobile users, next to checking email.

Today, many companies are still digital beginners. Others are ahead of the

curve and on their way to becoming digital businesses—managing inventory and other processes digitally in real time, taking orders on mobile sites, and developing apps to make it easier for customers to do business with them.

Incorporating social media is the first step toward becoming a digital business. So why are some companies reluctant to take that first step?

UNDERESTIMATING THE IMPACT ON THE BOTTOM LINE

According to an April 2013 article on Social Business News (socialbusinessnews.com), one reason companies don't embrace digital media is that executives don't understand the potential positive impact on their bottom lines.

A study titled *The Digital Advantage* by global technology consulting firm Capgemini (capgemini.com) revealed that companies with a strong digital culture outperform their peers in every industry. The results of the two-year study, conducted in partnership with the MIT Sloan School of Management in Cambridge, Mass., looked at the financial performance of the companies studied and linked this back to their level of involvement in digital media.

Companies that use technology to change the way they operate and whose leaders not only support, but also drive digital transformation within the company are 26% more profitable than their competitors, generate 9% more revenue through employees and physical assets, and generate 12% higher market valuation ratios.

INDUSTRY NEWS



► Anixter awarded

Anixter International has received *Control Design* magazine's “2014 Readers' Choice Award.” Anixter was selected as a leader in Service and Support for Wire and Cable by the readership, highlighting the company's core service value to the manufacturing industry.

► Hubbell Lighting joins

Hubbell Lighting has announced today that Hubbell Building Automation is now a member of the Connected Lighting Alliance.

► Siemens named in DJSI

Siemens has been named the most sustainable company in its industry group in this year's Dow Jones Sustainability Index (DJSI). Siemens ranked first in the Capital Goods Industry Group, which includes about 350 companies from seven sectors. Siemens has been represented every year since the DJSI was first published 15 years ago.

► Solectria is a “Top” biz

Solectria Renewables has been included in *The Boston Globe Magazine* and the Commonwealth Institute's annual “Top 100 Women-Led Businesses in Massachusetts.” Honored companies were selected based on revenue or operating budget, workplace and management diversity, innovation, and number of full-time employees.

► The DOE launches app

The DOE recently launched its “Lantern Live” mobile app, which helps users quickly find and share critical information about nearby gas stations and power outages during energy emergencies.

For up-to-date industry news and information, go to tEDmag.com.

MORE FIREPOWER IN THE TOOLBOX

THE TG165 SHOWS WHAT'S HOT
FOR INSTANT TROUBLESHOOTING.

The FLIR TG165 imaging IR
thermometer bridges the gap
between single spot infrared
thermometers and FLIR's legendary
thermal cameras.

Check out the interactive simulator
to experience this groundbreaking
tool in action.



Speed & Accuracy

VISUALLY KNOW WHERE TO TARGET

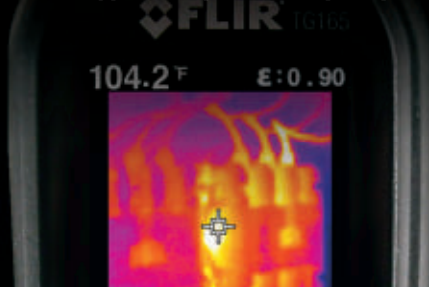

Stay Safe

24:1 SPOT SIZE RATIO



Rugged & Reliable

DESIGNED TO WITHSTAND THE
HARSHTEST ENVIRONMENTS



SEE THE HEAT AT FLIR.COM/TG165/ELECTRICAL

FLIR

The World's Sixth Sense™

For more information visit tEDmag.com/InfoCard

Executives who don't understand the potential impact on their business are not providing the validation, direction, and resources necessary to move toward becoming a digital/social business. It is those companies that are going to be left behind.

OVERCOMING OBJECTIONS TO USING SOCIAL MEDIA

Businesspeople avoid social media for a variety of reasons; here are just a few:

Reason No. 1. "Social media is just a fad." Social media is not a fad; it's how we now communicate and connect with one another—in business and in

our personal lives. Consider the following statistics:

- Twitter has 271 million monthly active users.
- Five hundred million tweets are sent each day.
- Seventy-eight percent of Twitter-active Internet users are on mobile devices.
- Five hundred million tweets are sent each day.
- Facebook currently has 1.23 billion monthly active users.
- Facebook currently has 1.07 billion mobile active users.
- Eight hundred and twenty-nine

million people log on to Facebook every day.

- LinkedIn currently has more than 313 million registered members.
- Two new people join LinkedIn every second.
- YouTube has more than 1 billion unique users each month.
- More than 6 billion hours of video are watched every month.

Don't assume all these users are college kids or teenagers. According to the Pew Internet Project (pewinternet.org; as of January 2014), 82% of Internet users between the ages of 30 and 49 use social media. Of Internet users ages

FRENCH GERLEMAN GROWS WITH SOCIAL MEDIA

Founded in 1923 in St. Louis, French Gerleman has grown from a small motor repair shop to a regional distributor with five regional branch locations and a \$20 million inventory.

Throughout its history, the company has focused on its customers' success and profitability, making the leap into social media a natural progression for the firm. "By 2011, we knew we needed to join the social media conversation and saw Facebook, Twitter, and LinkedIn as new tools for communicating with customers, suppliers, and other industry participants, especially the younger industry members who have embraced social media," said Kim Mathes, marketing communications manager.

The reasons for joining all three of the major social media sites at the same time were their popularity and relevance to the audience. "As part of the decision-making process, we conducted surveys of our customers and employees to gauge which sites they were using. Additionally, through our research, we learned that Facebook has more a personal tone, LinkedIn is designed for the business side of communication, and Twitter tends to be fast paced and more fluid," Mathes observed.

Since each platform is different, French Gerleman strives to ensure that its messages will be relevant and timely and will fit the style of each site. "We aim to post to Twitter at least twice a day, to Facebook three to five times a week, and to LinkedIn at least once a week," Mathes said. These numbers, of course, can vary, depending on the feedback and questions received from followers in response. The posts themselves cover material such as events; promotions; open houses; counter and customer appreciation days; career opportunity and new employee announcements; and product news, information, and technical help. "Most news and informational posts make it onto our Facebook and Twitter accounts, but we reserve LinkedIn for more formal communications," Mathes added.

While focusing on the basics of social media posts, French Gerleman is simultaneously engaging customers, prospects, employees, and manufacturers in active conversation. In one special area, the company is using social media to engage directly with manufacturers' marketing teams on a daily or weekly basis to further cement the relationships and advance the manufacturers' messages to employees and customers. As part of this effort, the company will tag suppliers in its posts. "We have not seen this being done often in other industry social media posts," Mathes said.

In addition, the company cross-references its website and social media sites so that posts on social media sites will link the follower back to the website for more detailed information. "By their nature, social media sites limit the amount of content that can be included in a post, making links to the website for more detailed information critical," noted Mathes.

Overall, employees, manufacturers, and customers have been posting positive feedback. Other metrics, such as retweets and likes, are also demonstrating followers' increasing engagement with the sites. "Likes, follows, and other forms of positive engagement have maintained continuous growth since our social media sites launched," she added.

In addition to the "Big 3," French Gerleman has accounts on Google+ and Instagram but is not currently active on them. "We wanted to have them ready and at our disposal for the time when we do want to broaden our social media activities," Mathes explained. Until then, the company plans to continue to keep its social media presence moving forward and to focus on engaging customers, employees, and suppliers in more two-way conversations. ■

Darlene Bremer is a freelance writer based in Solomons, Md., and a frequent contributor to "tED" magazine. She can be reached at darbremer@comcast.net.

50 to 64, 65% use social media. Factors like gender, education level, and income have little influence over who uses social media.

Reason No. 2. “No one on staff knows how to effectively use social media.” Chances are, employees are using social media in their personal lives. With a little education and training, they can apply those skills in a way that benefits their employer. Start by talking with the employees in marketing, public relations, and information technology or with the web team about spearheading the company’s social marketing effort. If they’re not interested, create a new position and hire someone who is already qualified.

Reason No. 3. “We can’t control what people say on social media.” While this is true, it’s not necessarily a negative. If a company is performing or attempting to perform at its highest level, the feedback will help it improve. Further, hearing issues or complaints directly from customers gives the company the opportunity to respond immediately, address the issue, and prevent an even larger problem.

Social media’s greatest benefit is interactivity. Yes, it takes time to respond and resolve problems or issues, but most customers who have a bad experience will simply leave without explaining why. Social media makes it easier for customers to complain, which also makes it easier for the company to correct the problem and mend the relationship.

Reason No. 4. “It’s impossible to measure the impact of social media.” Methods and tools for measuring social media’s impact are getting better every day. Research online or hire a firm that specializes in social media to help navigate the many measurement options available.

Reason No. 5. “We are so far behind now that we’ll never catch up.” It’s never too late to start. The good news is, social media’s early adopters have already addressed many of the issues and solved many of the first-time user problems and challenges. There are

thousands of case studies, articles, and best practices for using social media—making it much easier for latecomers to catch up.

Reason No. 6. “We don’t even know where to start.” According to independent research company eMarketer (emarketer.com) in its *Social Media Advertising: Seven Trends for 2014* report, 87% of U.S. companies used social media for marketing in 2013. That number was 85% in 2012, and it’s expected to rise to 88% for 2014. Business use of social media is not decreasing.

Start with Facebook or Twitter. According to an infographic by online marketing firm VerticalResponse (verticalresponse.com), 90% of small businesses use social media, with Facebook and Twitter as the two most widely used platforms.

Reason No. 7. “We can’t afford the time to use social media.” Both Facebook and Twitter are very easy to set up, use, and manage. According to a VerticalResponse infographic, 63% of CEOs, owners, and proprietors spend just one to five hours a week on social media.

Develop a basic plan for maintaining your Facebook presence. Maybe it’s a Facebook post every Tuesday and Thursday to share a piece of useful information, or maybe it’s tweets on Monday and Friday to announce a weekly special or event. Set up a schedule and be consistent.

Reason No. 8. “We wouldn’t know what to say.” Look at how similar companies or competitors are using the medium. Think about what content your readers and customers want. They may want to know about new products or services, how to use existing ones, or anything that can help make their jobs easier.

And remember, not all content must be original: Many companies repost or retweet information from other sources or repurpose content from other company communications.

Social media is not going away. Instead, it’s getting more pervasive and even necessary for business success.



Benefits of using social/digital media

Need a few more reasons to use social media for business? Effective use of social media can provide:

- More awareness of the organization, products, or services
- Increased traffic to the company website or other social media sites
- More favorable perceptions of the organization, products, or services
- The ability to monitor what’s being said about the organization
- The ability to develop highly targeted marketing activities
- A better understanding of customers’ wants, needs, and perceptions of the company
- Potential for an increase in new business and more business from existing customers
- A means of identifying new product, service, or business opportunities
- Early warning of potential product, service, or company issues that could become crises —K.O.

And we’re getting better at evaluating and tracking the results. Take advantage of what other companies have already learned and make 2015 the year your company establishes or grows its social media presence. ■

Olson is a University of Illinois advertising and public relations professor, strategic communications consultant, and regular “tED” contributor. She can be reached at katrina@katrinaolson.com.

Reach New Heights

with NAED's
**Branch
Management
University**

Enroll Now.
*Online classes forming
for the January 1, 2015
semester.*

www.naed.org/enroll

business



© ISTOCK/THINKSTOCK

Protect your most valuable asset

No branch can survive, let alone thrive, without loyal customers. Here are five ways to help hang on to each and every one. **by William Lynott**

Business is tough in our competitive economy—and getting tougher. In times like these, every customer becomes a critically important asset that a distributor can't afford to lose. Over the years, marketing studies have consistently shown that the cost of finding a new customer is about five times the cost of retaining an old one, which means that keeping old customers coming back should be a permanent part of every branch manager's marketing program.

Put simply, satisfied customers are the foundation for the continued health of a distributorship. If that foundation is allowed to erode, the business is headed for tough times. With that in mind, here are five powerful ways to help hang on to existing customers and generate the kind of referrals that will help to build business further:

1. Make customer satisfaction a hallmark of business. Customer satisfaction is the least expensive, most powerful marketing medium available to

a distributorship. Nothing will build loyalty faster than when a company's satisfied customers brag to their associates about their relationship with that company—and nothing will eat away at that company's business more relentlessly than unhappy customers complaining about it.

"Some businesspeople tend to lose an opportunity when dealing with a difficult customer," said Christopher Simmons, CEO of the business marketing firm Neotrope (neotrope.com). "By

focusing on making every customer happy, the seeds for a long-term relationship are planted. Flexibility in customer relations is essential in building long-term customer loyalty.”

To be sure, it sometimes takes both time and money to resolve a customer complaint, and it can be especially trying when the complaint is not justified. The point to remember is that the dollars spent resolving any complaint are marketing dollars—arguably the most effective customer-loyalty dollars that can be spent.

2. Determine to never lose a customer to a competitor. On average, it costs five times as much for a business to find a new customer than to keep an old one. Focus on the significance of that statement; it is one of the most powerful concepts in the world of business management.

The competition is ready to snatch customers away. Armed with that knowledge—and the awareness of the cost of replacing a lost customer—it should be easy to understand the importance of never giving a customer a reason to stray.

Once a new customer places its first order, the hard part is over. Now, it's time to instill the notion that doing business with the company will always be a satisfying and rewarding experience.

The company and its employees must never lose sight of the fact that developing a new customer is a costly and difficult job. Once this stranger “crosses your threshold,” a major part of the overall marketing program must be centered on ways to make sure that he or she never has reason to leave for a competitor.

What problems are most likely to cause customers to default to a competitor? Experts offer these five potential pitfalls:

- Not knowing the customers and their needs
- Treating customers like numbers and lacking a personal touch
- Having inadequate customer service and sales support
- Lacking the customer communi-

cations to keep customers engaged

- Not addressing customer issues/concerns in a timely fashion

3. Set the business apart. America's most successful entrepreneurs are those who have carefully developed a unique identity. A company's job is to evaluate its strengths and combine them to form a unique, identifiable image.

Perhaps the company has been in business longer than its nearest competitors. Or

maybe the employees have the kind of skills, product knowledge, and desire to satisfy that will allow a customer to feel that dealing with the company will always be a satisfying and rewarding

experience. Or perhaps there is a long and impressive list of satisfied customers. Whatever the company's marketable strengths, write them all down, study them, and then determine how they can be used to separate the company from its competitors. Find ways to motivate potential customers to seek you out and make existing customers feel fortunate to have access to the company's services.

4. Never break a promise. There is no easier way to alienate a customer permanently than breaking a promise. “Keeping promises is a vital part of solid customer relations,” said Simmons. “For example, when a company agrees to order something special for a customer, a promise has been made. Now, the company must do everything it possibly can to make certain that promise is not broken.”

A company that finds itself in a position of having to break a promise should contact the customer as soon as the problem is discovered. An early explanation and a sincere apology will go a long way toward easing the customer's frustration.

5. Go the extra mile. Some years ago, a major retail marketing study revealed that customers whose complaints were satisfactorily resolved became better customers of the company than they were before the incident that triggered the complaint. In fact, some of the most successful companies in the world have been built on a foundation that revolves around the principle that customer complaints provide

“By focusing on making every customer happy, the seeds for a long-term relationship are planted. Flexibility in customer relations is essential in building long-term customer loyalty.”

—Christopher Simmons, Neotrope

a valuable opportunity to build the business.

When L.L. Bean, founder of one of the world's most successful catalog order firms, was starting out, he suffered what could have been a disastrous setback. Shortly after he began shipping his first waterproof, hand-made boots, complaints that the boots leaked started coming in from customers.

Determined to fulfill his promise of complete satisfaction, Bean returned the full purchase price to every customer and then set out to correct the flaw in the boot's design. That was the beginning of the customer loyalty that helped to make L.L. Bean what it is today.

Sometimes satisfying a complaint—especially from a difficult customer—calls for measures that you may feel are unreasonable. When that happens, think of the cost in time and money as an investment in the future of your business. ■

Lynott is a veteran freelance writer who specializes in business management and personal and business finance. Reach him at lynott@verizon.net or blynott.com.

Understanding lien waivers

A lot of confusion surrounds the lien waiver document in the construction industry — confusion that often leads companies to disregarding them and their potential effects. **by Scott Wolfe Jr.**

Lien waivers are exchanged thousands of times daily and can carry significant legal consequences. Despite this, they are infrequently reviewed by legal counsel and exchanged with the nonchalance of a grocery store receipt. Interestingly, the lien waiver document is supposed to be just that: a paper receipt exchanged between the parties to evidence an exchange in funds. The process, however, has been corrupted by parties who leverage their position as the payor to gain an unfair advantage over those who need to get paid—and get paid fast. This modified and degraded process leaves electrical contractors and distributors in a precarious position with clearly defined pain points.

The first problem is that the time a lien waiver is requested usually coincides with a payment being due. The contractor or distributor, in other words, has furnished the project, billed, and waited for payment and is now ready to reach out its hands and get the cash. Signing the inconspicuous lien waiver document seems like a small price to pay to facilitate actually receiving the money, right?

The paying party is aware of that

position, however, and many use the opportunity to button up their own liability and exposure on the project as a whole. A lot of lien waiver clauses swing for the fences, asking the signing party to waive lien rights out of proportion to the payment and also to waive their rights to any claims or disputes of any kind.

Companies are well advised to give lien waiver documents close scrutiny and to negotiate compromising terms,

which leads us to the second problem: There is no time to negotiate the compromising terms mentioned earlier, and even if there was, it's extraordinarily impractical to give the lien waiver documents the close scrutiny they require.

It's difficult to require or expect company accountants, credit managers, controllers, and other administrators to put on their lawyer hat and review these intricate documents and legal terms. It's also impractical to hire an attorney to do it. Even the larger companies with in-house legal departments find it hard to justify a legal review of all lien waivers.

Match the causes and effects in the chart below, and then we'll look at how you did and dig into just how complicated the lien waiver landscape can be, underscoring the challenges facing electrical contractors and distributors.

Clauses	Effects
<p>Clause A: <i>California's Final Lien Waiver Form:</i> This document waives and releases lien, stop payment notice, and payment bond rights that claimant has for labor and service provided.... The document is effective only on the claimant's receipt of payment from the financial institution.</p>	<p>Effect A: The lien waiver is potentially invalid to waive all rights, claims, or causes of action because depending on the particular facts of the case, the lien waiver document may be just a "receipt of payment acknowledgement" insufficient to result in a waiver of claims.</p>
<p>Clause B: <i>Douglas Company Partial Waiver and Lien Release:</i> In consideration of the payments made...the undersigned...hereby waive, release, and relinquish any and all rights, claims, demands, liens, claims for relief, causes of action, and the like...arising out of the...work...through the effective date of this waiver and release.</p>	<p>Effect B: The lien waiver will eliminate and cancel all claims whatsoever that existed as of the date the document is signed.</p>
<p>Clause C: <i>Hunt Construction Group Waiver Processed Through Textura:</i> The undersigned waives, releases, and relinquishes any and all claims, rights, or causes of action whatsoever arising out of or in the course of work...[and] no other monies are claimed to be due...except as listed on the reverse side hereof.</p>	<p>Effect C: The lien waiver will release lien rights when payment is actually received by the potential claimant.</p>

Match the different contingent payment clauses to their possible effect in the chart above. See answers on page 50.

SNAP²IT[®] CONNECTOR

NO TOOLS...SAVES TIME • SECURE HOLD • EASY CABLE INSERTION

EASY TO INSTALL...

1
BEND
CABLE
IN
SLIGHT
ARC

2
INSERT
CABLE
INTO
FITTING

3
SNAP
ASSEMBLY
INTO BOX



AT THE SAME COST PER CONNECTOR!

- Easy snap-in cable installation... SAVES A MINUTE each over 2-screw styles
- Handles widest range & variety of cables: 14/2 to 10/2...AC, MC, HCF, MC continuous corrugated aluminum cable, MCI-A cables (steel and aluminum), AC90 and ACG90
- Fast, super-secure installation
No pullout!
- Easy to remove from cable or box... reusable!



CABLE TYPE	38900ST		40900ST	
	Dia. Range	Cable Range	Dia. Range	Cable Range
MC/HCF/AC Steel & Aluminum	.405 to .605	14/2, and 12/2 with & w/o ground.	.485 to .610	14/3, 12/2, and 12/3 with & w/o ground.
MCI-A Steel & Aluminum	.440 to .550	14/3, 14/4	.480 to .580	14/4 with & w/o ground.
AC90, ACG90	.450 to .550	12/3, 12/4, 10/2, 10/3	.480 to .550	12/4, 10/2, 10/3
Flexible Metal Conduit Steel & Aluminum (RWFMC)	3/8" Flex*			

*CSA Listed w anti-short bushing ONLY



Patent pending

www.aifittings.com Scranton, PA 18517 800/233-4717

For more information visit tEDmag.com/InfoCard

HOW DID YOU DO?

Answers to chart on page 48: Clause A has Effect C. Clause B has Effect B. Clause C has Effect A. Additionally, both Clauses B and C could be declared null and void on their faces if used in one of the 12 states with statutorily mandated lien waiver forms.

Note: For this column, I searched online and found hundreds of different versions of lien waivers, both independently created and statutorily mandated (12 states have statutory waiver forms); from these, three representative waivers were selected for examination:

(1) The *California Conditional Waiver and Release upon Final Payment* form is established and mandated by California state law. It is available for free download at zlien.com/forms/California-Lien-Waiver-Final-Conditional.pdf.

(2) The *Douglas Company Partial Waiver and Lien Release* is the document the Douglas Company may require its

subcontractors and suppliers to sign to receive payment: douglascompany.com/TheDouglasCompany/media/Douglas-Company/Documents/2-Partial-Lower-Tier-Your-Vendors-Waiver.pdf.

(3) Language in the *Hunt Construction Group Waiver Processed through Textura* waiver form required its subcontractors to submit through the Textura Construction Payment Management system, according to the recent Supreme Court of New York case, *The Laquila Group, Inc. v. Hunt Construction* (2014). It is available at constructlawph.files.wordpress.com/2014/08/2014_n_y_misc_lexis_2824.pdf.

• Clause A: "Twelve states make things easy."

Clause A is the simplest of the three because its language is taken straight from the California lien statutes.

Those doing business in California may have recognized the language immediately because California is one of

12 states that have mandatory lien waiver language within their laws. In other words, every lien waiver in these states must look exactly as required by the statute. Contractors and owners who try to slip in additional waivers or use the waiver for other legal positioning are just wasting their time because such attempts are typically invalidated as a matter of rule.

This makes life a lot easier for contractors and suppliers. But more importantly, it makes life more fair.

The 12 states in which lien waivers are statutorily regulated (shown in the chart below) have all taken measures to restrict owners, lenders, and general contractors from using the lien waiver moment to take advantage of subcontractors and suppliers.

• Clause B: "The back breaker."

Clause B comes from the Douglas Company form *Partial Waiver and Lien Release*. Is that company, however, tak-

ing advantage of its leverage and position by asking subcontractors and suppliers to not only waive their lien rights in exchange for a payment, but also "waive, release, and relinquish any and all rights, claims, demands, liens, claims for relief, causes of action, and the like, whether arising at law, under a contract, in tort, in equity, or otherwise...?"

The lien waiver process was not designed to be an all-encompassing waiver of any

States in which lien waivers are statutorily regulated

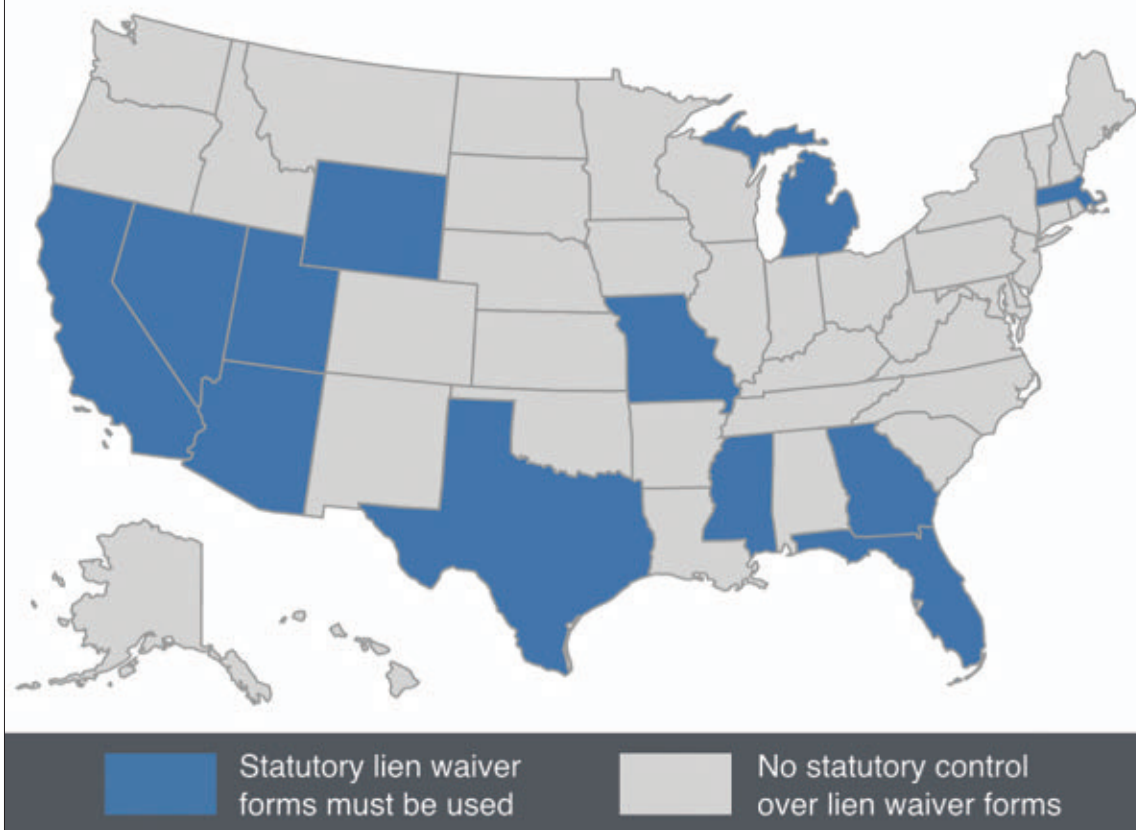

and all contract, tort, and equity rights. Nevertheless, despite the fact that a company's field reps may not be in direct communication with the accounting and legal departments, the person who ultimately puts ink on this lien waiver is going to compromise the company's rights all across the project under every circumstance.

This type of lien waiver can be referred to as the "back breaker." It figuratively breaks the back of the contractor or supplier. Payment is held up if the agreement is not signed, and by signing the agreement, the subcontractor or supplier must just hope that everything has gone perfectly with the project and will continue to go perfectly—because the company may have no means to recover if it doesn't.

If this waiver showed up in one of the 12 regulated waiver states, it would be tossed out as invalid and against public policy. But what would happen in the other 38 states if this waiver was challenged? It's hard to say, but Clause C may paint the picture for one possible scenario.

• **Clause C: The "pigs get fatter and hogs go to slaughter" waiver.**

This Clause C waiver has been given this description because the waiver was ultimately sidestepped by a court in New York. And even though New York is an unregulated waiver state—meaning that waiver language can say anything agreed to by the parties—the New York court had this to say about the waiver's overreaching language in *The Laquila Group Inc. v. Hunt Construction*: "A general release will not be read as applying to claims the parties did not intent to waive, and the scope of a release will thus be interpreted with consideration of its purpose and context."

The Clause C waiver in this *Laquila Group* case was actually requested and processed through the Textura Construction Payment Management system, which may have created part of the problem for Hunt.

The Textura system makes the lien waiver process "electronic," but there seems to be some question as to whether that means the system is merely enabling companies to sign a document electronically instead of with ink or if the electronization (so to speak) of the process is making the lien waiver exchange even more informal and automatic than it was before.

That brings the court to wonder whether it is valid, fair, unjust, and/or against public policy to allow general contractors and owners to use the payment exchange moment to gain leverage over the signer for any and all unrelated claims. Regarding this issue, the *Laquila Group* court said that "the circumstances surrounding the execution of these documents reveal an issue of fact regarding whether the documents constituted mere receipts for payment actually received."

Another problem with this waiver was that the Textura system did not allow the signer to add disputed contract items to the "back of the page" as called for in the form, since the electronic transmittal did not have a "back of the page."

THE UNFORTUNATE REALITY

Lien waivers are exchanged thousands of times each day across the country and—usually—everything goes fine, and that reality can moderate a company's caution and apprehension about these documents. Accompanying the practical reality that the lien waiver process generally works is the practical pressures on contractors and distributors to make the process as smooth as possible to ensure their industry relationships are strong and their cash flow consistent.

Nevertheless, the risk presented by these documents cannot be understated. While things are usually okay, such is the case with any risk issue. Risk is definitely about problems that arise from situations when problems usually don't arise.

There are more questions than answers for subcontractors and suppliers that face these lien waiver challenges. However, these parties should be demanding more fair treatment and legislative movement on the issue. Abuse of the lien waiver process is wrong, and it's the contractors and suppliers that are put in harm's way. ■

Wolfe, a licensed attorney in six states, is the CEO of zlien (zlien.com) and founding author of "The Lien and Credit Journal." Reach him at twitter.com/scottwolfejr and plus.google.com/+ScottWolfejr.



Over 250,000 students
and 90,000 adults want you
to discover their passion, too.

FIRST®: a not-for-profit group, designs fun robotics competition programs to help kids develop a passion for (or a career in) science, engineering, technology, and math. Care to help us?



FOR INSPIRATION AND RECOGNITION OF SCIENCE AND TECHNOLOGY **FIRST**

To learn how to get involved in your area, please visit us today.

WWW.USFIRST.ORG

For more information visit tEDmag.com/InfoCard



The future of data

Is IDEA's vision of "publish once, serve many" within reach? **by Misty Byers**

© CURV/ABEYER/ISTOCK

2. Distributors may not have pushed manufacturer partners hard enough to provide complete data to a single source, but have instead accepted incomplete data and data directly from manufacturers and third parties or filled in gaps on their own.

Thus, in an effort to make the IDW the single source of high-quality data it was designed to be, IDEA had to devote time and resources to collect data from multiple locations for each manufacturer, making it difficult for the IDW to move forward quickly. As a result of these obstacles, our industry has lagged behind other channels in gaining supply chain efficiency and driving the demand that the digital economy can enable.

Our industry has changed significantly since IDEA began. Today, as more distributors seek to build strong web storefronts and further enhance their e-commerce capabilities, the channel has come together with a renewed determination to access consistent, high-quality data from one location.

By making it simple for our customers to work in a one-to-many environment, IDEA can avoid competing with manufacturers that bypass the IDW in favor of delivering information directly to their trading partners and third-party providers, adding further internal operations cost for themselves and their trading partners.

In fact, through the IDW, we are close to realizing the potential we all hope for. Manufacturers can reach more than 4,000 distributor branches and will soon have access to more than \$80 billion in contractor business, all while publishing their product and pricing data just one time. In turn, distributors can easily access the data of more than 2,000 brands, depending on their access authorization.

To build on this momentum, IDEA has introduced new tools and initiatives, including:

- Strengthening the data standards

To say that IDEA and, more specifically, the IDW experienced growing pains over the years is a fair assessment. In an effort to help readers better understand the IDW and where it is heading, *tED* will use this space each month to answer questions and provide information about IDEA's plans going forward. Is there something you want to know about IDEA and the IDW? Submit your question to *tED* Editor Misty Byers (mbyers@naed.org) and it will be addressed in a future issue. To get things started, we asked IDEA CEO Chris Curtis: What has been IDEA's biggest hurdle to date, and what is being done to resolve it today that is different from past attempts? Here is his response:

Since 1998, IDEA has worked toward becoming a single source of complete, high-quality data, delivered efficiently and cost-effectively. The first major step began with electronic data interchange (EDI), with which IDEA was able to drive efficient transactions between trading partners with a widely adopted industry standard. The second major initiative is the one on which we are currently focused: the Industry Data Warehouse (IDW). The IDW was designed to allow manufacturers to securely share

product and pricing data with numerous trading partners from one centralized location and in one standardized electronic format. In essence: publish once, serve many.

While working to advance the IDW, IDEA has consistently faced two major challenges:

1. Consolidated and well-governed data has not been the norm for industrial companies. Therefore, properly gathering the data has been a slower, more manual process than anticipated.

NEXT MONTH WE ASK IDEA: "WHAT PERCENT OF ALL ELECTRICAL DISTRIBUTORS ARE ACTUALLY USING THE IDW...AND WHAT IS BEING DONE TO ADDRESS THE CONCERNS OF THOSE HESITANT TO USE IT?" GOT A QUESTION FOR IDEA? SEND IT TO [MBYERS@NAED.ORG](mailto:mbyers@naed.org).

process, including harmonization of the Electrical Attribute Schema and the ETIM standard

- Launching the new Data Certification Program to not only help manufacturers structure their data in compliance with the Schema expectations, but also provide distribution with the assurance that the information used to market its

products is of good quality and is readily usable

Combined, these factors have led to an increased commitment by manufacturers to deliver the critical data needed by distributors, which, in turn, can help streamline business, lower internal costs, and increase sales.

Communication between trading

partners has never been better. Today's mission is within our reach, and overcoming the hurdles of the past has sharpened our vision and ability to achieve the one-to-many solution IDEA was created to provide. ■

Byers is editor of *tED* magazine. Reach her at mbyers@naed.org or 314-812-5316.

On the Bookshelf

The Greatest Words You've Never Heard

We can all use an occasional dose of inspiration and motivation. Steven Kayser, an award-winning media personality and author, recently released a new book that will do just that. A collection of true stories of triumph, *The Greatest Words You've Never Heard* will not only inspire your soul, but also engage your heart. As Kayser writes, "...words can make you laugh or make you cry, engage or enrage, bring joy or sorrow. Words herald new life or memorialize lives gone by. The right words can inspire great acts of heroism, the wrong ones despicable acts of evil."

Kayser's book is filled with stories that resonate with hope and resilience. Some of the stories may be familiar to the reader, while others will be completely new. The book explores the depths of human connection through the words and experiences of people you've probably never heard of before. The stories are thought provoking and insightful and filled with passion. They are not only gripping stories of triumph, but also true tales of heroism.

One of the chapters, titled "An Inconvenient Genius—The Timeless Legacy of an Untimely Man," is particularly relevant to the electrical industry. The chapter describes the heroism of renowned scientist Nikola Tesla, whose notable inventions helped shape the electrical world as we know it today. As it turns out, many of his inventions and ideas were credited to others. Tesla's invention of AC electrical transmission, for example, paved the way for many other inventors, including Thomas Edison and Charles Steinmetz. Tesla wanted to give mankind the gift of free, wireless electricity. However, his innate sense of altruism and his great indifference to greed and egotism were ultimately his undoing. As Kayser writes, "Tesla, the iconic genius, was left out of the history books. He should have been a billionaire, but died essentially penniless at the age of 87." However, if you read one of Tesla's quotes—words you've probably never heard—you'll learn that he considered his life's work a success, for his mission as a scientist was to lay the foundation for others to build upon.

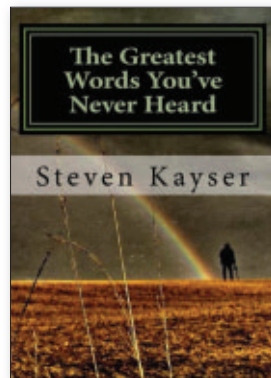

Although Kayser's work isn't considered a classic business book, his chapter on "How to Stay Relevant in Business and Life" offers sage advice for everyone in the business world. "The most valuable employee in any company, regardless of education, intelligence, or tenure, is the autodidact...an individual who has the skill and ambition to figure things out on [his or her] own," writes Kayser. Autodidacts don't have to be taught how to do a job and are powerfully motivated and disciplined. Kayser emphasizes the importance of staying in a "constant learning mode." He dives deeply into how to remain

"RELEVANT" on the job, using an acronym to help convey his message. In the business world, you need to take Risks, Experiment, Listen, Engage, create Value, keep a positive Attitude, and avoid Negativity—all while being aware that Time is your most valuable asset. Kayser credits his "How to Stay Relevant" manifesto on a quotation from Ben Franklin—words that were spoken several hundred years earlier.

"The human condition is a curious one: We all face trials and tribulations throughout our lifetimes, and yet, when we hit a rough patch, we feel overwhelmed and alone," said Kayser. "It's as if we're the only people to have experienced that particular calamity. But bad stuff happens to everyone, and many of us respond with courage and fortitude." Most of the chapters in the book end with a quote that you've probably never heard before, but the words will leave you with a renewed sense of inspiration and motivation. As Kayser concludes, "Words are magical. They can transport you to other times, places, and worlds. Words are surely mankind's greatest invention." ■

Dan Nitowsky has more than 20 years of industry experience, including positions as a principal and executive with a Cleveland-area electrical distributorship. Currently director, business development, ED channel, for Kichler, Nitowsky has also served on the Board of Directors for NAED and the Electrical League of Ohio. He can be reached at dnitowsky@hotmail.com.

What's new at tEDmag.com?



OUR STREAMLINED FORMAT IS **BETTER**
BECAUSE IT OFFERS **MORE**.

MORE

Exclusive features covering topics critical to the industry:

- AmazonSupply threat to the supply chain
- Succession planning or how to hire the next generation
- Price of copper
- Value-added services

Information through our partnership with the Associated Press, allowing us to provide news on electrical distribution from around the world.

BETTER

Site Navigation

Search Functionality

Want to know what everyone else is reading at tEDmag.com?

© ISTOCK/THINKSTOCK

Higher education demands sustainability —and proof

Electrical distributors are uniquely skilled at defining solutions that maximize energy efficiency —and equally adept at proving the value of these solutions to decision makers. **by Jan Niehaus**

On college and university campuses across the nation, fads emerge and fade, but energy efficiency never goes out of style. The quest to lower power consumption and the resulting generation of greenhouse gases continues to energize students, as evidenced by the proliferation of energy-related competitions sponsored by a wide variety of stakeholders. For example, the Green Energy Challenge, launched in 2009 by ELECTRI International, invites student chapters of NECA to tackle real-world electrical problems and develop practical solutions, including budgets. Finalists present their proposals at the annual NECA Convention, where a jury that includes representatives of electrical distribution companies selects the winning school, which receives financial awards from ELECTRI International.

The Green Energy Challenge in 2014 called for an analysis of student union facilities and students' recommendations for energy-efficiency improvements. Technical requirements for students' proposals included a lighting system upgrade, submetering and feedback systems that elevate awareness of energy consumption, and a third energy-efficiency upgrade selected by students at each competing institution.

The Campus Conservation Nationals is another example. The Center for Green Schools, a program of the USGBC; the National Wildlife Federation; the Alliance to Save Energy; and Lucid, a privately held software company that provides information feedback on buildings' energy and water use, joined forces to sponsor this competition.

Now in its fifth year, the event—billed by USGBC as “the largest conservation competition for colleges and universities in the world”—is drawing hundreds of thousands of participants each year: students, faculty, and staff of two- and four-year colleges and universities. The contest is simple: Which team can produce the largest reductions of water and energy use in campus buildings over a designated three-week period?

These are technical challenges that tap into the core expertise of the electrical distributor.

Like the Green Energy Challenge and the Campus Conservation Nationals, the Sierra Club's “Cool Schools” eight-year-old program has gained widespread adoption. Its annual recognition of the “Top 10 Greenest Colleges” is eagerly awaited by public and

private institutions alike, including such prestigious competitors as Princeton, the University of California, Georgia Institute of Technology, Harvard, Texas A&M, Stanford, and Cornell.

In a recent *Sierra* (sierraclub.org) article, “Where Ideas Get Schooled,” Lifestyle Editor Avital Andrews described the fervor that fuels these successful national competitions:

“Universities are dense with passionate, creative idealists. There's time to care about the world and energy to act. Young people are willing to be bold and take chances.

“This is why colleges are at the forefront of sustainability,” she continued. “Their clientele demands it. Resolute students insist that their schools offer vegan food, divest from fossil fuel companies, shut down coal-fired power plants, and—not least—offer courses that enrich their understanding of the planet they hope to make their mark on.”

Student demand for modern, green, technology-equipped, and comfortable facilities is one of several trends identified by Jim Kadamus, vice president of Sightlines (sightlines.com), a research and consulting firm that maintains the largest database in the United States of information about university facilities.

“There is the expectation among students that they can work out in convenient, modern fitness centers; live in suite-style dormitories with private bathrooms; and access advanced technology campus-wide,” Kadamus said.

Another trend identified in Sightlines's 2014 annual report on the state of higher education facilities is the declin-

INDUSTRY NEWS



► **bptfittings.com renovated**

Bridgeport Fittings has introduced a completely renovated website with innovative resources that include a project submittal tool, a product detail page, an improved product finder, and a video library. Find it at bptfittings.com.

► **Galvan adds online tests**

Galvan Electrical Products has developed online test modules for two of its six “Safe Grounding Videos.” Find them at galvanelectrical.com.

► **Hubbell Lighting awarded**

Hubbell Lighting has received six 2014 Product Innovation Awards from *Architectural Products Magazine*. The company's Architectural Area Lighting, Beacon Products, Hubbell Industrial Lighting, Kim Lighting, Prescolite, and Sportsliter Solutions brands all received awards in the lighting and electrical category.

► **MaxLite LED named**

MaxLite's Architectural LED Torchière has been named to the “Energy Star Qualified Products” list.

► **Panasonic's innovation**

Panasonic Lighting Americas's Projection Lighting SpacePlayer was recently recognized as one of the most innovative products during the sixth annual Next Generation Luminaires Indoor Competition.

► **MAC-TS4 product awarded**

Vacuum Interrupters's MAC-TS4 vacuum interrupter tester recently won *Occupational Health & Safety* magazine's “2014 New Product of the Year” award in the Safety Monitoring Device category.

For up-to-date industry news and information, go to tEDmag.com.

SPECIAL
AD



Assessing Opportunities

The 5 reasons Why NSi. *by Pam Erickson*

Everyone loves a good story. This is a story about why I joined the team at NSi Industries and why it should matter to you as an electrical distributor. When presented with a new opportunity, what's the first thing you do? You begin your due diligence by checking the reputation of the company you're talking to and you ask around the electrical industry to others who have experiences with the company. In short, I checked references.

Reference #1: PRODUCTS

When I checked the 'references' for NSi Industries, what I discovered is that it is a company that is well known for its ease of doing business. I also discovered that NSi had a strong breadth and depth of electrical products with over 16 product categories, including contractor-preferred brands such as **Polaris™**, **TORK®** and **Easy-Twist™**. For those of you who are already distributor partners with NSi, this isn't a surprise to you.

Reference #2: SERVICE

NSi Industries, based out of Huntersville, NC, also boasts a **99.7% same day ship rate** from their distribution center in NC and from their network of stocking representatives across the US and Canada. This is an enviable shipping rate for any manufacturer in the electrical industry. To back up this best-in-class ship rate, NSi created their **Service Guarantee** program

with over 500 products that are guaranteed to ship within 24 hours.

Reference #3: MARKETING SUPPORT

With Marketing being one of my passions in life, it was important for me to delve into the history of NSi's **marketing support** and **merchandising** efforts. What I found is an award-winning team of talented and creative individuals who are flexible and responsive to the needs of NSi's distributor partners with customized solutions.

Reference #4: DEMAND CREATION

What's the best thing a manufacturer can do for their distributor partners? Create demand for their products in the marketplace. What I discovered is that NSi is investing in this **pull-through strategy**. New hires include industry professionals who add to the team of active NSi Application Sales Managers. This

knowledgeable team is aggressively calling on specifying engineers, contractors and OEMs in regions all across the US to bring business straight to your front door.

Reference #5: TRUE PROFITABLE PARTNERSHIPS

It's been said many times that we can do business with anyone, but we choose to do business with those we like and trust. My search for information about NSi included how profitable this line was for its partners in the industry. NSi's distributor partners had nothing but praise for the company, its **products' profitability** and the group of energetic and passionate (and most even used the word 'likeable') people at NSi.

With the strength of these references, the financial stability of the company, and their trajectory for profitable growth, both for NSi and our distributor partners, my decision was made. And now you know my **"Why NSi?"** story. If you'd like to hear more about our new Elite Partnership Program, or about NSi, please give me a call at 800.321.5837 or send me an email at pam.erickson@nsiindustries.com. I'd be delighted to hear from you.

ing number of high school graduates. In February 2014, the National Center for Education Statistics reported a sharp decline: Total enrollment in postsecondary, degree-granting institutions increased 45% from 1997 to 2011, a period of 14 years, but the projected enrollment increase from 2011 to 2022, a period of 11 years, is only 14%.

While competing for a smaller pool of increasingly demanding students, these institutions are facing a facilities crisis the likes of which American universities and colleges have never before

confronted. According to Kadamus, “More than 40% of the space on U.S. campuses was constructed between 1950 and 1975. Their life cycles are due or past due, and major systems, both electrical and mechanical, need to be repaired or replaced, or entire buildings need to be replaced.

“We had another campus building boom between 1990 and 2010, when enrollment started to go up again, this time with an emphasis on STEM programs: science, technology, engineering, and mathematics,” Kadamus continued.

“These buildings were of higher quality than the facilities of the 1960s and 1970s, many of them LEED certified, with more complex electrical and mechanical systems that require sophisticated maintenance techniques. There is huge pressure on facilities managers to deal with the capital needs created by these two waves of construction, which are coming due simultaneously.”

DIFFICULTIES IN FUNDING

Meanwhile, finances have never been tighter. Enrollment and tuition revenue

Q+A

A conversation with Rich Dove of Healthy Planet Partners. by Jim Romeo

GOING GREEN WITH DOLLARS AND CENTS IN MIND

Today's facility and construction market for education often includes a component of environmental design. This may come in the form of green technology, LEED certification, or another avenue of environmentally conscious inclusion.

Rich Dove is president and managing partner of Healthy Planet Partners in Greenwich, Conn. Healthy Planet Partners's mission is to “reduce the cost of operating today's facilities while increasing performance and achieving positive environmental change,” and its portfolio includes many educational facilities—such as public schools, charter schools, and other facilities such as sports stadiums for both secondary and collegiate levels. Here, Dove offers his insight into understanding this fascinating dimension of the education market:

Q: Is it difficult to make customers understand that the savings that can be reached by the implementation of certain renewables require investment?

A: It's a struggle, but that's why groups like ours exist. Most of the banks don't understand how to look at power projects; they understand how to look at real estate investments. They aren't there yet. This presents opportunities for companies like ours. We manage the up-front capital cost.

Q: Can you speak a bit about your view from the perspective of an electrical distributorship? Wherever there's a modification, there's someone doing work and they're going to be needing materials. They are part of the supply chain.

A: Absolutely. There's not only a huge amount of interest and opportunity for electrical distributors, but also they are really one of the most important parts about it. And it's not because they supply parts, but rather it's the reality that development is

a local business, and an established electrical distributor will have existing relationships with a huge book of customers. That means that the distributor has trust from that book of customers—and it knows how those customers are using power. It knows the age of their equipment. The distributor really has more insight into the day-to-day operations than someone like us, coming from a location far away and trying to understand the needs the facility would have on day one.

In other words, this is an opportunity to leverage what is the most important part of the client relationship here, which is the existing trust that these entities and the people that they are affiliated with have with the ultimate client base. That's what creates the investment opportunity for us; that's where there's a relationship on which we can move forward.

Q: Do you ever provide input into selection—a solar panel or solar technology, for example—with regard to brand manufacturer?

A: There's a term called “bankability,” which, in our world, is the balance between technical capability and financial stability. It all comes down to the risk profile of the asset. We are more likely to pursue a well-known solar provider with a solid balance sheet that is more likely to stand behind a warranty of its product than a first-time market player that has just come off its venture capital round even though its technology may be three times more efficient than the established one. Sometimes we give up what may be technical upside in exchange for financial security. ■

Romeo, a freelance writer based in Chesapeake, Va., writes on business and technology topics. Reach him at JimRomeo.net. Dove can be reached at rich@healthyplanetpartners.com.

are down, as are major gifts; endowments have taken a hit; and the financial support previously available from state and federal agencies is declining. "The facilities department is competing with faculty salaries and financial aid for limited funds," explained Kadamus.

According to the authors of the grim report *The Financially Sustainable University*, sponsored by Bain & Company, together with Sterling Partners (find it at bain.com), "Institutions have more liabilities, higher debt service, and increasing expense without the revenue or the cash reserves to back them up."

The answer to this conundrum, Kadamus noted, is "strategic thinking. If colleges and universities are going to continue to expand, they will need to be more strategic with their expansions and new construction, implement only those projects that support the university's mission, and reduce their footprint by knocking down old buildings that were

built poorly and are expensive to operate. Campuses will also need to focus on keeping up with maintenance so they don't add even more to the backlog of deferred maintenance."

Sightlines's *State of Facilities* report identifies two types of capital funding: annual stewardship and asset reinvestment, explaining: "Annual stewardship is the recurring annual funding that ensures that buildings will perform properly and building components will reach their useful life. We call this the cost of 'keeping up.' Asset reinvestment is the cost of addressing the backlog of repair and modernization of buildings—or 'catch-up' costs. When campuses allocate adequate resources to keep up with building life cycles, they defer fewer projects to their backlog and need less money to catch up. In fact, we have found that \$1 spent in stewardship avoids \$3 in capital reinvestment."

The role that electrical distributors

can play in supporting higher education through this critical time is to understand the pressures from stakeholders on all sides, recognize their extreme sensitivity to getting high value, and accept the burden of proof. "Administrators are saying, 'Prove to us that these facilities will run a lot more efficiently than before,'" said Kadamus.

Just as the electrical distributors of today are uniquely skilled at defining solutions that maximize energy efficiency, they are equally adept at proving the value of these solutions to decision makers in every sector—including higher education. ■

Niehaus, president of *Communication by Design* (communicationbydesign.net), serves the electrical industry by creating marketing communications and custom training programs. She can be reached at 314-644-4135 or Jan@CommunicationByDesign.net.

electro expo 2015



powering innovation + technology

Exhibit Space Available
Complete booth packages (10'x10')

Educational Conference
FREE Credits in Continuing Education Classes
Industry Association Support: AIA, BICSI, Builders Exchange, Green Energy Ohio, IAEI, IESNA, OCILB, OBBS, Professional Engineers, USGBC

Trade Show and Educational Conference
March 11 & 12

Cleveland Convention Center, Cleveland, OH

The region's premier trade show and educational conference for electrical, lighting, clean energy and low voltage systems industry!

Hundreds of Manufacturers and Attendees

Participation will offer opportunities to showcase products and services to a targeted audience of nearly 4,000 industry decision makers

The 2015 Electro Expo is proudly sponsored by:



Corporate Sponsors:



Show Management:
The Electrical League of Ohio
20575 Center Ridge Road, Suite 117
Rocky River, OH, 44116
(440) 333-5040

For more information
visit tEDmag.com/InfoCard

www.electroexpo.org





The hard sell vs. the soft sell

The best salespeople have to develop both the hard and soft side of their selling approach. by **John Chapin**

On the surface, this question of whether to use the hard sell or the soft sell may seem like a no-brainer, so let's begin by defining both of them. A hard sell is not about hammering someone into doing something that isn't right for him or her. Rather, it's about being direct and getting prospects involved in what they need, cutting through fear, denial, and other roadblocks that can stop a sale. Likewise, a soft sell isn't about using touchy-feely language and letting the prospective customer completely control the process. Rather, it's about listening with empathy and truly understanding prospects and their needs.

Keeping those definitions in mind, a fine line exists between the soft sell and the hard sell, and it's important to learn when to cross it. The problem with most salespeople is that they are either hard sell or soft sell, iron fist or velvet glove, not both. The key to success is to be able to use both approaches—and know when to use each one.

As a general rule, the salesperson should be soft in the beginning of the relationship. During this "getting to know the prospect" phase, the salesperson is building rapport and wants to be

soft and slow and listen a lot. Once there is a full understanding of what the prospect needs, it is then time to be direct and make sure he or she gets what is needed. At this point, cut through everything else and push if necessary to get to the sale.

The type of person the prospect is will also dictate whether a hard sell or a soft sell is needed and when to cross the line from one to the other. With a hard-nosed, straightforward, no-fluff individual, going from a soft sell to a hard sell will happen faster than with someone

who is more laid back, easygoing, and slower in his or her approach.

In some cases, there will never be a need to cross the line between soft sell and hard sell. These will be people with whom the salesperson has a great connection. They will see the opportunity and will know what they have to do. They will be led directly down the path toward the sale, and it will seem as natural as taking a relaxing walk on the beach. In other cases, it will be necessary to go straight to a hard sell. These are clients who need a product or service—and know they need it—and yet fear is holding them back from doing what they know needs to be done. At that point, skillfully pushing is necessary.

Another issue is that both hard-sell-only and soft-sell-only salespeople vehemently defend their style and say it is the only way to go.

The hard-sellers out there may ini-

tially make more sales and have some level of success, but to be hard sell all the time is tiring, will lead to canceled sales, and will hurt repeat and referral business. Also, people who are hard sell all the time are focused on the sale first and the needs of the prospect second. Remember, the prospect always comes first.

On the other hand, soft-sellers will not only miss many more sales, but also prevent people from enjoying the benefits of their products. For example, consider a married dad of two young children. His insurance agent approaches him about life insurance. The agent knows he needs it—and the young father knows he needs it—but he's uncomfortable committing and the agent doesn't want to push. Three months later, the father dies in a car accident and his family is unprotected. His widow has to sell the house, uproot the kids from their school and life, and get three jobs to make ends meet—all of which could have been prevented if the agent had the sales skills necessary to protect the family.

While this example may seem extreme to those who sell something other than life insurance, a salesperson who is sold on his or her product and knows people are better off with it has an obligation to push when someone has a need to buy that product.

FOCUS ON THE FOLLOW-UP

Another area affected by selling style is follow-up. Most soft-sell people will follow up once or twice, if they follow up at all. In most cases, those who follow up once or twice will not make the sale as the average sale happens after the fifth contact. On the other hand, most hard-sell salespeople tend to follow up too much and too early. This approach will irritate most everyone and make selling more difficult.

All considered, it is better to follow up too early and too often and push a bit too much rather than not enough. The salesperson who recently called me seven times in seven days made a sale, while the person who followed up only

once didn't, even though I wanted his product more. And I think I am probably like most buyers.

The bottom line is: The best salespeople have to develop both the hard and soft side of their selling approach. As with every other area in selling, only by practicing can a salesperson get good at using both approaches and knowing when to use which one. ■

Chapin has 24 years of sales, customer service, and management experience and is an award-winning sales speaker, trainer, and coach. He is also a sales rep in three industries and the primary author of the gold-medal-winning "Sales Encyclopedia." To reach Chapin, find a free white paper on what it takes to be successful in sales, and subscribe to his monthly newsletter, visit completeselling.com.



The LED retrofits you need. The features you've hoped for.



- Low voltage 3 and 4 inch 12 volt models, 35 to 50 Watt replacement
- 4 inch models, dimmable and ENERGY STAR certified
- 5/6 inch models, dimmable, ENERGY STAR certified and rated at 1180 lumens
- All have damp and wet location options available
- All available with baffled reflector or directional gimbal ring
- 90 CRI options for CEC compliance
- All 3000K
- All up to 40,000 hours

Satco. Lighting the future for the past 50 years.

Experience all of Satco. Dallas Market, January 14-18, 2015, Suite 4942.

Call 800-437-2826

Consult www.satco.com for a list of compatible dimmers.



©2014, Satco Products, Inc.

National Toll-Free:
800.43.SATCO
(800.437.2826)
www.satco.com



Distribution Centers:
New York, Florida,
Texas, Washington,
California, Puerto Rico

Satco Products Inc.
110 Heartland Blvd.,
Brentwood, NY 11717
631.243.2022
Fax 631.243.2027

For more information visit tedmag.com/InfoCard

Six shining marketing efforts

A pair of winning Direct Promotion entries and four engaging Events make up this month's 2014 Best of the Best Awards coverage. **by Joe Nowlan**



Despite its success, North Coast Electric (division: distributor over \$200 million) had a problem: explaining to its customers that while it was an electrical distributor, it also sold a varied and extensive line of tools. The Seattle-based company created its *Tool Tracks* promotional catalog to help remedy the

problem. "One of the challenges we have as an electrical distributor selling tools is the believability that we can compete with tool houses and big box stores," said Alex Davidson, a company spokesman. "Our *Tool Tracks* promotional catalog creates awareness with our current customers that we do sell tools and that our pricing is competitive."

North Coast Electric was able to offer its line of tools and tool-related items at a reduced cost for a period of time to promote customer awareness.

In addition, the *Tool Tracks* catalog—published three times a year and sent to more than 4,500 customers—carried company news, customer service guarantees, and links to educational and instructional videos.

Tool Tracks was used to promote 78 new items. Of those that had not been stocked previ-

ously, 65 were added to North Coast's inventory.

• **Encore Wire.** With a new aluminum plant ready to open, Encore Wire (division: supplier over \$250 million) needed to make an appropriate announcement while taking advantage of the tie-in opportunity to publish its new aluminum catalog.

"With the opening of the new aluminum plant coming up, we knew we needed to make a splash when releasing the aluminum catalog," said Lindsay Tawney, marketing assistant. "Our foundation was built on copper so our goal was [for] a high-impact, very informative piece."

The aluminum catalog featured product illustrations presented as 3-D objects. Five product spreads were printed on pearlized paper stock that resembled the sheen of aluminum.

"The bright colors of the machinery,

coupled with the shine of the aluminum, create a luminous effect, giving the catalog a 'wow' factor," said Tawney. "With the release of our aluminum catalog, both in print and online, our customers learned of the breadth of our



From left: "North Coast Electric believes it's important that its customers know that their favorite electrical distributor stocks those tools, and the results show that this is an effective way to do so," noted the Best of the Best judges. "We also like that there are links to educational how-to product videos in the catalog." Right: Of Encore Wire's winning entry, the judges noted, "We like that Encore carried the aluminum-look theme throughout the piece—from the cover to the pearlized stock. This represents a bold move into a new category for the company and this beautiful catalog is the perfect way to let customers know."



new aluminum product offering."

The sales results were positive, as was the reaction to the catalog itself. Encore Wire's fourth-quarter aluminum sales grew, representing 6.9% of net

sales in Q4 2013, up from 3.6% in the previous year.

ENGAGING EVENTS

• C.N. Robinson Lighting Supply.

Keeping customers updated on the latest lighting developments and products was crucial for C.N. Robinson Lighting Supply (CNR; division: distributor under \$25 million). To this end, customizing a trade show seemed like the best way to educate not only its loyal customers, but also prospective customers.

The "Driving the Green Lighting Technology Tradeshow" was created to focus on various local utility incentives and how the Baltimore-based distributor's utility incentive app management services can help.

The trade show was designed for "90 key [customer] targets that would focus on local utility incentive programs, introduce and showcase CNR's free incentive management service, and display only incentive-qualifying products for all applications from CNR's preferred suppliers," explained Penny Zibrowski, business development and marketing associate.

CNR drew up a list of key decision makers to invite and sent out weekly emails and personally delivered invitations to register.

The company chose a theme that would catch the audience's attention: "Golf and Green Lighting." Each preferred supplier furnished co-branded golf-related giveaways and door prizes.

The email invites had an average open rate of 68%. At the trade show, CNR's sales staff scheduled 30 on-site appointments, resulting in 12 booked projects.

Customer feedback was enthusiastic: "It was definitely worth the time away from the office," praised one attendee. "I learned about new lighting alternatives, financial options, and rebates with a catalog I can take back to the office."

• **Werner Electric Supply** (division: distributor \$25 million to \$200 million) wanted to re-emphasize its value and product offerings to its customers. To

achieve this goal, Werner's marketing department decided to hold the Werner Electric Solution Expo in April 2013.

"[We] saw an opportunity to showcase Werner Electric Supply as a full-solution distributor," said Nycole Schneider, marketing manager. "The expo showcased premier vendors' products and services along with Werner's solutions and capabilities for its customer markets."

The expo would serve as a vehicle to underscore the Cottage Grove, Minn., distributor's solution-provider credentials while informing its customers of the newest product developments and services. But before it could be held, a great deal of internal educating was necessary for Werner employees.

Werner's departments were provided tools and marketing data via biweekly expo-related webinars and special "how-to-engage-customers" guides.

Attendees received specially prepared brochures that outlined the expo events. Participating suppliers received their own informational packets with tips on exhibiting new products, registration info, and the layout of the exhibit space.

The expo itself was very well received and attended. In all, more than 550 customers came to meet with 54 vendors and Werner employees.

In survey responses, the event drew a 69% satisfaction rating, with 98% of respondents saying they would be "very likely to attend again."

• **State Electric Supply.** Like many of its customers, State Electric Supply (division: distributor over \$200 million) was concerned about the various violent events that had taken place on school properties and campuses nationwide.

The Huntington, W.Va., distributor heard from school administrators, parents, and faculty about safety and security measures at their buildings.

State Electric's data communications division contacted many of its education customers about assisting in making an evaluation of the schools' safety measures and existing equipment.

Put Your Career on the Fast Track.

EPEC gives you the opportunity to pass the competition.

The industry's premiere sales and product training course has been updated.

Visit www.naed.org/EPEC to learn more.



NATIONAL ASSOCIATION OF
ELECTRICAL DISTRIBUTORS

Driving the Green Lighting Technology Tradeshow
November 6, 2013
9:00am-4:00pm

TEE UP THE TECHNOLOGY TRAINING
9:00am-11:00pm (Lunch is served & bring us back!)

Session 1: Energy Saving Lighting Controls Code Compliance
9:00am-11:00am
Attendees will receive a complimentary lunch for themselves and their colleagues.

Session 2: Today's Energy Efficient Interior & Exterior Lighting Solutions & Strategies
11:15am-12:45pm
Come see our new lighting solutions.

Session 3: Lighting Technology Energy Efficient Workshop
1:00pm-3:00pm
Attendees will receive a complimentary lunch for themselves and their colleagues.

Driving the GREEN LIGHTING TECHNOLOGY TRADESHOW
3:00pm-4:00pm (Lunch is served & bring us back!)

COMES WITH FREE Continental Food & Beverage Buffet & Valuable Golf Raffle Prizes

Training Session Seating is Limited & Filling Up Fast! Register Today!
Click Here to go to www.cnr.com/news.html

CNR is proudly partnering with these industry leaders:
PHILIPS SMARTIES, SIMECO, VEDLIA, pepco, and others.

"Through feedback from our customers, the decision was made to host safety seminars at six strategic branch locations," explained Laurie Bohren, company spokesperson and graphic designer. "The seminars would educate customers about security information, products, and available services."

State Electric had two objectives for these seminars: to show that the company is a security solutions provider and a reliable source of

safety information and to contribute toward increased sales.

Customer feedback was positive: "With an aging security infrastructure, we knew it was time to look at some updated options for our facility," wrote one educator. "We

had an existing relationship with State Electric so we knew we were going to receive the highest level of service and quality products..." After the seminars, State Electric's overall datacom division had a sales uptick in business of 6.87%, and its video and surveillance sales grew by nearly 130%.

• **IDEAL Industries** (division: supplier over \$250 million) arrived at a successful approach for running its popular semiannual seminars.

The seminars focused on classroom sessions in addition to factory tours that included the "pseudo showroom" at IDEAL's headquarters.

While intensive, the classroom work was especially successful. "The classroom training focuses on the four main advantages of proper product merchandising: increasing sales, increasing profits, increasing efficiency, and increasing customer service," explained Liz Koley, marketing support specialist.

Other topics covered during the seminar included the best use of signs. Tactics were discussed that would increase what a visiting customer would notice during a store visit.

"Signage overcomes the barrier of your customer's reluctance to ask questions," explained Koley.

Another popular educational session dealt with various sales promotions during which customers were instructed in how to conduct effective and profitable sales and product promotions.

Additional classroom discussion topics included display and store design, competition, and loss prevention.

These seminars have become popular events, with many customers making return visits at least once each year. Seminars are financed by IDEAL and, while not supplier specific, "are geared toward educating our distributors on the proper methods of merchandising products," said Koley. ■

Nowlan is a Boston-based freelance writer, editor, and author. Reach him at jcnolan@msn.com.

SAFE SCHOOLS.

Questions about surveillance security measures and access control that is necessary for the protection of the student population?

JOIN US FOR ONE OF OUR UPCOMING SEMINARS
No need register by attending the Classroom Account Manager class for each seminar.

February 26
9am - 12pm
State Electric Supply Co.
455 126 Street
Dunkirk, WI
James Stewart
304.765.3600
james.stewart@stateelectric.com

February 27
9am - 12pm
TBA
State Electric Supply Co.
181 Oak Cottage Lane
Huntington, WI
Clary Chelton
304.847.5200
clary@stateelectric.com

February 28
9am - 12pm
State Electric Supply Co.
455 126 Street
Dunkirk, WI
James Stewart
304.765.3600
james.stewart@stateelectric.com

Real Time Identification Authentication
Attendees will receive a complimentary lunch for themselves and their colleagues.

Revolutionize School Integration Solutions
Attendees will receive a complimentary lunch for themselves and their colleagues.

Security Solutions
Attendees will receive a complimentary lunch for themselves and their colleagues.

STATE ELECTRIC SUPPLY CO.
CUSTOMER FOCUSED. SECURITY DRIVEN.

KANTECH

www.stateelectric.com

From top: The Best of the Best judges liked how "CNR ran a good event with good results; this trade show was a cohesive effort packed with useful information." Of State Electric's winning entry, the judges noted, "This was a very comprehensive event with impressive results. The subject matter is very topical and addresses a real problem in our society and

a need of State Electric's customers." The judges liked Werner's entry because "Werner let the content speak for itself. There were no gimmicks but they still got the turnout." And of IDEAL's winning entry, the judges noted, "We really like that these are non-supplier-specific seminars. It shows that IDEAL is interested in more than just promoting its own products."

YOU'RE INVITED

WERNER ELECTRIC'S SOLUTION EXPO TRAINING & PRODUCT SHOW

Saint Paul RiverCentre • 175 Kellogg Boulevard West (Level 2) • April

Sponsorship Package Options:

- Registration on Facebook page
- Registration to customer with the price
- Logo and recognition on floor to customer with information about content

\$100 Networking Event Content Sponsorship (Quarter) (Quarter) (Half)

- Registration on website
- Logo on signage of event registration banner

\$1,000 Networking Event Content Sponsorship (Quarter) (Quarter) (Half)

- Logo on event booth area
- Logo on signage of event registration banner
- Logo on signage of event registration banner
- Ability to post information on program materials with customer registration page

\$1,000 Networking Event Content Sponsorship (Quarter) (Quarter) (Half)

- Logo on event booth area
- Logo on signage of event registration banner
- Logo on signage of event registration banner
- Ability to post information on program materials with customer registration page

WERNER ELECTRIC
SOLUTION EXPO TRAINING & PRODUCT SHOW



~~Under~~ Promise ~~Over~~ Deliver

Learn more about our commitment to excellence at www.leviton.com/values

For more information visit tEDmag.com/InfoCard



**PRODUCT
PREVIEW:**
10 Trends to Watch
in 2015



By Susan Bloom

THE HIP URBAN DICTIONARY defines the term “trending now” as anything currently in vogue or growing in popularity or prevalence among consumers, but recent developments prove that this widely used expression applies as much to the electrical products industry as it does to pop culture. From new products that improve quality, efficiency, and safety to IT systems that enhance connectivity in our increasingly digital world and creative new services that promote ease of doing business, electrical products operate in a dynamic arena that demands a distributor’s superior vision, targeted strategies, outstanding operational capabilities, and exceptional customer service skills to be successful. To kick-start your 2015, we invited a number of seasoned executives from among the industry’s most renowned electrical product manufacturers to share their perspectives on what will be trending in the coming year and what they see “going viral” down the pike.



1. "QUALITY FIRST" FOR LEDS

"The biggest trend in lighting products this year will be a move away from what has been a nearly exclusive focus on energy efficiency of LED technology," predicted Karen Lee, head of applications marketing at OSRAM Sylvania. "While the pace of improvement continues to be astounding, as an industry we're taking a deep breath and stepping back to recalibrate with a broader definition of expectations for quality. Specification details such as color quality and photometric distribution will be the points of differentiation between acceptable products and excellent products."

Ross Barna, CEO, RAB Lighting, agreed, noting that the DesignLights Consortium (DLC) will continue to play a significant role in driving demand for LED lighting, especially those products that meet the highest performance standards. "After the recent upgrade to V2.1, DLC is considering additional upgrades that will result in a manufacturer focus on improving product performance," Barna said. "This will shift resources away from purely cost reduction efforts."

2. HIGH-OUTPUT LEDS

Looking for a good bet in 2015? "High-output LED applications such as replacements for 400W to 1,000W metal halide sources are selling like crazy," Barna said. "The payback on replacing these energy-guzzling fixtures is rapid."

3. LONG LIFE

According to Carla Brecht, services channel manager, Schneider Electric, end-users are beginning to invest more time and money in life extension products and services, which presents a significant opportunity for distributors to provide additional value-added services and solutions to both end-users and contractors while increasing sales. For example, she said, "We're seeing increased activity with industrial end-users regarding preventive maintenance plans for new and existing equipment, a proactive approach that has led to an increase in both spare parts sales and service sales based on recommendations from maintenance reports." As demonstrated by an increase in extended warranty activity/sales in both new construction and existing installations of electrical distribution equipment, she added, "This overall trend will continue."

4. REAL-TIME CONNECTIVITY

Driven by the need for a streamlined, digital process that enables contractors to quickly respond to the issues and demands they face on a daily basis, "We're seeing an influx of products that provide mobile integration and cloud connectivity to give contractors the ability to work in real-time with greater access to information and resources," said Tim Perek, director, digital customer experience, Schneider Electric.

"Contractors want us to help them do business faster and more effectively," he added. "They want products that support them on and off the job with quick and easy access to the products, resources, and information they need when they need it. The ability to always be connected and access real time in-

formation to build faster quotes, quickly source products, track orders, and access expert advice on demand is critical to helping them remain competitive."

5. KEEP IT SIMPLE

"In the coming year, it's all about simplicity," predicted Brian Donlon, sales vice president, North America, Lutron Electronics. "We're going to continue to see innovations that simplify how products and solutions are ordered, installed, set up, and ultimately operated by the end-users. Wireless technology will play a major role in simplifying installation and setup, and technology that minimizes compatibility issues between controls and load types will make it easier than ever for the end-user to order the right product and feel confident that it will continue to perform well. Overall, products that are simple and flexible in their design, installation, and setup will win in 2015."

6. SMART SERVICES AND SOLUTIONS

According to Donlon, both pre- and postinstallation services are becoming increasingly important elements of a project. "Preinstallation design support and compatibility services help minimize risk and ensure that the right products are chosen for the job and are going to work as expected," he said. "Postinstallation services such as system optimization, training, and extended warranties help make sure that customers are satisfied and get the most out of their system."

7. DESIGN TOOLS

"Numerous studies have indicated impressive growth in the adoption of Building Information Modeling (BIM) as a tool used by architects, engineers, and contractors, and this growth looks to continue for several more years," noted Kraig Kasler, vice president and general manager, Eaton's Cooper Lighting business. "Manufacturers committed to providing BIM-ready content in support of their products are providing a valuable asset that creates efficiency, reduces errors throughout the construction process, and assists in energy calculations and forecasting," he said, adding that savvy distributors will familiarize themselves with these products.

8. CONTRACTOR-READY SOLUTIONS

Bob Crain, director of marketing, Legrand EWS, believes that strategically designed products and value-added services will definitely win the day with contractors in the new year. "Because more than a third of electrical contractors' time is wasted looking for products, unpacking them, and moving and configuring them so that the work they were hired to do—installing them—can finally be done, they want products preconfigured and ready to install with as little packaging as possible," he said.

In conjunction with that trend, Crain also foresees a necessary transformation in the role of the distributor. "With so much more information available than ever before, the end-users, specifiers, and contractors who are wading through it need more assistance to get the right product set installed and operational," he added. "In support of that, distributors need

to get to know their customers better, understand their issues and what keeps them up at night, and direct them to products that make the entire project run more smoothly. Distributors need to be sales consultants that understand the customer's needs and recommend the best solution."

Donlon concurred. "Distributors are shifting from product providers to solution providers," he said. "They're becoming the consultative, go-to resource for customers that want a solution that they know is going to work—not just parts and pieces. Distributors that do this will be able to provide more value and develop better relationships with their customers—ultimately achieving greater margins."

9. SERVICE-LEVEL AGREEMENTS

"Customer needs are driving a closer working relationship between manufacturers and distributors and they're utilizing their business analytics to be more specific in detailing their requirements," said Jim Wator, director of strategic channels, Panduit.

According to Wator, "These customer requirements may include service-level agreements for delivery, extended price commitments, stock availability, and on-site services—and failure to meet them may carry financial penalties. Many of these service-level commitments have responsibility and ownership by both the distributor and the manufacturer, and this interdependence creates the need for a greater understanding of shared capabilities by both parties."

Wator added that distributors and manufacturers are also increasingly developing services based on opportunities to jointly develop mutually beneficial programs that meet customers' changing needs. "These provide a greater value offering for customers and also create positioning earlier in the sales cycle through assessment services while prolonging the sales cycle through the sale of postinstallation services such as monitoring or training," he said.

10. MORE AND BETTER CONTROL

Barna and Lee forecast an increased demand for lighting controls such as occupancy sensors, bilevel lighting, and dimming, in part driven by utility rebates and legislation such as *California Title 24*. "A huge trend this coming year will be in the controls space," Lee noted. "Not only will we see progress in areas that we conventionally consider for controls—such as systems for scene control, energy management, and integrated building systems—but also options for incorporation into



"Customer needs are driving a closer working relationship between manufacturers and distributors and they're utilizing their business analytics to be more specific in detailing their requirements. These customer requirements may include service-level agreements for delivery, extended price commitments, stock availability, and on-site services—and failure to meet them may carry financial penalties."

— JIM WATOR, director of strategic channels, Panduit

'smart systems' will expand greatly as well."

"The major trends we see are in flexible, scalable systems—that may or may not be connected to the building network—and compatibility of controls and light sources," Donlon agreed. "As the market continues to shift toward new light sources, we'll see a movement toward products that are compatible with multiple new load types, particularly LEDs," he said. "At the same time, demand for reliable RF controls is increasing rapidly as a means to greater flexibility and faster, easier, and lower-cost installation."

"LED lighting and the integration of lighting controls will continue to take center stage in the future," Crain said. "In the past, lighting upgrades were based largely on energy effi-

ciency, but there's now a big shift toward the integration of services for comfort. With the incorporation of lighting, daylighting, window shades, and HVAC together, the user experience has become much broader and is increasingly driven by aesthetics. Lighting control has become much more than just a dimmer, and the user interface with the control and design aesthetics of the product is as important as the light itself."

Kasler agreed. "Designs that move the luminaire beyond the form factors used for traditional light sources and the integration of more controls functionality through means such as occupancy sensing and daylight harvesting directly into the fixture to increase energy efficiency and reduce commissioning costs are definitely top trends," he said. "The time is now for intelligently controlled LED lighting, through which customers can enjoy a lower total cost of ownership, improved aesthetics and light quality, drastically reduced energy costs, and control functionality that they simply couldn't achieve with traditional light." ■

Bloom has more than 20 years of experience in the lighting and electrical products industry. She can be reached at susan.bloom.chester@gmail.com.



1. MC LUMINARY CABLE

AFC Cable Systems's MC Luminary cable offers a method to deliver both power cables and control cables under one UL-listed MC cable, providing an organized appearance while significantly reducing labor and installation time by up to 30%, according to the company. The cable is manufactured in accordance with *UL66*, *UL83*, and *UL1569* standards and complies with *NEC 330* and *NEC 725*.

For more information visit tEDmag.com/InfoCard

2. 0-10V DIMMER SENSOR

Lutron Electronics's Maestro dimmer sensor combines 0-10V dimming and sensing into one simple, cost-effective solution to meet energy codes. The new sensor dimmer uses Lutron's XCT passive infrared sensing technology and smart, adaptive settings to provide reliable sensing and optimized dimming performance. Installation is simple with miswire alerts, no neutral required, and easily adjustable settings.

For more information visit tEDmag.com/InfoCard

3. EV CHARGING EQUIPMENT

Siemens's VersiCharge line of EV charging equipment is a versatile and easy-to-use system available to electric vehicle owners. These Level 2 (30A/240VAC) charging stations include flexible installation options, amperage control, and intuitive user controls. The system is available in two configurations: hardwire for indoor use only and universal, which can be used indoors and outside.

For more information visit tEDmag.com/InfoCard

4. LED ROADWAY LUMINAIRE

Eaton's Cooper Lighting Business's Verdeen LED roadway luminaire combines optical performance, energy efficiency, and versatility to meet the requirements of roadway, area, and site applications. Advanced AccuLED optics deliver uniformity and budget-conscious operating costs. The luminaire is available in three optical distributions and in lumen packages up to 8,500 lumens to replace high-pressure sodium fixtures. It is offered standard in 4000K with 3000K and 5700K options.

For more information visit tEDmag.com/InfoCard

5. IMAGING IR THERMOMETER

FLIR Systems's TG165 imaging IR thermometer combines an IR spot meter with the company's exclusive wafer-formed Lepton thermal sensor. According to the company, the combination delivers the ability to quickly see where it's too hot or too cold, provides more reliable readings, and saves images and measurements that can be downloaded for professional documentation and reports.

For more information visit tEDmag.com/InfoCard

6. BOX EXTENDER WITH LARGER FLANGE

Arlington Industries's single-gang box extender with larger flange covers miscut wall material, accommodates midi- or maxi-cover plates, and extends set-back boxes up to 1½". It levels and supports (eliminating the need to tape the receptacle to prevent arcing), complies with *NEC 2014* for set-back boxes, and is UL and CSA listed with a two-hour fire rating.

For more information visit tEDmag.com/InfoCard

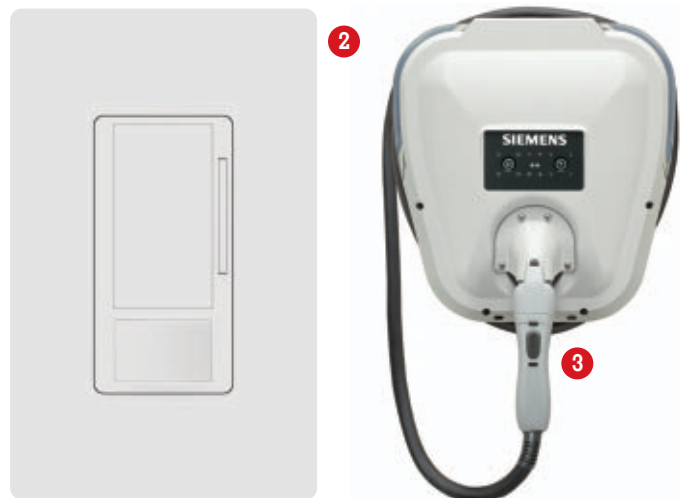
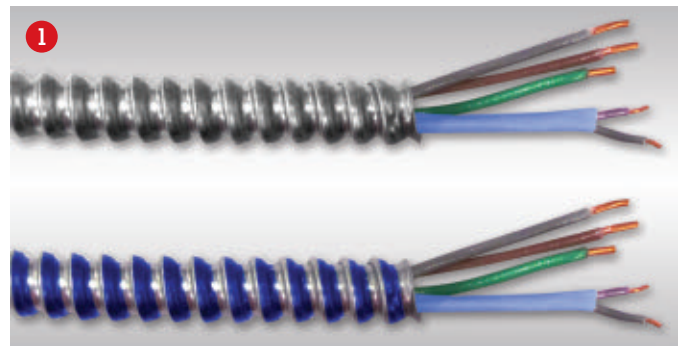

7. LIGHTED PLUGS & CONNECTORS

Leviton Manufacturing's line of residential plugs and connectors has been expanded to include a lighted model for added convenience while in use. The green neon light within the clear body of the device indicates that power is flowing through the cord. A solution for a wide range of indoor applications, the plugs and connectors are rugged and easy to wire, according to the company, and feature brass plug blades and connector contacts for maximum conductivity.

For more information visit tEDmag.com/InfoCard

8. DRV LED RETROFIT KIT

Terralux's DRV LED retrofit kit allows users to quickly upgrade any pin-based CFL downlight using a vertically mounted lamp. The downlight uses less than half the power for the same light, delivers 80+ CRI, and provides more than 60,000 hours of life.

For more information visit tEDmag.com/InfoCard

9. 68W LED WALLPACK

NSi Industries's WP68LED is designed to replace inefficient outdoor lighting sources with high efficiency and better light for retrofit and new construction. Available in cutoff and noncutoff, the wallpack meets federal, state, and local energy-efficiency codes in applications like multilevel parking facilities, office complexes, large manufacturing facilities, loading dock doors, and highway tunnels.

For more information visit tEDmag.com/InfoCard

10. ANGLED PLIERS & CUTTERS

KNIPEX's German-made Orbis angled pliers and cutters are suitable for a versatile range of applications. The 25° comfort angle makes each tool a natural extension of the user's hand and allows better sight lines when working in confined spaces, providing the user with the ability to see what is being grabbed, pulled, and cut.

For more information visit tEDmag.com/InfoCard

11. UNINTERRUPTIBLE POWER SUPPLY

SolaHD's S4KC UPS systems provide continuous uptime for connected equipment, with capacity and battery backup delivered in cabinets that use 2U to 6U of rack space. The UPS's online features and slim enclosure provide protection for applications such as industrial computers, automation systems, robotics, and process controls. Qualified models include 120V input for 700VA, 1,000VA, 1,500VA, 2,000VA, and 3,000VA capacity and 120/208V input for 6,000VA and 10,000VA capacity. Additionally, these models have the EPA's Energy Star Version 1.0 qualification.

For more information visit tEDmag.com/InfoCard

12. LIGHTING CONTROL

Lutron Electronics's GRAFIK T dimmer is a new lighting control that combines advanced Lutron touch-dimming technology with minimalist design. One touch on the LED lightbar sets the lighting level, and an illuminated LED lightbar with softly lit white LEDs indicates the light level. GRAFIK T is available in more than 40 colors and finishes, including metal and glass.

For more information visit tEDmag.com/InfoCard





13. PREASSEMBLED HANGING PLATE

Orbit Industries's model BCHS-6S prefabricated box and conduit hanger support plate is manufactured from 15-gauge steel, fits up to 6x6" boxes, and has one point of attachment (rather than the multiple points used in a traditional installation). The hanging plate is preassembled for vertical or horizontal mounting and includes stamped markings for guidelines.

For more information visit tEDmag.com/InfoCard

14. HEAT DISSIPATION TUBE GUARD

Engineered Products Company's T5 HD Series tube guard with heat sink expedites installation by eliminating the process of prerolling two heat sinks per tube guard. When combined with the "vented" end caps, the heat sink lowers the inside temperature of the tube guard by approximately 30°F, making it a convenient solution for tube guard installations, which are frequently used to prevent damage caused by fluorescent lamp breakage.

For more information visit tEDmag.com/InfoCard

15. IP VIDEO CAMERA

Toshiba's K-WR05A IP video camera has a wide-angle, prefocused lens and IR LEDs, making it ideal for outdoor wide-area surveillance. With a 110° viewing angle, 1080p HD resolution, and IR LEDs, the IK-WR05A can cover almost all surveillance requirements. The IP66-rated housing and small form factor make the camera environmentally and visually appealing.

For more information visit tEDmag.com/InfoCard

16. CABLE TESTERS

IDEAL Industries's VDV II Series of easy-to-use cable testers check the integrity of copper cables commonly found in domestic, commercial, or industrial VDV installations, including telephone wiring, data network, and video/security cabling. The advanced wiremap engine accurately displays complex wiring faults instantaneously while the integrated "Time Domain Reflectometry" simplifies troubleshooting and improves on-site productivity, according to the company.

For more information visit tEDmag.com/InfoCard

17. FOAM WIRE-PULLING LUBRICANT

Klein Tools's foam wire-pulling lubricant works differently from gels or waxes because instead of being spread onto the wires, the lubricant is applied directly into the conduit—filling the conduit and coating the wires as they are pulled through. The foam won't drip out even if it is used in vertical conduit, and the lubricant wipes away clean and won't leave stains on hands, clothing, or carpet.

For more information visit tEDmag.com/InfoCard

18. DUAL-FUNCTION AFCI/GFCI CIRCUIT BREAKER

Siemens's AFCI/GFCI circuit breaker combines two state-of-the-art technologies into one device that allows for easier installation and increased cost savings. According to the company, the breaker is first in its UL class to include a self-test and lockout feature that automatically tests itself, adding extra protection and safety.

For more information visit tEDmag.com/InfoCard

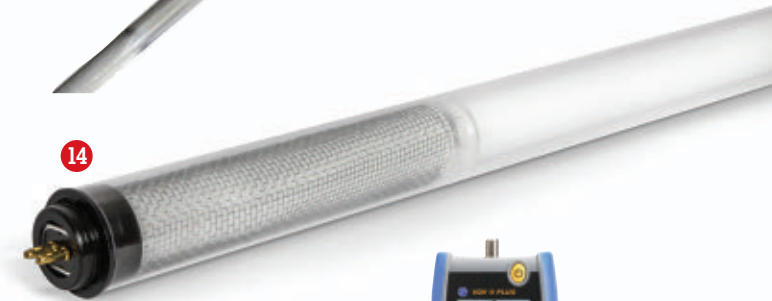
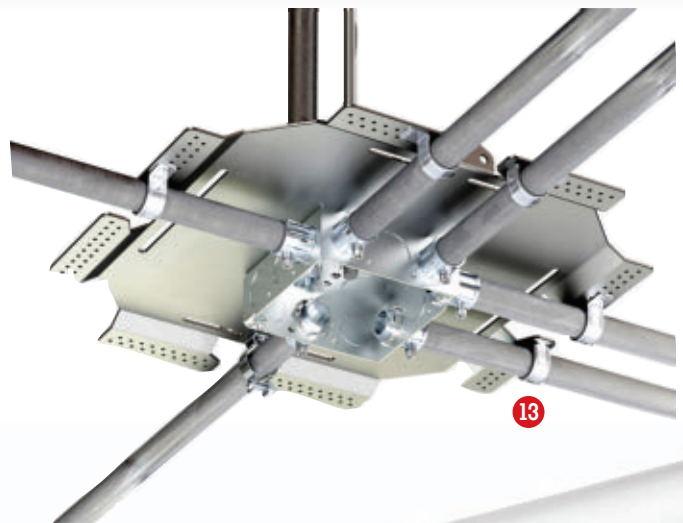

19. EMBEDDED MICRO METERING MODULE

Siemens's SEM₃ embedded micro metering module is a modular metering solution for energy monitoring, data analysis, and subbilling applications. Designed for multifamily, commercial, and industrial applications, the SEM₃'s design allows for low-, medium-, and high-density metering requirements to be met using only a few standardized components. Pre-engineered to integrate into new Siemens panelboards and switchboards, the SEM₃ has also been designed to be implemented in OEM and retrofit applications.

For more information visit tEDmag.com/InfoCard

20. DATACOM SNIPS

Southwire Tools's ESP-1 professional datacom snips feature patent-pending spring-loaded blades that provide unprecedented control and a comfortable handle that provides a secure, comfortable hold.

For more information visit tEDmag.com/InfoCard

21. EXPANSION/DEFLECTION COUPLING

Thomas & Betts's nonmetallic expansion/deflection coupling improves safety and reduces installation time for joining rigid PVC conduit that is subject to movement in any direction at structural joints. The coupling, which is manufactured in the United States, is up to five times faster to install and has versatility that enables a five-to-one reduction in SKUs, according to the company.

For more information visit tEDmag.com/InfoCard

22. 4" SQUARE TRIMS

Nora Lighting offers its 4" diecast aluminum square trims for its LED Diamond II 90+ retrofit series. The trims are designed for use with standard round housings and are available in three square flange styles with sharp edges for a contemporary appearance: round reflector, square 2" pinhole, and square 2.75" regressed opening. The trims include Cree-integrated LED modules with 650 lumens to 750 lumens and 92 CRI and high R9 values.

For more information visit tEDmag.com/InfoCard

23. LED PREMIUM HIGH-BAY

Columbia Lighting, a Hubbell Lighting brand offers its very high lumen package in its LLHP series of premium high-bay luminaires. Delivering 42,100 lumens at 425W, the LLHP3 VL replaces 1,000W metal halide HID high-bays at 60% energy savings while maintaining a compact size at 3' long by 1' wide. Providing efficacy of up to 99lm/W, the fixture has a long life of 60,000 hours at L90.

For more information visit tEDmag.com/InfoCard

24. LED POLE MOUNT

Lithonia Lighting's D-Series LED pole-mount fixture replaces 250W metal halide luminaires, providing energy savings and an expected service life of more than 20 years. The fixture utilizes existing drill patterns on a universal mounting plate for both round and square poles and is available with lumen packages up to 6,800 lumens (74W) and in a variety of color and control options.

For more information visit tEDmag.com/InfoCard

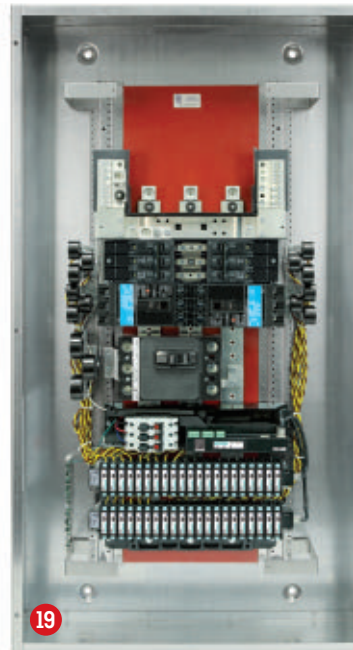



25. COLOR TEMPERATURE LEDS

Satco Products's Dimension LEDs not only darken as they dim, but also step down in color temperature from 2700K to 2200K, just as incandescent lamps do. Dimension lamps are available in 7.8W R20, 12.8W R30, and 16W R40 sizes and are Energy Star certified.

For more information visit tEDmag.com/InfoCard

26. STEEL SPLIT GROUNDING BUSHINGS

Bridgeport Fittings's Mighty-Rite steel split grounding bushings can be installed before or after pulling wire and making connections, making pulling wire easier than ever. More than just protecting conductors, the bushing's hinged design adjusts and aligns easier, even in tight spots, while self-aligning latches provide a simple, one-handed install.

For more information visit tEDmag.com/InfoCard

27. SHOE BOX LED RETROFIT

Light Efficient Design's LED-8090M (120W) and LED-8089M (80W) models are screw-in retrofit solutions suitable for horizontal socket applications common in parking lot lighting, walkways, and parks. These models replace 400W and 250W HID lamps, reducing energy use by over 65%. The 8090 and 8089 bases rotate to allow for perfect alignment, which is critical for LED directionality. Both models are UL1598c classified and UL listed for enclosed fixtures and damp locations.

For more information visit tEDmag.com/InfoCard

28. REMOTE CONTROL SOLUTION

Lutron Electronics's Caséta wireless and the Lutron Smart Bridge Pro and app together are a smart, connected home mobile solution. The wireless Smart Bridge and software application connect Lutron's Caséta wireless dimmers, Pico remote controls, Serena remote-controlled shades, and other third-party devices while providing convenient home control from any iOS or Android-based smartphone or tablet.

For more information visit tEDmag.com/InfoCard

29. LIQUIDTIGHT FLEXIBLE METALLIC CONDUIT

Southwire offers its re-engineered Titan2 liquidtight flexible metallic conduit. The conduit's higher-quality jacket reduces horse-collaring and increases durability, and its improved core increases flexibility while maintaining the strength required by the application. Titan2 is suitable for multiple applications—including conveyors; blowers; cranes; machine tooling; pool, spa, and hot tub motors; and hazardous locations.

For more information visit tEDmag.com/InfoCard

30. STEEL LIQUIDTIGHT FITTINGS

O-Z/Gedney's 4QS Steel Liquidtight fittings are available in trade sizes ranging from 3/8" to 4" in body designs of straight, 45°, and 90°. With a compact form factor for a tighter turning radius and a rugged design, the fittings can withstand the most abusive industrial environments. A captive gland stays in the connector, along with a hex-shaped gland nut and an extra-long hub that enables the use of bushings to protect conductors from abrasion. The reusable ferrule can be disassembled to save time and money in retrofit jobs.

For more information visit tEDmag.com/InfoCard



25



26



27



28



30

31. LED WALLPACK

Orbit Industries's slim-line LWP24 LED wallpack has a hinged compartment for easy installation and can be wall, trunion, or knuckle mounted. Available in 22W and 30W models and measuring 7.8" high x 4.29" deep, the wallpack features a cast aluminum housing and bronze finish. IP65, LM79, Cree LED, and DLC certified, it offers 50,000 hours of life.

For more information visit tEDmag.com/InfoCard



32. SURGE PROTECTIVE DEVICES

Intermatic's new surge protective device (SPD) includes three consumable modules utilizing TPMOV technology. Modules can be easily and safely replaced when protection is compromised, making for convenient DIY maintenance. Power and protection status LEDs alert the user when the consumable modules should be replaced. Designed for SPD Type-1 or Type-2 applications, the SPD is appropriate for residential and light commercial applications.

For more information visit tEDmag.com/InfoCard

33. FIBERGLASS FISH TAPES

IDEAL Industries's nonconductive S-class fiberglass fish tape is designed for use around energized sources. The flexible fiberglass core provides superior strength, greater pushing power, and smooth handling through multiple bends, and the durable, nonconductive eyelet offers added protection against arc-flash. Exceptional column strength, rapid tape payout and rewind, and a durable Tuff-Grip Pro case make this S-Class fish tape best in class for nonconductive applications, according to the company.

For more information visit tEDmag.com/InfoCard



34. LED LUMINAIRE FOR ROADWAYS

U.S. Architectural Lighting's Razar is an ultra-low-profile LED luminaire for roadways and public areas. Featuring a sleek, cutting-edge design, Razar complements contemporary architectural trends toward clean, minimalist lines. With an optical housing that is only 2½" deep, it reduces visual conflict with surrounding architecture.

For more information visit tEDmag.com/InfoCard



35. LED HIGH-BAY

DuraGuard Products's Bentley HB45Q LED high-bay is designed with integrated heat sinks and a separate driver and LED housings to provide superior thermal management. The specially designed 100% aluminum board maximizes optical performance, while the 22" array housing accepts clear or prismatic flat glass and acrylic conical or drop lenses. It provides 14,645 to 24,804 lumens and is available in 169W and 273W.

For more information visit tEDmag.com/InfoCard

36. AUDIBLE/VISUAL DEVICES

Federal Signal's StreamLine modular series is a line of audible/visual devices with a mix-and-match capability allowing users to create their own customized signaling solutions. Engineered to support multifunction signaling applications, the StreamLine series accommodates multiple channels and voltages and a full scope of mounting options and is CE compliant and UL and cUL listed.

For more information visit tEDmag.com/InfoCard





37. LINEAR FIXTURE

Litecontrol, a Hubbell Lighting brand's Liteweave Linear is designed to provide an unobtrusive solution for commercial, educational, and civic applications. With no visible frame or border, the Liteweave uses a precision-formed light diffuser to weave light across the visual plane, placing 80% down and 20% up for wide on-center spacing. The luminaire utilizes more than 200 low-brightness LEDs per foot, producing 4,300 nominal initial lumens with greater than 90% lumen maintenance at 80,000 hours.

For more information visit tEDmag.com/InfoCard

38. FLUSH-MOUNT LED FIXTURE

Satco Products's Energy Star-certified Blink 13.5W flush-mount LED fixtures have smooth dimming with constant light distribution and are edge lit to eliminate harsh glare and hot spots. Damp location listed and available in white or satin nickel finishes, the 1" model fits 4" junction boxes and the 1.8" "deep dish" models fit 4", 3", and pancake junction boxes.

For more information visit tEDmag.com/InfoCard

39. ADDS EMERGENCY LED LIGHTING CAPABILITY

Fulham's new field-installable, cULus-classified FireHorse HotSpot1 kits for troffers add emergency LED lighting capability to existing fluorescent fixtures by activating an LED module installed within the fixture during power outages. The 120V-277V system uses modular batteries to control run-time (90 to 360 minutes) and lumen output (500 to 1,250 lumens).

For more information visit tEDmag.com/InfoCard

40. LINE/LOW-VOLTAGE FLOOR BOX ASSEMBLIES

Allied Moulded Products offers a collection of line/low-voltage floor box assemblies for residential construction. Designed for use in wood floor construction, these assemblies are compatible with multiple floor substrate materials, including ceramic, hardwood, laminate, and carpet. Each floor box is UL listed; features tamper-resistant devices, extra-deep wiring capacity, and cover gaskets that provide a scrub watertight seal; and is available in round or rectangular profiles with brass, nickel, or dark bronze finishes.

For more information visit tEDmag.com/InfoCard

41. ADJUSTABLE FLOOR BOX

Arlington Industries's UL-listed, adjustable floor boxes are the low-cost, convenient way to put a receptacle in the floor. For new or retrofit work, they fit varying floor heights up to 2" for flush-to-the-floor receptacle installation. Oversized covers hide miscut flooring; gaskets prevent water intrusion; and threaded plugs or flip lids protect the box when not in use. Covers are available in nonmetallic (white, black, brown, or light almond) or metal (brass and nickel-plated brass) finishes.

For more information visit tEDmag.com/InfoCard

42. SOLAR-CHARGED LUMINAIRE

SEPCO's SolarUrban LED is a decorative luminaire complete with LEDs and a driver to operate from a furnished solar-charged battery. Available in three pole heights and dome sizes, the luminaire's LED white-light lamp outputs range from 15W to 60W and provide Type II, III, IV, and V dimmable distribution patterns.

For more information visit tEDmag.com/InfoCard

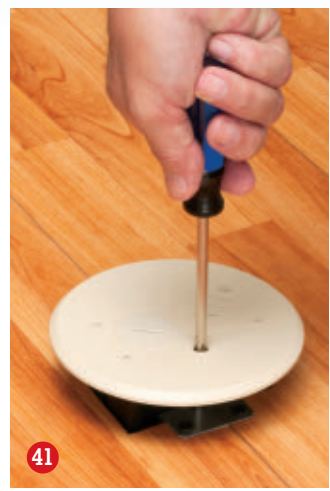
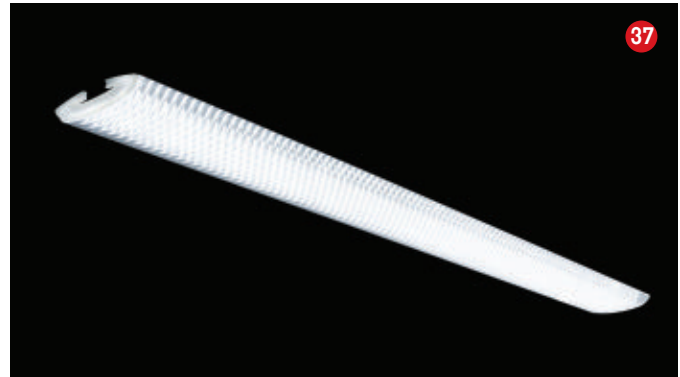

43. HYDRAULIC STUD PUNCH

Southwire Tools's Max Punch hydraulic stud punch is designed to quickly punch holes through 16-gauge structural steel studs. The multifaceted design allows the device to easily adjust for 3 $\frac{3}{8}$ " and 6" studs as well as punch $\frac{7}{8}$ " or 1 $\frac{1}{2}$ " holes.

For more information visit tEDmag.com/InfoCard

44. LED RETROFIT KIT

Terralux's DR88 LED retrofit kit allows for a quick upgrade of any 8" to 12" square pin-based CFL downlight using horizontally mounted lamps. The downlight uses half the power, delivers color quality above 80 CRI, and delivers a lifetime of more than 60,000 hours.

For more information visit tEDmag.com/InfoCard

45. HEAT TRACE CONNECTION KITS

Nelson's AX heat trace connection kits are engineered to meet the increased safety standards of the latest *NEC* hazardous location codes. Nonmetallic, impact-resistant polyester enclosures are rated *IP66* and *NEMA 4X*. Features include DIN-rail-mounted terminal blocks that help when maintaining the connection and spring-clamp terminals that simplify wiring. The kits fit all wattages of Nelson self-regulating heating cables (LT, HLT, QLT, and CLT).

For more information visit tEDmag.com/InfoCard

46. CABLE TESTER

IDEAL Networks's SignalTEK CT is designed to prove that copper cabling has been installed correctly and is capable of supporting GbE applications to the international standard *IEEE802.3ab*. SignalTEK carries out two primary tests via its autotest function: a wiremap test and a data transmission test. The wiremap test identifies and locates crossed pairs, opens, shorts, and split pairs using its TDR, while the data transmission test performs at 100Mbit/s or 1,000Mbit/s, providing 100% load on that link from both sides and offering users a clear reading if the link can support the desired Ethernet speed.

For more information visit tEDmag.com/InfoCard

47. UPLIGHT COMBINES DURABILITY & FUNCTION

Sollos Landscape Lighting's Bullet is a stylish uplight that combines durability and function. Its UV-resistant textured black and textured bronze finishes protect the fixture from corrosion while dual silicone O-rings and a gasketed knuckle assembly help prevent water intrusion. Light output is precise and simple to direct with the Bullet's adjustable knuckle.

For more information visit tEDmag.com/InfoCard

48. LOW-GLARE SOLUTION

Architectural Area Lighting, a Hubbell Lighting brand's Kick combines form and function on the pedestrian scale. As the industry's first product to angle upwards and yet provide full light cutoff, according to the company, the Kick's unique optical system delivers 12,880 lumens at up 99lm/W with 0% uplight and 0% backlight. The pole and luminaire are integrated into one angular design that delivers a low-glare solution for walkways, paths, and building entrances.

For more information visit tEDmag.com/InfoCard





49. ARCHITECTURAL LED WALLPACK

Topaz offers a complete line of LED outdoor lights featuring architectural styles appropriate for both new construction and replacement of existing HID fixtures. Featuring a half-moon housing design and delivering 2,845 lumens at 36W, the wallpacks are DLC qualified, provide up to 67,000 hours of useful life, and offer full-cutoff light distribution.

For more information visit tEDmag.com/InfoCard

50. MICRO PROFILE COVE

Finelite Series 11 LED Micro Profile Cove achieves a custom-ordered fit without the wait time using an optional 12" telescoping light engine. Available in run lengths of 2', 3', 4', and 8' (and multiples), the fixture features high and standard output lumen packages at 3000K, 3500K, and 4000K; standard dimming; and a replaceable LED light array.

For more information visit tEDmag.com/InfoCard

51. ALTERNATIVE TO SPOOLS

Southwire's SIMpull CoilPAK Mini wire payoff eliminates the need for 500' spools by providing the circuit wire in an ergonomically designed, easy-to-handle package that weighs approximately 25 lbs. Available in solid or stranded and single or multiple wire packages, it includes NoLube SIMpull THHN wire and provides an easier-to-transport alternative to bulky spools that helps to reduce potential injuries associated with heavy lifting.

For more information visit tEDmag.com/InfoCard

52. LINEAR LUMINAIRE

Appleton's Viamaster LED linear luminaire delivers clean, high-lumen lighting in industrial areas classified as Class I, Div. 2 by the NEC and Zone 2 by the IEC, such as onshore and offshore petrochemical operations, chemical processing plants, mining, wastewater treatment centers, and pulp and paper manufacturing. Rated IP66 and NEMA 4X, the Viamaster can also be used with confidence in marinas or washdown areas.

For more information visit tEDmag.com/InfoCard

53. GROUNDING CONNECTOR

BURNDY offers the Super-Clamp, a multifunctional, easy-to-install, range-taking grounding connector for connecting cables in parallel or cross-configurations. It is cULus listed for use with rebar sizes #7 to #12 ($\frac{3}{8}$ " to 1 $\frac{1}{2}$ " diameter), can accept one or two wires of wire range #6 solid to 4/0 stranded, and can be used on round or square pedestals (round: $\frac{3}{8}$ " to 2"; square: $\frac{3}{8}$ " to 1 $\frac{1}{2}$ ") in the parallel or cross-grid patterns. Super-Clamp is used in the petrochemical, utility, and transportation industries; wind energy projects; industrial construction; and any project where rebar needs to be grounded.

For more information visit tEDmag.com/InfoCard

54. LOW-SMOKE ZERO-HALOGEN CABLE

General Cable's Stabiloy low-smoke zero-halogen cable is engineered to deliver safety and performance benefits of superior flame resistance, low smoke emission, and zero halogens. The cable is rated at 90°C wet or dry, is UV/sunlight resistant, meets cold bend and cold impact tests at -40°C, and features a low-friction jacket for easy pulling on 6AWG and larger.

For more information visit tEDmag.com/InfoCard



55. ALL-IN-ONE DOWNLIGHT FIXTURE

Prescolite, a Hubbell Lighting brand's LBSLEDA is an all-in-one LED commercial downlight fixture built to fit a standard 4x4 J-box that features an intuitive snap-in system for easy flush-mount installation. Whether a commercial, new construction, remodel, or residential project, the LBSLEDA is an energy-efficient alternative to recessed products in settings where plenum height is challenging or fire codes restrict the use of recessed fixtures. **For more information visit tEDmag.com/InfoCard**

56. DOME CAMERA

LILIN's CMD2422 Series HD two-megapixel dome camera offers 360° coverage in 1,600x1,200 pixel HD resolution that accurately monitors up to 4,000 square feet, providing four independent views from one camera that reduces the amount of cameras and cabling needed. Other features include an IR cut filter for true day/night imaging, RS-485 control interface, IP66 outdoor rating, and on-screen display setup for faster installation. **For more information visit tEDmag.com/InfoCard**

57. 12V LED RECESSED RETROFITS

Satco Products's 12V LED recessed retrofits offer an energy-saving upgrade for existing halogen MR16 systems up to 50W. The 7W, 3" baffle model is wet location listed and delivers 400 lumens; the 7W, 3", 30° directional gimbal model is damp location listed at 430 lumens; and the 8W 4" baffle version is wet location listed at 460 lumens. The retrofits are dimmable, work with magnetic and electronic 12V transformers, and include a bipin adapter. **For more information visit tEDmag.com/InfoCard**

58. ANTIMICROBIAL WIRING DEVICES

Ericson Manufacturing's Perma-Kleen antimicrobial wiring devices control microbial growth by incorporating antimicrobial additives that remain stored in the polymer, providing continual, long-lasting protection. The embedded additives resist high-pressure hose-down and continue to inhibit the growth of bacteria, mold, mildew, and fungi—even when nicked or scraped. **For more information visit tEDmag.com/InfoCard**

59. WIRELESS CONTROL DEVICES

Sensor Switch's wireless occupancy sensors provide passive infrared (PIR) and PIR/Microphonics dual-technology detection options. The battery-powered sensors use RDT wireless technology and are designed to work with the SPODMR WR series wall switch/load controller or other RDT wireless control devices. With no need to wire directly to the sensor, single-room applications like offices and restrooms can easily be converted. **For more information visit tEDmag.com/InfoCard**

60. FLUORESCENT EMERGENCY BALLAST

Philips Emergency Lighting's Bodine B30HV fluorescent emergency ballast transforms high-voltage high-bay fixtures into code-compliant emergency lighting sources. The B30HV is a 347V to 480V (50/60Hz) model and is compatible with T5HO lamps. UL listed and CSA certified, the B30HV provides 1,100 to 3,500 lumens, operates 90 minutes in emergency mode, and is suitable for large warehouse 480V high-bay applications. **For more information visit tEDmag.com/InfoCard**





61. SLIP EMT CONNECTORS

Bridgeport Fittings's Mighty-Align DC2SLP Series slip EMT connectors are used to connect EMT between mounted enclosures or equipment. Designed for limited-space applications, the cETLus-listed solution saves time by preventing short conduit cuts: Contractors simply measure between enclosures for proper conduit installation.

For more information visit tEDmag.com/InfoCard

62. SPECIAL PACKAGING FOR FIRE ALARM CABLE

Honeywell Genesis Series Cable's REACT packaging for Genesis Series fire alarm cable eliminates tangles, saving time, money, and hassle. The patent-pending reactive brake system feeds cable when installers want it and stops automatically when they don't. The packaging has reinforced sidewall design/handles for durability, is easy to stack and carry, and is 100% recyclable.

For more information visit tEDmag.com/InfoCard

63. SNAP-IN CONNECTORS

Arlington Industries's new 90° Snap2It snap-in connectors are easy to install and save about one minute per connector over two-screw 90° styles by eliminating several installation steps but at the same cost per connector. The connectors also handle the widest variety of 14/3 to 10/3 cables: AC, MC, HCF, MC continuous corrugated aluminum cable, MCHA cables (steel and aluminum), AC90, and ACG90.

For more information visit tEDmag.com/InfoCard

64. AIR-SEALED ELECTRICAL WALL/CEILING BOXES

Allied Moulded Products's full line of patented vapor seal electrical boxes provide a solution to builders working in a range of housing situations, from single-family homes to multifamily residential construction. The boxes prevent air infiltration on walls/ceilings where holes for electrical devices and ceiling boxes are required, and the unique fire-resistant fiberglass materials allow for reduced box separation in the same stud cavity of fire-rated walls.

For more information visit tEDmag.com/InfoCard

65. LED PLC LAMPS

Kobi Electric's PLC LED lamps are a retrofit for the most popular pin-based 13W, 18W, and 26W CFL lamps. The bulbs have a pin base that fits G24 four-pin and two-pin diagonal CFL sockets, operate without a ballast, and are available in various color temperatures (2700, 4100, and 5000K) and wattages (9W, 12W, and 16W).

For more information visit tEDmag.com/InfoCard

66. OPTIMAL LIGHT UNIFORMITY

Eaton's Cooper Lighting Business's Metalux Cruze LED Series combines advanced LED technology with a fully luminous sleek and clean center lens profile to generate optimal light uniformity and enhanced visual comfort. It is offered in 2x2' and 2x4' configurations, three color temperatures, and multiple lumen packages with 0-10V dimming standard. A hinged door offers toolless entry from below-ceiling access and an integral sensor option offers additional energy savings.

For more information visit tEDmag.com/InfoCard

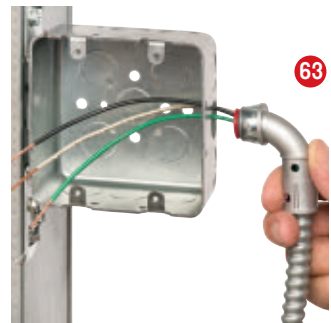

67. GAS DETECTORS

Macurco's 12-Series line-voltage-powered (100-240VAC, 50-60Hz), dual-relay gas detectors and controllers have an on-board 5A relay to control valves, louvers, or exhaust fans and a 0.5A relay to initiate warning devices or control panels. These stand-alone detectors can monitor various gases and provide automatic control to reduce gas concentrations in attics, crawl spaces, boiler rooms, commercial kitchens, parking garages, vehicle maintenance facilities, and other applications.

For more information visit tEDmag.com/InfoCard

68. LED DOWNLIGHT

Progress Lighting's P8022 is a surface-mount LED downlight with light output and distribution that rivals that of a typical 65W BR30 incandescent but at only 12W of power. Ideal for new construction and remodel and single- and multifamily applications, the P8022 is available in both warm white 2700K (incandescent) and 3500K halogen and is dimmable for use with most three-wire low-voltage electronic dimmer switches.

For more information visit tEDmag.com/InfoCard

69. LINEAR LED LUMINAIRE

Topaz offers a compact, stylish linear LED luminaire that delivers 4,400 lumens at an exceptional efficiency of 120lm/W. The fixture is DLC qualified and is suited for commercial applications including classroom, supermarket, and office. This 4' luminaire is available in 4000K and 5000K, can be surface mounted or suspended, and is equipped for (0-10V) dimming.

For more information visit tEDmag.com/InfoCard

70. LED HIGH-BAY/LOW-BAY

Cree's CXB Series LED high-bay/low-bay luminaire delivers 18,000 median and 24,000 median lumens to allow one-for-one replacement of 250W and 400W HID luminaires and multilamp fluorescent fixtures. With exceptional rated lifetimes, the CXB Series is offered with reflector choices of aluminum and clear and white acrylic with optional bottom lenses, making it a good choice for a variety of applications.

For more information visit tEDmag.com/InfoCard

71. VAPOR-TIGHT FIXTURE

Shat-R-Shield's LED Vapor Tight fixture's small, lightweight form factor (weighing less than 5 lbs.) is composed of corrosion-resistant thermoplastics ideal for exposure to harsh environments. The fixture is available in 35W/3,500 lumens/5000K and 70W/7,000 lumens/5000K and is DLC, NSF, and IP66 rated.

For more information visit tEDmag.com/InfoCard

72. SUSPENDED LUMINAIRE

Eaton's Cooper Lighting business's Corelite RZL suspended luminaire combines exceptional lumens-per-watt performance with a slim modern design. The proprietary LED platform delivers a soft, diffuse volume of pure white light both on task and ambient surfaces, and an expansive selection of lensing and baffle options offers different distributions and aesthetics to meet a wide range of applications—including supermarkets, open offices, and educational facilities.

For more information visit tEDmag.com/InfoCard





PRODUCT PREVIEW | 2015

73. HD PAR LAMPS

Sylvania offers the Ultra Pro and Ultra Pro HD PAR LED lamps, available in 7W PAR20, 10W PAR30, 13W PAR30LN, and 17W PAR38. Dimmable to 5% and delivering up to 86% energy savings, the lamps are available in 2700K, 3000K, 3500K, and 4000K CCT and either standard 82 CRI or 92 CRI for color-critical applications with rich deep red content (R9>50), ideal for retail and museum accent lighting and healthcare and warm hospitality settings. Beam angles range from spot (12°) to flood (40°).

For more information visit tEDmag.com/InfoCard



74. LED FLOODLIGHT

Eaton's Cooper Lighting business's Lumark Night Falcon LED floodlight luminaire combines high-efficiency optics, superior thermal management, and energy efficiency in a cost-effective solution for illumination to targeted applications. The design incorporates a separate driver compartment for maximum heat dissipation, ensuring longevity of the fixture and the optics.

For more information visit tEDmag.com/InfoCard

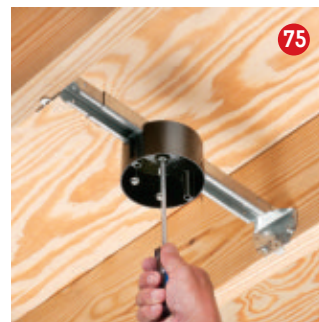

75. FAN/FIXTURE BOX

Arlington Industries's UL-/CSA-listed FBR423 fan/fixture box is a solution for secure mounting in new construction. Its fully adjustable steel bracket installs between joists spaced 16" to 24", and the bracket ends are set for flush installation on a 1/2" ceiling but are bendable along score lines for ceiling depths up to 1 1/4" thick. Additionally, the plastic box is positionable anywhere along the bracket.

For more information visit tEDmag.com/InfoCard

76. SNAP-IN/SET SCREW TRANSITION COUPLING

Bridgeport Fittings offers the Mighty-Merge Snap-in/Set Screw transition coupling—one fitting that does the work of three, according to the company. The coupling features a set screw end for EMT and a quick install snap-in end for AC/MC cables and flexible metal conduit. It is ideal for transitioning fixture whips above a drop ceiling and continuing the speed of MC down the wall to emergency lights.

For more information visit tEDmag.com/InfoCard



77. PORTABLE GFCI

Tower Manufacturing offers a 120-volt, 20A-rated panel-mount GFCI with features that include a nominal 4-6mA trip level, 12-gauge line and load-side stranded leads, and an LED power-on indicator light. The GFCI can be installed in enclosed control boxes, industrial electrical panels and bulkheads, and temporary power (spider) boxes and with pumping controls for spas and pools. Mounting hardware is included.

For more information visit tEDmag.com/InfoCard



78. CRIMPING & STRIPPING DEVICE

Phoenix Contact's Crimphandy is a portable device powered by a lithium-ion battery that enables users to strip and crimp wires in two seconds and includes monitoring LEDs and a wire-size-check to provide operating status information and prevent improper crimps. Similar in size to an electric screwdriver, it is the smallest battery-operated, handheld stripping and crimping device available on the market, according to the company.

For more information visit tEDmag.com/InfoCard

79. SURFACE-MOUNT LED LUMINAIRE

Eaton's Cooper Lighting business's Portfolio LSM/LSWM series surface-mount LED luminaire uses WaveStream LED technology to provide outstanding optical performance and glare control. Offering packages from 4,500 to 9,000 lumens, the luminaire delivers up to 100lm/W; is available in 2700K, 3000K, 3500K, and 4000K and 80 or 90 CRI; and can be ceiling, wall, or pendant mounted or hung by aircraft cables, making it a good choice for standard and high-ceiling applications.

For more information visit tEDmag.com/InfoCard

80. LED DOWNLIGHT FIXTURE

Terralux offers the DLSQ8 LED downlight fixture, an efficient, comfortable alternative to a 2x42W CFL architectural square fixture. The downlight uses less than half the power for the same light, delivers 80+ CRI, and provides more than 60,000 hours of life.

For more information visit tEDmag.com/InfoCard

81. BATTERY-ACTUATED CRIMPING TOOL

BURNDY's PATRIOT PAT46LW 15-ton battery-actuated crimping tool features a forged latching head that offers a weight reduction of 34% over its previous design. The tool accepts all BURNDY standard "P"- and "U"-style crimping dies (w/PUADP-1 adapter) and offers the choice of ordering the tool kits with 18V Makita lithium-ion batteries, with 18V Makita nickel metal hydride batteries, or without the batteries and charger.

For more information visit tEDmag.com/InfoCard

82. PANEL LIGHT FIXTURES

Halco Lighting Technologies's ProLED panel light fixtures feature a direct backlit design that provides uniform light distribution not found in edge-lit panels. The fixtures are DLC qualified; are available in 1x4, 2x2, and 2x4 sizes and 3500K, 4000K, and 5000K color temperatures in both traditional and volumetric designs; and operate on 0-10V dimming standard.

For more information visit tEDmag.com/InfoCard

83. 3" SQUARE INSTALL FROM BELOW

Kurt Versen, a Hubbell Lighting brand's 3" square install from below LED product family provides the aesthetic appeal of an architectural-grade lighting fixture to an existing ceiling or where installation from below is required. The optical system provides glare and brightness control for each downlight and is offered in 1,100 and 1,500 lumen packages with 3000K and 83 CRI standard.

For more information visit tEDmag.com/InfoCard

84. OUTDOOR LIGHTING SOLUTION

MaxLite's LED bullet floodlights provide directional lighting for landscape, façade, and outdoor signage. Sealed to keep out dirt, insects, and moisture, the floodlight is constructed with a precision diecast aluminum housing and tempered, shatter-resistant glass. Replacing up to a 150W metal halide, it is offered in 5000K and 3000K (all in NEMA 5x5 field distributions), can be surface mounted directly to electrical boxes or posts, and features a locking swivel arm for angle adjustment.

For more information visit tEDmag.com/InfoCard





Index

AFC Cable Systems	70	Litecontrol, a Hubbell Lighting brand	76
Allied Moulded Products	76, 80	Lithonia Lighting	73
Appleton	78	Lutron Electronics	70, 71, 74
Architectural Area Lighting, a Hubbell Lighting brand	77	Macurco	81
Arlington Industries	70, 76, 80, 82	MaxLite	83
Bridgeport Fittings	74, 80, 82	Nelson	77
BURNDY	78, 83	Nora Lighting	73
Columbia Lighting, a Hubbell Lighting brand	73	NSi Industries	71
Cree	81	O-Z/Gedney	74
DuraGuard Products	75	Orbit Industries	72, 75
Eaton's Cooper Lighting business	70, 80, 81, 82, 83	Philips Emergency Lighting	79
Engineered Products Company	72	Phoenix Contact	82
Ericson Manufacturing	79	Prescolite, a Hubbell Lighting brand	79
Federal Signal	75	Progress Lighting	81
Finelite	78	Satco Products	74, 76, 79
FLIR Systems	70	Sensor Switch	79
Fulham	76	SEPCO	76
General Cable	78	Shat-R-Shield	81
Halco Lighting Technologies	83	Siemens	70, 72, 73
Honeywell Genesis Series Cable	80	SolaHD	71
IDEAL Industries	72, 75	Sollos Landscape Lighting	77
IDEAL Networks	77	Southwire	74, 78
Intermatic	75	Southwire Tools	73, 77
Klein Tools	72	Sylvania	82
KNIPEX	71	Terralux	71, 77, 83
Kobi Electric	80	Thomas & Betts	73
Kurt Versen, a Hubbell Lighting brand	83	Topaz	78, 81
Leviton Manufacturing	71	Toshiba	72
Light Efficient Design	74	Tower Manufacturing	82
LILIN	79	U.S. Architectural Lighting	75



2015 NAED South Central Region Conference

February 17-19 | JW Marriott Hill Country | San Antonio, Texas

Paul DePodesta, subject of the film "Moneyball," will discuss the innovative strategies he used to create a winning team and how to apply these strategies in the corporate world.



NATIONAL ASSOCIATION OF
ELECTRICAL DISTRIBUTORS

naed.org/southcentralregionconference

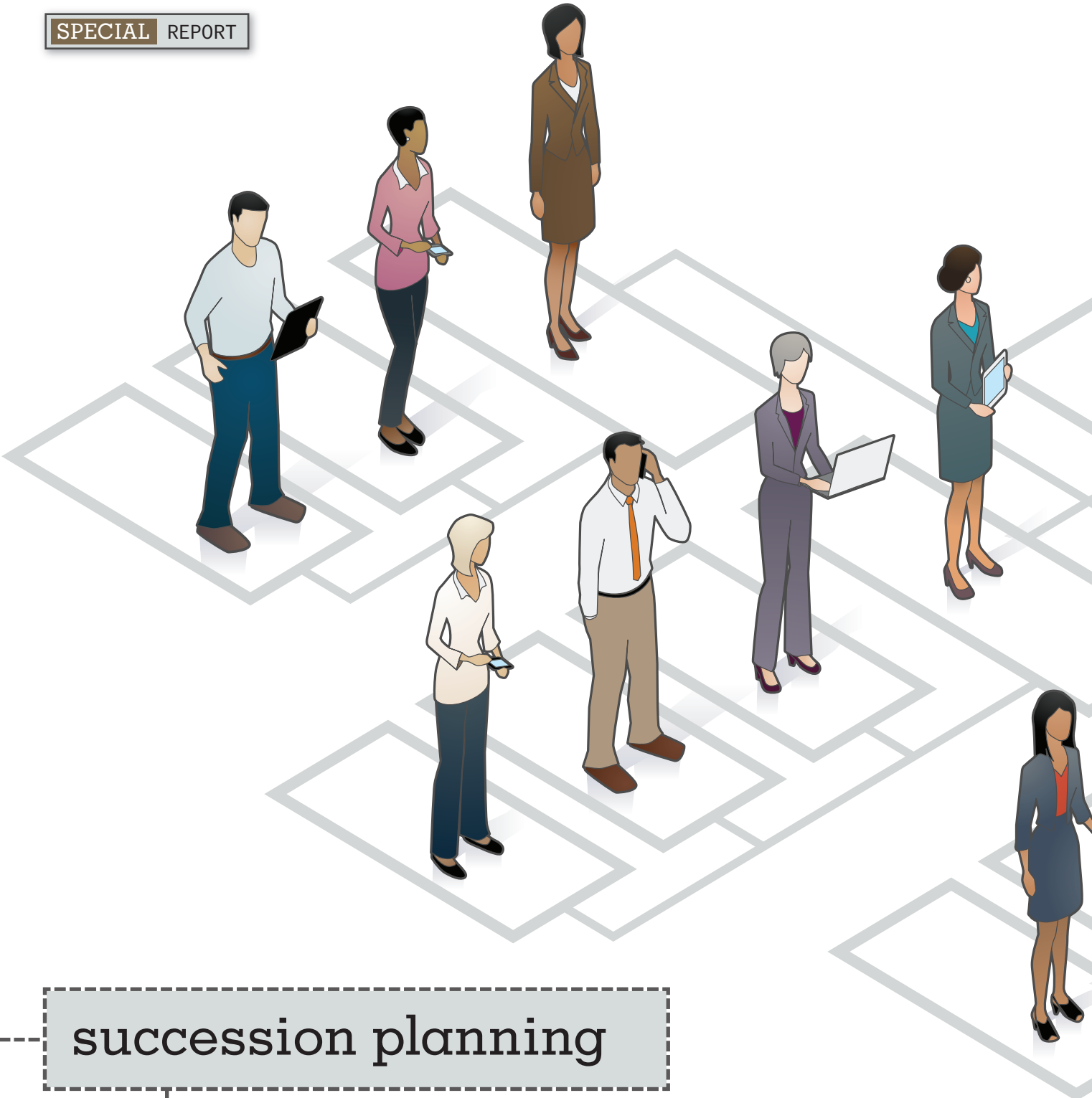

succession planning

TAKES TALENT

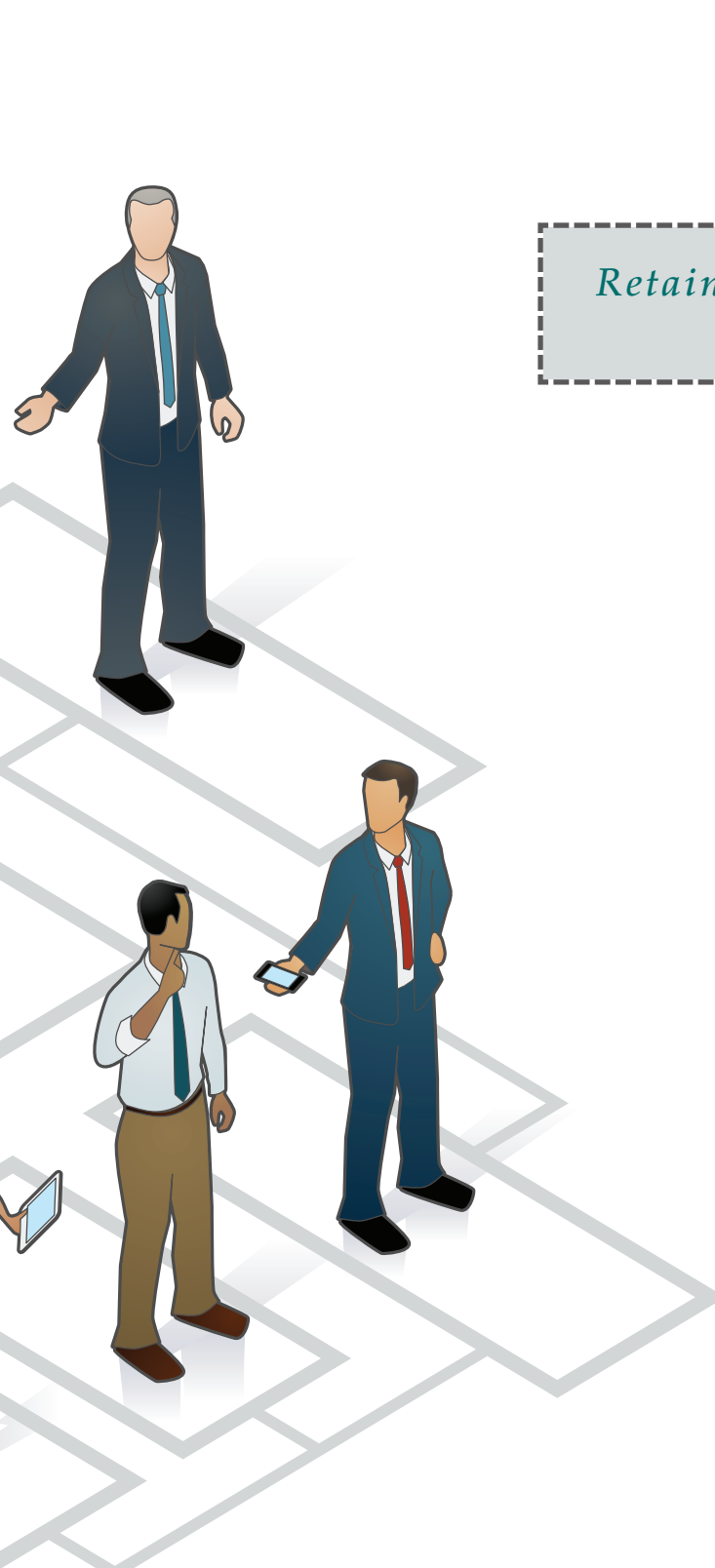

Retaining your best and brightest is key to a successful succession plan.

BY LISA ANDERSON

According to a survey performed by the LMA Consulting Group (lma-consultinggroup.com) in conjunction with the APICS Inland Empire Chapter (apics-ie.org), executives said that succession planning is tied as a No. 1 priority in retaining top talent. This is especially noteworthy when considering that 87% of manufacturers and distributors are experiencing a skills gap—that is, their employees do not have enough skills to meet the ever-increasing requirements or they have lost qualified people to retirement, job transfers, etc. Yet 77% of manufacturers and distributors are struggling to find qualified candidates. In short, an employer's ability to retain scarce top talent is considered essential.

Since succession planning is core not only to retention, but also to having a proactive approach to organizational planning for long-term sustainability, it must become a priority. As noted in the research comments, developing succession planning programs with the opportunity for employees to develop the skills, behaviors, and experiences required to be successful in the postrecession era is critical.

Since businesses have become increasingly complex and customers' expectations are elevated, employers must be prepared and adept at how to navigate myriad operational complexities while managing risk and handling increased regulations and requirements. Key elements of succession planning include:

- **Performance management.** A critical area of focus should start with the often-overlooked fundamental:

performance management.

Employees should never hear new feedback during the yearly performance review process. Instead, managers and employees should meet quarterly to review progress in the prior quarter and to discuss the top priorities for the next quarter. Through the process of reviewing goals and focusing on just the essential few, managers and employees gain alignment and clarity.

Once goals are agreed upon, frequent interaction needs to remain a priority. Immediate and specific positive and corrective feedback must occur. Managers often shy away from addressing problems up front because of fears that it will be uncomfortable and create unhappy employees, but, in fact, the opposite occurs: Employees respect the rare manager who will confront reality in a constructive manner.

© MATHISWORKS/ISTOCK

Transition: the blind spot for many business owners

Blood, sweat, and tears; late nights and weekends spent working; sacrificed vacations and family time—indeed, a CEO's feelings toward his or her business often mirror those that a parent has for a child.

Unfortunately, when it comes time to take the next step in life, the gravity of letting his or her baby go can prove overwhelming.

“Successful business owners tend to pore over every detail to improve the venture, but what they often overlook is the fact that, like parents to a child, they will someday have to allow that baby to move on,” said Jane Johnson, co-author with Kathleen Richardson-Mauro of a practical new guide, *Cashing Out of Your Business*, and complementary website of self-help resources, Business Transition Academy (businesstransitionacademy.com).

“As business owners, we've both experienced difficult transitions professionally and personally,” Richardson-Mauro said. “So many CEOs, rather than dealing with the reality of their businesses' future without them, carry on as if nothing will change.”

Richardson-Mauro and Johnson say there are a number of measures owners can take to ensure the transition is smooth and they have what they need to be happy on the other side of it:

- **Change is natural; learn to accept it with regard to your business.** If you're like most owners, you have invested some or most of the best years of your life—and most of your financial resources—in your business. By now, your identity and that of the business may actually be one and the same. But now is the time to focus on your other passions, which may be family, traveling, catching up on reading, fitness, etc. Consider your next act as your rebirth.

- **Learn to count beans—outside of your business.** Now is the time to take stock of the assets you've saved outside of the business and determine how much income you'll need posttransition. Then, calculate how much money you'll need to receive from the ownership transition. Be realistic about how you want your money to be spent in the next phase.

- **Is your business transitioning “in-house”?** Small businesses—those with fewer than 500 employees—are responsible for nearly half of the GDP and employment in the United States, and many of these are family-run enterprises. Naturally, owners often want to keep it in the family, which doesn't always work out. Attempts to be “fair” can cause businesses to crumble. Instead, be honest about what will actually be good for the business and its employees. —tED

Business conditions also change, even within a quarter. Therefore, goals must be flexible enough to fit within the company's changing strategies and objectives, but it is essential that both parties remain on the same page. Conversations should occur about how the goals and resulting achievements contribute value to the company and to the employee's career progression.

- **Rating and ranking systems.** Another critical priority in succession planning is to have a rating and ranking system so that executives know who to develop, fast track, and sustain. These types of systems identify star performers with high potential for certain career paths. Thus, while succession planning programs support the entire organization, they focus special attention on high-potential employees.

- **Development opportunities.** Providing opportunities for training, mentoring, and developmental experiences is integral to achieving succession planning objectives. Ideally, executives should implement formal mentoring programs; however, at a minimum, they should provide guidelines and opportunities for mentoring to occur. A mentor is someone who has “been there, done that.” His or her experience can be invaluable to succession planning and retention as it affords the employee the chance to learn from an expert and be provided opportunities to test new ideas, leadership styles, and the like.

Planning for training opportunities is also critical to

succession planning success. It is not as simple as offering a class or paying for a class. The key is for the manager to be involved in implementing a backup to support the function while the employee is in training and to provide opportunities for the employee to apply immediately the skills learned.

Executives need to think about the types of experiences required for succession planning. For example, for a high-potential employee to be ready to take over as a general manager of a facility or division, it is likely important that he or she obtain cross-functional experience. No matter how effective the employee is at his or her current job, succession planning dictates that opportunities will be provided.

- **Leadership.** The success or failure of succession planning initiatives will boil down to leadership: Leaders must show up.

In today's information-overloaded society, leaders rarely have time to dedicate to employees—but they need to remember that where they spend their time communicates their priorities much louder than what they say. When making sure the company has the bench strength to thrive, leaders need to think of time as a priority, not as a limited resource. ■

Anderson, president of the LMA Consulting Group (lma-consultinggroup.com), is a senior supply chain and operations executive and management consultant. Reach her at landerson@lma-consultinggroup.com.

Join the NAED Electrical Industry Band

Step into the spotlight at the NAED National Meeting.

Be a part of the National Meeting Closing Ceremony by auditioning for the NAED Electrical Industry Band. This band will be the main entertainment at the Closing Ceremony in Chicago on May 18.

We have several openings for both singers and musicians. Submit your audition video no later than February 11, 2015.

Visit naed.org/NationalBand for complete details.

naed.org/nationalband

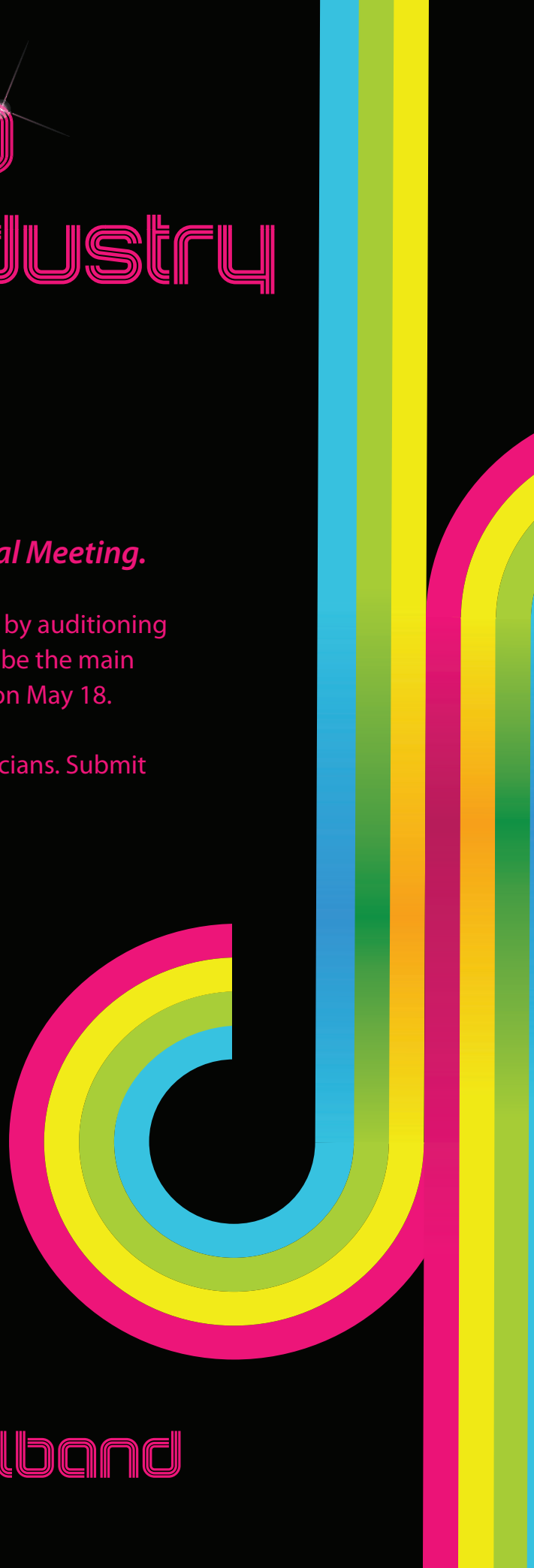



family business

succession planning

A DIFFERENT TAKE

BY HOWARD COLEMAN

According to a recent study by MCA Associates, 60% of family-owned businesses do not have a full and active succession plan—and about 50% haven't even thought about a choice of successor. These owners are in danger of having worked all their lives creating, building, and running a business only to have it fall into limbo when the time comes for their retirement or upon their untimely death or disablement.

Succession is a once-in-a-lifetime event, often fraught with emotional and financial issues that are stressful to not only the family, but also the family business, which is a good reason to look at succession planning as a process rather than a singular event.

There are many reasons companies don't have (or fail at) a succession plan—including a fear of discussing the future beyond the lifetimes of the owners, a fear of letting go and/or loss of meaningful life, difficulty in

making hard choices, feelings of entitlement among potential successors, and even spousal influences.

Adding to the confusion are the many choices available when it comes time for the current management team to hang up the reins: sell to an outsider or employee, hire someone from the outside to run the business, retain family ownership and management control, or do nothing or minimal due diligence and leave chaos behind.

When owners do get around to creating a succession plan, the initial conversation almost always turns to the financial considerations. And while these are surely not unimportant issues, the problem is that many owners shy away from the sometimes-difficult issues related to who the successor(s) will be. They fool themselves into believing that choosing the right successor is a slam dunk, particularly if it is someone in the family. They lose sight of the fact that the definition of succession planning is really made up of two distinct parts—a science and an art:

- A transfer of assets to a successor or successors (the science)
- A transfer of control to those best suited to exercise it (the art)

THE FOUR PHASES OF A SUCCESSION PLAN

Most succession plan advisors agree that if plans are made early enough, the four phases to a successful succession plan are:

1. Initiation: Children, or others, begin to learn about the business and make decisions about coming into it.

2. Education: Potential successors are trained and a path to growth and responsibility is provided.

3. Selection: The successor(s) and the company's leader(s) in the next generation are chosen.

4. Transition: The timely, orderly, and final transfer of control to a successor is begun, which may also include the role, if any, of the current owner.

The selection phase is the most important—and some-

times may not be as obvious as one thinks, which is why I choose to redefine the definition of succession planning as “a purposeful initiative focused on leadership talent,” regardless of whether the transition is to a family member or outside management or just to build bench strength.

The critical competency in this selection phase is leadership competency, so one can’t ignore the three factors of knowledge, skills, and personal attributes (KSPs). The combination of these three factors offers clarity about the core competencies that should exist in an individual (a potential successor) and identifies the gaps that may exist:

- **Knowledge:** the sum of an individual’s experiences and what he or she knows as it relates to the business, across sales, operations, finance, IT, etc.

- **Skills:** how a person can apply what he or she knows in a productive way

- **Personal attributes:** leadership and behavioral styles, emotional intelligence, attitudes—i.e., the personal skills required of leadership

Personal attributes can be a limiting factor. Where knowledge and skills can be learned or taught, personal attributes are effectively who we are.

As part of the selection phase, benchmark the specific criteria, such as those that follow, and the degree to which one must possess these attributes:

- Motivation, drive, and competitiveness—e.g., drive to succeed, innovation, and out-of-the-box thinking

- Results and goal orientation (as opposed to just performing tasks)

- Interpersonal skills

- Communication and persuasiveness (the ability to influence others is a major personal attribute)

- Emotional intelligence—i.e., the ability to facilitate high levels of collaboration and productivity

DON'T GO IT ALONE

When it comes to succession planning, there is no reason to go it alone. Obtain a family business analysis by working with a consultant, an advisor, etc., knowledgeable about succession planning, who understands the emotions and broader implications of change involved and who can help facilitate the succession planning and implementation issues.

Additionally, use one of the many assessment tools that exist in the marketplace today that can help evaluate succession candidates’ skills, aptitudes, and behavioral traits as well as work-related leadership characteristics and how they will “click” at the top of the organization—even if, for now, it is from a personal development point of view.

After all, succession planning and choosing the right successor is really about job suitability—isn’t it? ■

Coleman is principal of MCA Associates (mcaassociates.com), a management consulting firm that works with wholesale distribution and manufacturing companies that are seeking and committed to operational excellence. He can be reached at 203-732-0603.

Transitioning from CEO to retiree: Three steps to take now

Today’s 50-something CEOs tend to have vague dreams of more fishing, traveling, or sailing when they retire, but they don’t know when that might be so they haven’t begun planning for it.

That’s a mistake, say a trio of specialists: wealth management advisor Haitham “Hutch” Ashoo, CEO of Pillar Wealth Management (pillarwm.com); Jim Kohles, chairman of RINA accountancy corporation (rina.com); and John Hartog of Hartog & Baer Trust and Estate Law (hartogbaer.com). The trio offer these suggestions and considerations from their respective areas of expertise:

1. Identify specific lifestyle goals for retirement so you can plan for funding them. Each goal will have a dollar amount attached. You (or your advisor) can then determine whether it’s feasible and, if so, put together a financial plan.

“But you can’t just create a plan and forget it. Monitor its progress regularly and make adjustments to ensure you’re staying on course, just like you would if you were sailing or flying,” Ashoo said.

2. Don’t sell yourself short when selling your business. “If you’re banking on money from the sale of your business, know that it’s unlikely you’ll have investors just waiting with the cash for the chance to buy it when you’re ready to sell,” Kohles said.

Buyers are more likely to offer to pay over time from the company’s future earnings—which leaves the retired CEO with no control over the business and utterly reliant on the new owners to maintain its profitability. A good alternative is to establish an S corporation combined with an employee stock ownership plan (ESOP), Kohles advised.

3. What do you want your kids’ inheritance to say? If you have children, this decision can change their lives for the better—or worse.

“How your assets are disposed of should reflect your values. A lot of people prefer to think in terms of taxes at the expense of values, but I advise against that,” noted Hartog, adding that, for children, incentive trusts can encourage, or discourage, certain behaviors. “If you’re concerned your adult child won’t be productive if he or she has a lot of money, set up a trust that will make distributions equal to what the child earns himself or herself. Or, if you want to be supportive of a child who’s doing something socially responsible, like teaching in an impoverished area, you can set it up to pay twice his or her salary.”

There are many creative ways to establish trusts, Hartog added. Plan about five years out and change the trust as life events dictate. —tED

advertisers' index

To request free information on the products and/or services offered by *tED* advertisers, visit tEDmag.com/InfoCard.

ADVERTISER	WEBSITE	★★★	PAGE
		PRODUCT TRAINING AVAILABLE AT NAED.ORG/NLC	
Arlington Industries	aifittings.com	✓	11, 49, 93
Atlas Lighting Products	atlasled.com		38, 39
Bridgeport Fittings	bptfittings.com	✓	IBC
BURNDY	burndy.com	✓	IBC
DuraGuard Products	duraguard.com/EasyLED		3
Electrical League of Ohio	electroexpo.org		59
Federal Signal Industrial Systems	federalsignal-indust.com		29
FIRST	usfirst.org		51
FLIR Commercial Systems	flir.com/tg165/electrical	✓	43
General Cable	generalcable.com		9
Hammond Manufacturing	hammondmfg.com	✓	25
IDEA	idea4industry.com		40
Intermatic	intermatic.com	✓	7
Legrand/Pass & Seymour	legrand.us/night-light-dist	✓	23
Legrand/Wiremold	legrand.us/overfloor	✓	22
Leviton Manufacturing	leviton.com/values	✓	21, 65
Light Efficient Design	led-llc.com		27
Lutron Electronics	lutron.com/sensors	✓	5
MaxLite	maxlite.com		37
NAED/Branch Management University	naed.org/enroll		46
NAED/EPEC	naed.org/epec		63
NAED/Happy Holidays	naed.org		95
NAED/National Meeting Band Auditions	naed.org/nationalband		89
NAED/South Central Region Conference	naed.org/southcentralregionconference		85
NSi Industries	nsiindustries.com	✓	19, 57
Orbit Industries	orbitelectric.com		31
SATCO Lighting	satco.com		61
Siemens Industry	usa.siemens.com/dualfunction	✓	33
Southwire	southwire.com	✓	1, BC
tED magazine/tEDmag.com	tedmag.com		54
tED magazine/tEDTV	tedtv.tedmag.com		12
Topaz	topaz-usa.com		15, 17

TED (ISSN 1067-3806) is published monthly by the National Association of Electrical Distributors, Inc., for the information of its members and those manufacturers interested in selling through the electrical distributor. Publication office: 1181 Corporate Lake Drive, St. Louis, MO 63132. Phone (314) 991-9000. Printing office: Fry Communications, 800 West Church Road, Mechanicsburg, PA 17319. Printed in the U.S.A. Periodical postage paid at St. Louis, MO, and additional offices. Do not return this copy but notify publisher of change of address on form 3579 as provided in Sec. 158.23 Postal Manual. Postmaster send address changes to TED, 1181 Corporate Lake Drive, St. Louis, MO 63132. Subscriptions: \$40.00/yr. for nonqualified electrical distributors and individuals affiliated with manufacturers in the field of publication. Rates for all others and foreign subscriptions upon request.

LOW COST HANGER

THE LOOP™

FOR COMMUNICATIONS CABLE

Flexible, non-metallic,
The LOOP holds a 2" to 5"
diameter bundle of CAT 5
or fiber optic cable with-
out sagging, bending or
damaging the cable!

The 2.5" **TL25** holds the
same amount of cable as a
J-hook at **1/2 the COST!**



TL50
for a
5" diameter
bundle

Patented

View video



Listed for
Air Handling
Spaces



Made in USA

Arlington 800/233-4717 • www.aifittings.com

LOW PROFILE • 4" DIAMETER

SCONCE BOX

FOR SHALLOW WALL CAVITIES OR OBSTRUCTIONS

Install a fixture
where YOU
want it...

with Arlington's
Low Profile
Sconce Box

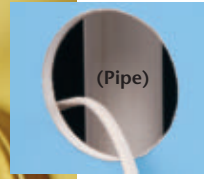

Arlington's
**Low Profile
Sconce Box**
is perfect
for retrofit
installations
with shallow

wall cavities - or obstructions
running behind the wall.

This non-metallic
box installs **FAST**
in an existing
1/2" or 5/8"
wall with a
4" hole saw.

- Mounting
wing screws
hold it firmly
in place

- Accommodates
most sconce
light canopies



FSC405R
Sconce Box

© 2014 Arlington Industries, Inc.



Patent pending

Made in USA

Arlington 800/233-4717 • www.aifittings.com

FOR POWER OR LOW VOLTAGE CABLE

CABLE WAY™

Listed as
Cable Runway
Support System

CABLE SUPPORT SYSTEM FOR NEW WORK OR RETROFIT



© 2007 Arlington Industries, Inc.



5 ft
Trough
T205

Coupling
T23C

Angle
T23A

Tee
T23T

End Cap
T23E

Try Arlington's easy to install **CABLE WAY™**
for a secure, UL Listed cable runway
support system. **System components**
get the job done quickly and easily.

Support Brackets attach
directly to framing members,
without structural damage.
They hold cables securely
in place, and open for easy
cable insertion!

The **Slide-On Trough** holds
and protects cable.
To add length, install
more sections that join
together with **Coupling**.

Angles and Tees
make turning
corners a breeze.

Push-on
End Caps
complete the job!

Flat surface
Support Bracket
T23F

Wall mount
Support Bracket
T23W

Support Bracket
T23H open

T23H closed

Scan for Info



Arlington 800.233.4717 • www.aifittings.com



Made in USA

Distributor doings



Paul Brann

Paul Brann has joined the *Buckles-Smith Materials Group* in San Jose, Calif. Brann, formerly the sales center supervisor, brings with him more than 40 years of experience.



Stacy Colella

Stacy Colella has joined *Electric Supply Center*, Boston, as a project manager and lighting estimator. Colella started her career in 1999 as an inside salesperson at Boston Light Source.



Sean Nolan

French Gerleman, St. Louis, has hired **Sean Nolan** as vice president of market development. He comes to this position with extensive experience from Grainger, where he spent 14 years.

Pennsylvania-headquartered *Fromm Electric Supply* has announced that **Jon Gerhart**, formerly vice president of sales, is now vice president of indus-

trial sales. He brings more than 30 years of industry experience to his new position.

Additionally, **Paul Chiaradia** has been hired as vice president, contractor/commercial sales. He brings more than 25 years of industry experience to the role.

Around the industry



David Kiddoo

David Kiddoo is the new executive director for the *Communications Cable & Connectivity Association*. He replaces the recently retired **Frank Peri**, who led the organization since its inception in 2007.

Manufacturer moves

Guatam Patel has been appointed as director of marketing for *Appleton Group*, a division of Emerson Industrial Automation. He brings more than 15 years of experience with him.



Brian Melka

Kohler Engines has promoted **Brian Melka** to the role of president of Engines-Americas. Melka was appointed vice president at Kohler in 2013 after numerous years in the industry.

Peter McIlroy handed over leadership of *Robroy Industries* to his two sons, **Rob McIlroy** and **Jeff McIlroy**. Rob McIlroy is now CEO, and Jeff McIlroy holds the title of vice chairman. Peter McIlroy has retained his position as board chair.



Lena Arnold

Universal Lighting Technologies recently announced the addition of **Lena Arnold** as regional sales manager for its Southwest territory. Arnold joins Universal with more than 10

JOBS WELL DONE



Nancy Goedecke

Nancy Goedecke, CEO and chair of *Mayer Electric Supply*, Birmingham, Ala., was recently honored in the *Birmingham Business Journal* as one of "Birmingham's Most Influential Executives."



Shuji Nakamura

Dr. Shuji Nakamura, co-founder of *Soraa*, was awarded the 2014 Nobel Prize in Physics. Recognizing that Nakamura's invention, the blue LED, represents a critical advancement in LED lighting, the Nobel committee explained that the innovation "has enabled bright and energy-saving white light sources."



Chad Smith

Chad Smith, vice president of product management and engineering at *Thomas & Betts*, was among those who received the "Top 40 Under 40" recognition from the *Memphis Business Journal*. The program recognizes Memphis-area professionals under age 40 for career accomplishments and charity work.

Pam Merklinger, lighting designer at *Warshauer Electric* in Tinton Falls, N.J., has become an American Lighting Association Certificate Specialist in the area of kitchen and bath lighting.

years of experience in marketing and product development. ■



Send your people news items to mbyers@naed.org.

Passings



Michael Rabe

Michael (Mike) Rabe, 59, vice president of sales and marketing at *Kendall Electric* in Grand Rapids, Mich., died on Oct. 18. He served on the NAED South Central Region Council and attended many NAED events.

Surviving are two daughters, three grandchildren, and his father. Memorial contributions may be made to the American Cancer Society.



*Our members are our
passion and our success.*

*Thank you for being part
of our association.*

HAPPY HOLIDAYS.



NATIONAL ASSOCIATION OF
ELECTRICAL DISTRIBUTORS

www.naed.org

A contribution to celebrate

by **Scott Costa**

I am going to throw a couple of numbers at you. The first is \$500,000, which is a pretty nice-sized number. It's not huge, but let's face it, there are a lot of things you can do with \$500,000—like “provide information and training products that create the most effective channel to the market for distributors, manufacturers, and their customers.”

Yes, we are right in the middle of the NAED Annual Campaign. And you know what's funny? I don't even know what the fundraising goal is this year. I just picked \$500,000 because it seems reasonable (and I need to use a nice, round number because math is not necessarily my strong suit; just ask my eighth-grade son, Sammy. I can't help with his homework...at all).

But let's take that nice round \$500,000 figure and divide it by the number of NAED member companies, which currently stands at 479.

The result is \$1,043.84.

That's not a very big number. It's \$86.99 a month.

So, if each member company can come up with \$1,043.84, we will have raised \$500,000 for the Annual Campaign.

The truth is, though, that we're better than that. I believe we can raise more than that for the future of this industry. Sure, there will be NAED members that slip through the cracks and don't donate, and there will be plenty of member companies that will donate significantly more than that. The point is, doing your part in raising a nice amount of money for an essential part of this industry will not take much away from your bottom line.

Since it's the holiday season—and the end of the calendar year—now is the time to invest \$1,043.84 in the future of this industry.

That money goes toward funding programs that are vital to the way you run your business, programs like Branch Management University, the Electrical Products Education Course (EPEC), and the Certified Electrical Professional (CEP).

The Annual Campaign also goes toward the NAED Learning Center and the mobile-friendly online classes.

That \$500,000 actually goes a very long way. Your \$1,043.84 goes a long way.

NAED has posted a suggested contribution chart at naed.org/annualcampaign. Going by the chart, many of you are “suggested” to give more than \$1,043.84. You will be recog-



nized at the NAED regional meetings and right here in *tED*, so your contributions will not go unnoticed.

Those contributions are definitely noticed by Rocky Kuchenmeister. He used NAED's educational programs to work his way up from receptionist to general manager at K/E Electrical Supply.

“Unlike many other industries, there are not many collegiate programs that focus on the needs of an electrical distributor or distribution in general,” Kuchenmeister said. “Employees who come from a business background need help on the engineering or product side of the business. Likewise, employees who took engineering courses in college need help on their soft skill development. A centralized program is less expensive and a more efficient way to deliver the needed skills for employees in electrical distribution. Standardized programs also ensure a higher level of training across the industry. Listen to these stories because your next outside salesperson, branch manager, sales manager, or CEO could be working in your offices or in your warehouse right now. Those future stars just need the tools to get them there.”

Let's do this: If you contributed, come see me at one of the upcoming NAED regional conferences or the National Meeting. Tell me you contributed so we can celebrate your contribution together, in person. An email thank you is nice, but a handshake and a toast to your generosity is a whole lot better. ■

Costa is publisher of “*tED*” magazine. He can be reached at 314-812-5311 or scosta@naed.org.



BURNDY® PATCUT2156-LI

A Cut Above

Introducing Our Largest Capacity Cutter

The key features of the new BURNDY® PATCUT2156 Series are the integrity of the blade design, advanced hydraulics, two battery platforms and great cutting capacity. Plus, the revolutionary latch-style cutting head works even in tight spaces and ensures interference-free closure for mid-span cuts. The tool's 180-degree rotation capability accesses and cuts copper and aluminum cables up to 2.00" diameter, 2156 ACSR cables, 3/4" ground rods, 9/16" EHS guy wires and 5/8" rebar.

Learn more at burndy.com.



Connecting Power to Your World™





HOW THE SOUTHWIRE-COLEMAN CABLE COMBINATION

HELPS YOU.



Scan this ad. And hear our leadership explain how this combination adds up to the quality and service you're used to, only with a lot less hassle. **You'll see that our strength truly is your strength.**

- **Download** the free Southwire®+ app from the App Store or Google Play
- **Launch** the app on your smartphone or tablet
- **Watch** this ad come to life

The Power of Connections.™

